

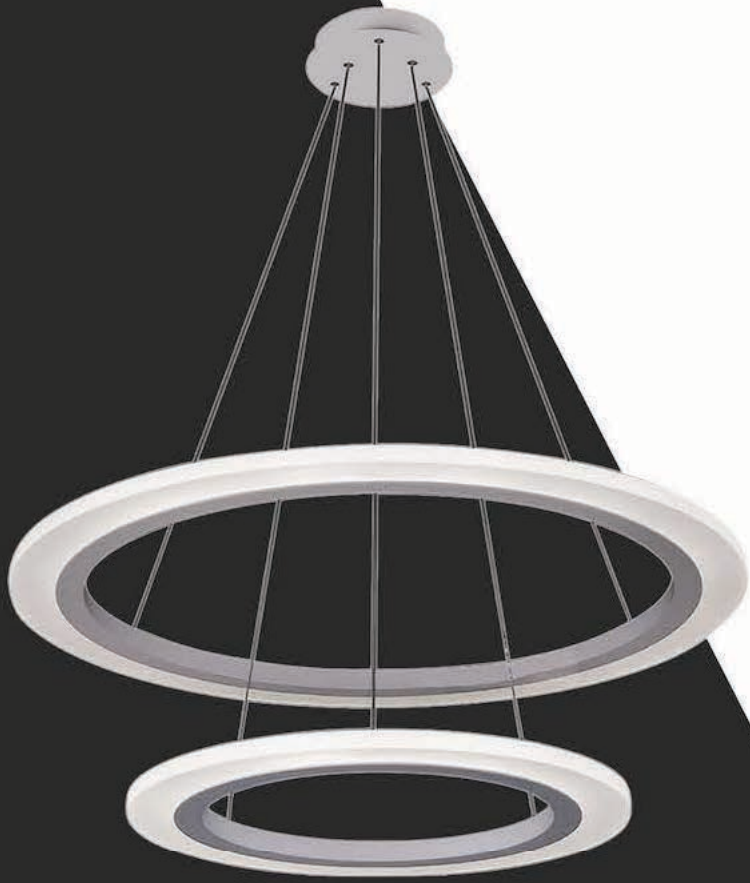

ACDCTM
DYNAMICS
www.acdc.co.za



The Leading Supplier of Industrial, Commercial & Decorative

LIGHTING SOLUTIONS

Truely unique & advanced lighting solutions for all applications

T H I N K E L E C T R I C A L

LIGHTING INDEX

| ITEMS | Page | | | | |
|------------------------------|--------------|--------------------------|----------------|----------------------------------|------------------------|
| Lamps | 1-27 | T-Bays | 43 | Up/Down Lights | 139-140 |
| LED T8 Tubes | 1-3 | Linear Highbays | 44 | Indoor | 140-147 |
| LED T5 Tubes | 3 | LED Highbays/Lowbays | 45 | Up/Down Lights | 140-141 |
| LED GU10/MR16 | 4 | LED Gas Station Lights | 46 | Wall Lights | 141 |
| LED Filament | 5 | LED Parking Bay Lights | 46 | Ceiling Lights | 142-144 |
| LED A60 | 6 | HID Lowbays | 46 | Ceiling Spot Lights | 144-146 |
| LED High Power | 6 | LED Streetlights | 47-49 | Picture Lights | 146-147 |
| LED Candle | 7 | HID Streetlights | 49-50 | Linear Ceiling | 147 |
| LED Golf Ball | 7 | PL Street Lights | 50 | Accessories | 148-162 |
| LED Reflector Lamp | 8 | Empty Street Light | 50 | Decorative Cord | 148 |
| LED E27 Downlight | 8 | Induction Street Lights | 50 | Lamp Holders | 148-151 |
| LED Compact | 8 | LED Bulkheads | 51 | Switches | 149 |
| LED PAR | 9-10 | Induction Bulkheads | 51 | LED Surge Protection | 149 |
| LED Pygmy | 10 | PL Bulkheads | 51 | Sensors | 151-155 |
| LED 2U/3U/4U | 11 | HID Bulkheads | 52 | Dimmers | 156 |
| LED Corn | 11 | Empty Bulkheads | 52 | Timers | 156 |
| LED RX7s | 11 | LED Vandal Proof | 52 | Constant Current Drivers | 157-158 |
| LED PL | 11 | Vapour Proof | 53-57 | Dimmable Electronic Transformers | 158 |
| LED G9/JC/G4/G12 | 12 | Commercial | 57-112 | Transformers | 158 |
| LED High Power Corn | 12 | Linear Lights | 57-61 | Electronic Ballasts | 159-161 |
| LED High Power T-Lamps | 13 | Office Lights | 61-62 | Magnetic Ballasts | 161-162 |
| LED High Power Lamps | 13 | Open Channel | 62-63 | Ignitors | 161-162 |
| LED Dimmable T-Lamps | 14 | LED Panel | 64-65 | Emergency | 163-168 |
| LED High Power U-Lamps | 14 | Recessed Office | 65-66 | Emergency Kits | 163 |
| LED High Power | 14 | Surface Office | 67 | Emergency Lights | 164-168 |
| LED AR111 | 15 | Downlights | 68-75, 78-81 | Specialized | 169-172 |
| LED PLL | 15 | Downlight Fittings | 76-78 | Chicken Farming Lights | 169 |
| LED Retrofit | 15 | Spot Lights | 82 | Plant Grow Lights | 169-170 |
| LED High Power Modules | 16 | Display Spot Lights | 82 | LED UVC Lights | 171 |
| LED Smart Lamps | 16-17 | Track Lights | 83-84 | Parking Bay Lights | 172 |
| LED Décor Lamps | 18 | Cabinet Lights | 84-88 | Portable | 172-176 |
| Carbon Filament | 19 | DC Lights | 89-90 | Work Lights | 172-173 |
| Pygmy- Incandescent | 19 | Strip Lights | 91-93 | Torches | 174 |
| Standard Filament | 19 | Strip Controllers | 94-95 | Head Lamps | 175 |
| Fluorescent PL / 2D | 19-20 | Strip Light Kits | 96-98 | Bicycle Lights | 175 |
| Fluorescent Tubes | 20 | Hexagon LED Tiles | 96 | Camping Lights | 176 |
| Fluorescent T8-T5 Conversion | 21 | Profiles | 99-101 | Ornamental | 176-177 |
| Infrared PAR38 | 21 | Specialized Strips | 102 | Music Lights | 176 |
| UV Lamps | 21 | Strip Connectors | 102 | Colour Changing | 176-177 |
| High Power CFL | 21 | Rigid Strip Lights | 103-105 | Festive | 177-187 |
| Compact Fluorescent | 22-24 | 230V Strips Lights | 105 | Belt Lights | 177 |
| Halogen RX7s | 24 | LED Modules | 105-106 | Rope Lights | 178-181 |
| Halogen G4/JC/JD | 25 | Neon Flex | 107-108 | Projectors | 180 |
| Incandescent Lamps | 25 | Smart Control | 109 | Curtain Lights | 182-183 |
| Dichroic Lamp | 25 | DMX Control | 110 | 3D Motif | 184-185 |
| Induction Lamps | 39 | Constant Voltage Drivers | 110-112 | Mini Rope Motif | 185-187 |
| HID | 26-27 | Outdoor | 113-140 | Display | 188 |
| Industrial | 28-55 | Floor Lights | 113 | Test Case | 188 |
| LED Floodlights | 28-33 | Wall Lights | 113 | Shelf Light | 188 |
| LED Work Lights | 33 | Deck Lights | 114 | Shower Heads | 188 |
| Portable Floodlights | 33-34 | Inground Lights | 115 | Stage | 189-190 |
| Billboard Floodlights | 34-35 | Spike Lights | 116-117 | PAR Cans | 189 |
| LED Wall Washers | 35 | Bollards | 118-119 | Search Lights | 189 |
| Induction Floodlights | 35 | Post Tops | 119-120 | Laser Lights | 190 |
| CFL Floodlights | 36 | Poles | 121 | Decorative Lighting | 191-212 |
| HID Floodlights | 36-37 | Spot Lights | 121 | Suspended Lights | 191, 193 |
| Empty Floodlights | 37 | Underwater Lights | 121-122 | Ceiling Lights | 191, 193, 194, 197-199 |
| HID Highmast Floodlights | 37 | Pool Lights | 122-124 | Desk Lights | 193-195, 197, 212 |
| HID Stadium Floodlights | 37 | Brick Lights | 124-125 | Floor Standing Lights | 193-195, 211 |
| LED Highbays | 38-40 | Foot Lights | 126 | Pendant Lights | 192, 194-209 |
| Induction Highbays | 41 | Wall Recessed | 127 | Wall Lights | 194, 196, 198 |
| HID Highbays | 42 | Wall Surface | 128 | Chandeliers | 210-211 |
| Empty Highbays | 42 | Bulkheads | 129-134 | Table lights | 212 |
| | | Wall Lights | 134-138 | | |

LED T8 TUBULAR LIGHTING

- WW - 2700K
- CW - 4200K
- DL - 6000K

**2 Year
Warranty**



Clear

**230
VAC**



Frosted

T8 LED Tubes - Glass - Supply Voltage: 230-240VAC | Non-Dimmable | CRI: 70 | Diameter: 26.3mm | Power factor: >0.95 | Efficiency: 90lm/W | Single End Wired | Can operate in temperatures between -10°C to +45°C

| Code FROSTED | Code CLEAR | Length | Lumen | Power | *Add colour to code |
|--------------|-------------|--------------|-------------|-------|---------------------------------------|
| LEDT8-A2FR-* | LEDT8-A2C-* | 600mm (2FT) | 700-800lm | 9W | WW / CW / DL / ●R / ●GN / ●BL / ●Y |
| LEDT8-A3FR-* | LEDT8-A3C-* | 900mm (3FT) | 860-950lm | 13W | |
| LEDT8-A4FR-* | LEDT8-A4C-* | 1200mm (4FT) | 1480-1600lm | 18W | |
| LEDT8-A5FR-* | LEDT8-A5C-* | 1500mm (5FT) | 1750-1900lm | 22W | |
| LEDT8-A8FR-* | - | 2365mm (8FT) | 3200lm | 36W | |

Note: Colour only available in frosted tubes.

* For DC add to code: 12VDC, 24VDC, 48VDC. **Note:** DC Tubes available in frosted and clear

- CW - 4200K
- DL - 6000K

**3 Year
Warranty**



T8 LED Tubes - PC - Supply Voltage: 85-265VAC | Non-Dimmable | CRI: 80 | Diameter: 26.3mm | PF 0.95 | Efficiency: 90lm/W | Single End Wired | With MOV Surge Protection | 270° View Angle | Can operate in temperatures between -10°C to +45°C

| Code | Length | Lumen | Power | *Add colour to code |
|----------------|--------|--------|-------|---------------------|
| LEDT8-A2FR*/PC | 600mm | 800lm | 9W | CW / DL |
| LEDT8-A4FR*/PC | 1200mm | 1600lm | 18W | CW / DL |
| LEDT8-A5FR*/PC | 1500mm | 1900lm | 22W | CW / DL |

- CW - 4200K
- DL - 6000K

**5 Year
Warranty**



T8 LED Tubes - PC / Aluminium - Supply Voltage: 85-265VAC Wide Range | Non-Dimmable | CRI: 80 | Diameter: 26.3mm | Power Factor: >0.95 | Efficiency: 160lm/W | Single End Wired | Flicker Free | Can operate in temperatures between -20°C to +45°C

| Code FROSTED | Length | Lumen | Power | *Add colour to code |
|--------------|--------------|--------|-------|---------------------|
| T8-5Y-A2FR-* | 600mm (2FT) | 1440lm | 9W | CW / DL |
| T8-5Y-A3FR-* | 900mm (3FT) | 2080lm | 13W | CW / DL |
| T8-5Y-A4FR-* | 1200mm (4FT) | 2880lm | 18W | CW / DL |
| T8-5Y-A5FR-* | 1500mm (5FT) | 3520lm | 22W | CW / DL |

- CW - 4200K
- DL - 6000K



T8 LED Tubes - Dimmable - Supply Voltage: 220-240VAC | CRI: 80 | Diameter: 26.3mm | Efficiency: 90lm/W | Power factor: >0.95 | Glass Tube | TRIAC Dimming

| Code | Length | Lumen | Power | *Add colour to code |
|--------------|--------|--------|-------|---------------------|
| DIMT8-A2FR-* | 600mm | 800lm | 9W | CW / DL |
| DIMT8-A4FR-* | 1200mm | 1600lm | 18W | CW / DL |
| DIMT8-A5FR-* | 1500mm | 1900lm | 22W | CW / DL |

- CW - 4200K
- DL - 6000K



T8 LED Tubes - Single Pin - Supply Voltage: 230VAC | Diameter: 26mm | Glass | Power factor: >0.95

| Code Frosted | Length | Lumens | Power | *Add colour to code |
|----------------|--------------|--------|-------|---------------------|
| LEDT8SP-A4FR-* | 1200mm (4ft) | 1710lm | 18W | CW / DL |
| LEDT8SP-A5FR-* | 1500mm (5ft) | 2090lm | 22W | CW / DL |
| LEDT8SP-A8FR-* | 2365mm (8ft) | 3420lm | 36W | CW / DL |

LED T8 TUBULAR LIGHTING

- CW - 4200K
- DL - 6000K



Could be used inside waterproof fittings or behind a diffuser

T8 Microwave Motion Sensing SMD LED Tubes - 85-265VAC | Intelligent microwave motion sensing technology | Motion detection angle: 180° | Motion detection range: ≤10m

| Code | Length | Lumen | Power | Replaces T8 Lamp | *Add colour to code |
|----------------|--------|-------------|-------|------------------|---------------------|
| LEDT8MW-A2FR-* | 600mm | 800-850lm | 9W | 18W (2FT) | CW / DL |
| LEDT8MW-A3FR-* | 900mm | 1450-1500lm | 15W | 30W (3FT) | CW / DL |
| LEDT8MW-A4FR-* | 1200mm | 1750-1850lm | 18W | 36W (4FT) | CW / DL |
| LEDT8MW-A5FR-* | 1500mm | 2100-2200lm | 22W | 58W (5FT) | CW / DL |

- CW - 4200K
- DL - 6000K



T8 PIR Motion Sensing SMD LED Tubes - 85-265VAC | PIR detection angle: 120° | PIR Range: 5-7m | Turn off delay: 30 seconds | Switch on time: 0.5s from detection

| Code | Length | Lumen | Power | Replaces T8 lamp | *Add colour to code |
|---------------|--------|-------------|-------|------------------|---------------------|
| LEDT8S-A2FR-* | 600mm | 800-850lm | 9W | 18W (2FT) | WW / CW / DL |
| LEDT8S-A3FR-* | 900mm | 1100-1200lm | 13W | 30W (3FT) | WW / CW / DL |
| LEDT8S-A4FR-* | 1200mm | 1750-1850lm | 19W | 36W (4FT) | WW / CW / DL |
| LEDT8S-A5FR-* | 1500mm | 2100-2200lm | 22W | 58W (5FT) | WW / CW / DL |

- CW - 4200K
- DL - 6000K



2 Year Warranty

T8 Waterproof LED Tubes - PC IP65 - 180 - 265VAC | Non-Dimmable | CRI > 80 | Diameter 26mm | Power Factor 0.95 | Efficiency: 100lm/W | Operating Temp -10° to +45°C | Waterproof PC End Caps | Connection wire length 500mm

| Code | Length | Lumen | Power | *Add colour to code |
|---------------|--------|--------|-------|---------------------|
| XGY-T8-A2FR-* | 600mm | 850lm | 9W | CW / DL |
| XGY-T8-A3FR-* | 900mm | 1500lm | 15W | CW / DL |
| XGY-T8-A4FR-* | 1200mm | 3600lm | 18W | CW / DL |
| XGY-T8-A5FR-* | 1500mm | 5800lm | 22W | CW / DL |



T8 Food Display (Butcher) SMD LED Tubes - 85-265VAC | These lamps are specially designed to ensure that food is displayed in an appetizing light. The light generated by the lamp makes meat, bread and other food look fresh and appealing. Also because LED lamps have no glass in their construction they are especially suitable for the food industry.

| Code | Length | Power | Replaces T8 Lamp |
|--------------|--------|-------|------------------|
| LEDT8BL-A2FR | 600mm | 9W | 18W (2FT) |
| LEDT8BL-A3FR | 900mm | 15W | 30W (3FT) |
| LEDT8BL-A4FR | 1200mm | 18W | 36W (4FT) |
| LEDT8BL-A5FR | 1500mm | 22W | 58W (5FT) |

See page 99 for shelf tag with butcher strip light

- CW - 4200K
- DL - 6000K



3 Year Warranty

T8 Medical LED Tubes IP65 - 85-265VAC | With COI (Cyanosis Observation Index) < 2.5, Lantis LED Tubes are suitable for medical lighting application within hospitals in operating theatres, patient treatment rooms, consulting rooms, accident / trauma emergency areas that require close colour rendition of skin | RA > 90

| Code | Length | Lumen | Power | Replaces T8 lamp | *Add colour to code |
|---------------|--------|---------------|-------|------------------|---------------------|
| LTS-T8-A2FR-* | 600mm | 1000 - 1100lm | 10W | 18W (2FT) | CW / DL |
| LTS-T8-A4FR-* | 1200mm | 1500 - 1600lm | 16W | 36W (4FT) | CW / DL |
| LTS-T8-A5FR-* | 1500mm | 2200 - 2500lm | 23W | 58W (5FT) | CW / DL |

T8 UVC LED Tubes - Input Voltage: 85-265VAC | 120° Beam Angle | Wavelength Range 270-280nm | Peak Wavelength 275nm | Radiant Flux max 5mW | Ceramic Substrate and Quartz Glass | Highly effective against inactivating and destroying the DNA of micro organisms found in mould, germs, bacteria and viruses.

| Code | Wattage | Spectrum | Size (mm) |
|--------------|---------|----------|------------|
| LEDT8-UVC-A2 | 9W | UVC | 600 (2ft) |
| LEDT8-UVC-A4 | 15W | UVC | 1200 (4ft) |
| LEDT8-UVC-A5 | 20W | UVC | 1500 (5ft) |

NEW

Lamps

LIGHTING

LED T8 TUBULAR LIGHTING



T8 LED for Walk-In Freezers - 220-240VAC | Significant energy & maintenance cost savings | Improved illumination of products | Reduced heat | Environmentally-friendly - no mercury | No glass breakage | No UV light | Aluminium Backing & PC Diffuser | Operating temp.: -10 ~ 40°C

| Code | Length | Power |
|-----------|--------|-------|
| LETT8-26W | 1700mm | 26W |



T8 Plant Growing SMD LED Tubes - 85-265VAC | 75% Blue, 25% Red | Plant grow lamps have LED's that produce light in Blue (450nm) and Red (660nm) wavelengths that are ideal for promoting photo-biological processes in plants. These lamps can be used wherever plants do not receive enough natural light or in agricultural applications. For more see page 167-168

| Code | Length | Power | Replaces T8 Lamp |
|--------------|--------|-------|------------------|
| LEDT8PG-A2FR | 600mm | 9W | 18W (2FT) |
| LEDT8PG-A3FR | 900mm | 15W | 30W (3FT) |
| LEDT8PG-A4FR | 1200mm | 18W | 36W (4FT) |
| LEDT8PG-A5FR | 1500mm | 22W | 58W (5FT) |

- CW - 4200K
- DL - 6000K



T8 LED Tubes - Maintained Emergency - With Internal Battery | Supply Voltage: 230VAC | Maintained emergency lighting luminaires are built to be active continuously in every day life, and through the event of a power cut, irrespective if switch is on or off | Emergency Back-Up Time: 1 Hour @ 300lm

| Code | Length | Lumen | Power | *Add colour to code |
|--------------------|--------|--------|-------|---------------------|
| EMG-M-LEDT8-A2FR-* | 600mm | 800lm | 9W | CW / DL |
| EMG-M-LEDT8-A4FR-* | 1200mm | 1600lm | 18W | CW / DL |
| EMG-M-LEDT8-A5FR-* | 1500mm | 1900lm | 22W | CW / DL |

NEW

- CW - 4200K
- DL - 6000K



T8 LED Tubes - Non-Maintained Emergency - With Internal Battery | Supply Voltage: 230VAC | Emergency Back-Up Time: 1 Hour @ 300lm | **Emergency only works when switch is on and mains fail** | Tube to be wired independantly

| Code | Length | Lumen | Power | *Add colour to code |
|------------------|--------|--------|-------|---------------------|
| EMG-LEDT8-A2FR-* | 600mm | 800lm | 9W | CW / DL |
| EMG-LEDT8-A4FR-* | 1200mm | 1600lm | 18W | CW / DL |
| EMG-LEDT8-A5FR-* | 1500mm | 1900lm | 22W | CW / DL |

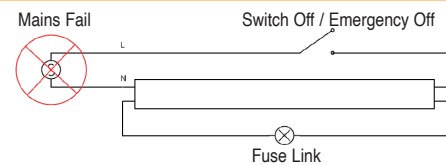
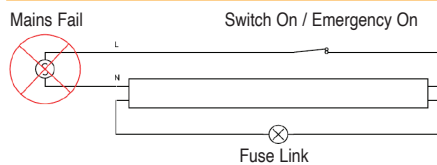

Accessories for T8 Tubes

| Code | Description |
|------------|---------------------------------------|
| EL-FL | Fuse Link to replace Starter |
| LEDT8-CLIP | CLIP for mounting of Tube in Lightbox |
| LEDT8-LLH | Loose Lamp Holder |
| LEDT8-CONL | 1.5m T8 Connector Lead |

LED T5 TUBULAR LIGHTING

- CW - 4200K
- DL - 6000K

LED T5 Tubes - 220-240VAC | Diameter: 19mm | Power factor: >0.95 | Efficiency: 80lm/W | Material: Aluminium + PC

| Frosted Code | Length | Wattage | Lumen | *Add colour to code |
|--------------|--------------|---------|--------|---------------------|
| LEDT5-A2FR-* | 550mm (2FT) | 7W | 580lm | CW / DL |
| LEDT5-A3FR-* | 900mm (3FT) | 14W | 1120lm | CW / DL |
| LEDT5-A4FR-* | 1150mm (4FT) | 16W | 1280lm | CW / DL |
| LEDT5-A5FR-* | 1450mm (5FT) | 20W | 1600lm | CW / DL |

INTERNAL DRIVER

LED GU10 - 230VAC

- WW - 2700K
- CW - 4200K
- DL - 6000K

Non-Dimmable

| | | | | |
|---------------------|-----------------------------------------------------------------------------------|-----------------------------------------------------------------------------------|------------------------------------------------------------------------------------|-------------------------------------------------------------------------------------|
| |  |  |  |  |
| | Single | Single | 5 Pack | Single |
| Code | SMD-GU10-3W* | SMD-GU10-6W* | LED-GU10-6W*/5 | HS-GU10-5W* |
| Wattage | 3W | 6W | 6W | 5W |
| Lumens | 240lm | 480lm | 480lm | 450lm |
| Beam Angle | 120° | 120° | 120° | 45° |
| *Add Colour to Code | CW / DL / ●R / ●GN / ●BL / ●Y | WW / CW / DL | WW / CW / DL | WW / CW |

- WW - 2700K
- CW - 4200K
- DL - 6000K

Non-Dimmable

| | | | |
|---------------------|-----------------------------------------------------------------------------------|------------------------------------------------------------------------------------------------------------------------|-------------------------------------------------------------------------------------|
| |  | NEW 5 Year Warranty  |  |
| | Single | | Single |
| Code | KL-GU10-7W* | HS-GU10-5W*-5Y | GU10-3528-60* |
| Wattage | 7W | 5W | 3W |
| Lumens | 500lm | 350lm | 380lm |
| Beam Angle | 38° | 48° | 120° |
| *Add Colour to Code | WW / CW | WW / CW / DL | WW / CW / DL |

- WW - 2700K
- CW - 4200K
- DL - 6000K



Dimmable

| | | | | |
|---------------------|-------------------------------------------------------------------------------------|--------------------------------------------------------------------------------------------------------------------------|--------------------------------------------------------------------------------------|---------------------------------------------------------------------------------------|
| |  | NEW 5 Year Warranty  |  |  |
| | | | | |
| Code | DIM-KL-GU10-7W* | DIM-GU10-5W*-5Y | DIM-MS-GU10-5W* | DIM-GU10-5W* |
| Wattage | 7W | 5W | 5W | 5W |
| Lumens | 560lm | 350lm | 380lm | 450lm |
| Beam Angle | 38° | 48° | 120° | 38° |
| *Add Colour to Code | WW / CW / DL | WW / CW / DL | WW / CW / DL | WW / CW |

- WW - 2700K
- CW - 4200K
- DL - 6000K

1.5hrs Emergency

Emergency 3 Step Dimming

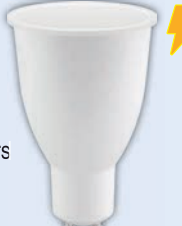
| | | | |
|---------------------|------------------------------------------------------------------------------------------------|------------------------------------------------------------------------------------------------|--------------------------------------------------------------------------------------------------|
| | NEW  | NEW  | NEW  |
| | | | 135lm - 2.5hrs 60lm - 5hrs 24lm - 7hrs |
| Code | EMG-GU10-3W* | EMG-GU10-5W* | EMG-DIM-GU10-6W* |
| Wattage | 3W | 5W | 5W |
| Lumens | Normal: 190lm Emergency: 85lm | Normal: 550lm Emergency: 120lm | Normal: 650lm Emergency: 135/60/24lm |
| Beam Angle | 120° | 120° | 120° |
| *Add Colour to Code | WW / CW / DL | WW / CW / DL | WW / CW / DL |

LED MR16 - 12V

Non-Dimmable

- WW - 2700K
- CW - 4200K
- DL - 6000K



12V



12V



12V



12V

| Code | SMD-MR16-6W-* | HS-MR16-5W-* | KL-MR16-7W-* | MR16-3528-60-* |
|---------------------|---------------|--------------|--------------|----------------|
| Wattage | 6W | 5W | 7W | 3W |
| Lumens | 480lm | 350lm | 500lm | 380lm |
| Beam Angle | 120° | 45° | 38° | 120° |
| *Add Colour to Code | WW / CW / DL | WW / CW | WW / CW | WW / CW |

Non-Dimmable

- WW - 2700K
- CW - 4200K
- DL - 6000K



12V



12V

5 Year Warranty



230VAC

| Code | HS-MR16-1X3W-* | HS-MR16-5W-*.5Y | HS-MR16-1X3W-*.230 |
|---------------------|-------------------------------|-----------------|--------------------|
| Wattage | 3W | 5W | 3W (1 x 3W) |
| Lumens | 200lm | 350lm | 240lm |
| Beam Angle | 60° | 48° | 28° |
| *Add Colour to Code | WW / CW / ●R / ●GN / ●BL / ●Y | WW / CW / DL | WW / CW |

- WW - 2700K
- CW - 4200K
- DL - 6000K

Dimmable



230VAC



12V



230VAC

| Code | HS-MR16-3X1W-*.230 | DIM-MR16-35-60-* | DIM-MR16-35-60-*.230 |
|---------------------|--------------------|------------------|----------------------|
| Wattage | 3W (3 x 1W) | 4W | 4W |
| Lumens | 200lm | 380lm | 380lm |
| Beam Angle | 60° | 120° | 120° |
| *Add Colour to Code | WW / CW | CW / DL | CW |

- WW - 2700K
- CW - 4200K
- DL - 6000K

Dimmable



12V



12V



12V

| Code | DIM-MS-MR16-5W-* | DIM-MR16-5W-* | DIM-KL-MR16-7W-* |
|---------------------|------------------|---------------|------------------|
| Wattage | 5W | 5W | 7W |
| Lumens | 380lm | 450lm | 670lm |
| Beam Angle | 120° | 38° | 38° |
| *Add Colour to Code | WW / CW / DL | WW | WW / CW |

LED IMITATION FILAMENT LAMP

LED Ball Lamps - Supply Voltage: 220-240VAC | CRI: 80 | 360° lighting to directly replace traditional incandescent lamp 20W, 40W & 60W. Special elongated LED encapsulation technique allows LED to give the same effect as an incandescent tungsten filament lamp.

| Code | Code (Dimmable) | LED Power | Base | Lumen | Beam | Colour |
|--------------|-----------------|-----------|------|-------|------|---------|
| B60-4W-E27-* | - | 4W | E27 | 450lm | 360° | WW / CW |
| B60-4W-B22-* | - | 4W | B22 | 450lm | 360° | WW / CW |
| B60-6W-E14-* | - | 6W | E14 | 700lm | 360° | WW / CW |
| B60-6W-E27-* | - | 6W | E27 | 700lm | 360° | WW / CW |
| B60-6W-B22-* | - | 6W | B22 | 700lm | 360° | WW / CW |

LED Candle Lamp • Supply Voltage: 220-240VAC • CRI: 80

| | | | | | | |
|--------------|------------------|----|-----|-------|------|---------|
| C35-2W-E14-* | - | 2W | E14 | 225lm | 360° | WW / CW |
| C35-2W-E27-* | - | 2W | E27 | 225lm | 360° | WW / CW |
| C35-2W-B22-* | - | 2W | B22 | 225lm | 360° | WW / CW |
| C35-4W-E14-* | DIM-C35-4W-E14-* | 4W | E14 | 350lm | 360° | WW / CW |
| C35-4W-E27-* | - | 4W | E27 | 450lm | 360° | WW / CW |
| C35-4W-B22-* | - | 4W | B22 | 450lm | 360° | WW / CW |

LED Flame Candle Lamp • Supply Voltage: 220-240VAC • CRI: 80

| | | | | | | |
|---------------|-------------------|----|-----|-------|------|---------|
| C35L-2W-E14-* | DIM-C35L-2W-E14-* | 2W | E14 | 245lm | 360° | WW / CW |
| C35L-2W-E27-* | - | 2W | E27 | 245lm | 360° | WW / CW |
| C35L-2W-B22-* | - | 2W | B22 | 245lm | 360° | WW / CW |
| C35L-4W-B22-* | - | 4W | B22 | 450lm | 360° | WW / CW |

LED Golf Ball Lamp • Supply Voltage: 220-240VAC • CRI: 80

| | | | | | | |
|--------------|---|----|-----|-------|------|---------|
| G45-2W-E14-* | - | 2W | E14 | 245lm | 360° | WW / CW |
| G45-2W-E27-* | - | 2W | E27 | 245lm | 360° | WW / CW |
| G45-2W-B22-* | - | 2W | B22 | 245lm | 360° | WW / CW |
| G45-4W-E27-* | - | 4W | E27 | 450lm | 360° | WW / CW |

LED Reflective Lamp • Supply Voltage: 220-240VAC • CRI: 80

| | | | | | | |
|--------------|---|----|-----|-------|------|---------|
| R50-2W-E14-* | - | 2W | E14 | 245lm | 120° | WW / CW |
| R63-4W-E27-* | - | 4W | E27 | 450lm | 120° | WW / CW |
| R63-4W-B22-* | - | 4W | B22 | 450lm | 120° | WW / CW |
| R80-4W-E27-* | - | 4W | E27 | 450lm | 120° | WW / CW |
| R80-4W-B22-* | - | 4W | B22 | 450lm | 120° | WW / CW |

LED Ball Lamp • Supply Voltage: 220-240VAC • CRI: 80

| | | | | | | |
|---------------|---|----|-----|-------|------|---------|
| G125-4W-E27-* | - | 4W | E27 | 450lm | 360° | WW / CW |
| G125-4W-B22-* | - | 4W | B22 | 450lm | 360° | WW / CW |
| G125-6W-E27-* | - | 6W | E27 | 750lm | 360° | WW / CW |
| G125-6W-B22-* | - | 6W | B22 | 750lm | 360° | WW / CW |

LED Pear Shape Lamp • Supply Voltage: 220-240VAC • CRI: 80

| | | | | | | |
|---------------|---|----|-----|-------|------|---------|
| ST64-4W-E27-* | - | 4W | E27 | 450lm | 360° | WW / CW |
| ST64-4W-B22-* | - | 4W | B22 | 450lm | 360° | WW / CW |
| ST64-6W-E27-* | - | 6W | E27 | 700lm | 360° | WW / CW |
| ST64-6W-B22-* | - | 6W | B22 | 700lm | 360° | WW / CW |

*Add colour to code: ○ CW (Cool White) 4000-4200K or ○ WW (Warm White) 2700-3000K

A60 LED FILAMENT PLANT GROW LAMP - E27

Input Voltage: 180 - 265VAC | Dimensions: Ø60 x 108mm | Full Colour Spectrum for general use | Ideal for greenhouse glass or plastic, Planting factory, Hydroponic shelves, Home Planting.

| Code | Wattage | Colour Spectrum | PPF (400-700nm) | PAR Watt (W) (400-700nm) | EFF (PPF) (400-700nm) |
|---------------|---------|-----------------|-----------------|--------------------------|-----------------------|
| XGY-A60-8-E27 | 8W | Full Spectrum | >12 μ mol | 0.3 - 0.5mW | >1.5 μ mol/s/W |

LED LAMPS (TO REPLACE MERCURY BLENDED LAMPS)

○ CW - 4200K
○ DL - 6000K
HLT

Supply Voltage: 90-265VAC

| Code | Wattage | Base | Lumens | Size (mm) | Replace | Colour |
|---------------|---------|------|--------|------------|---------|---------|
| HLT-E40-15W-* | 15W | E40 | 2200lm | Ø46 x 195 | - | CW / DL |
| HLE-E40-20W-* | 20W | E40 | 2800lm | Ø90 x 225 | 80W | CW / DL |
| HLE-E40-30W-* | 30W | E40 | 3800lm | Ø90 x 225 | 160W | CW / DL |
| HLE-E40-40W-* | 40W | E40 | 5800lm | Ø118 x 290 | 250W | CW / DL |

*Add colour to code: ○ CW (Cool White) 4000-4200K or ○ DL (Day Light) 6000K

LED LAMPS

| E27 & B22 Non-Dimmable | | A60 B22 | A60 E27 | A60 B22 | A60 E27 | Code | Wattage | Base | Lumen | Beam Angle | *Add Colour to Code |
|----------------------------------------------|--|------------|---------|------------|---------|--------------------|---------|------|--------|------------|---------------------|
| Supply Volts: 230VAC | | | | | | T-LED-5W-E27-* | 5W | E27 | 450lm | 270° | WW / CW / DL |
| ○ WW - 2700K ○ CW - 4200K ○ DL - 6000K | | 5W, 7W, 9W | | 15W | 15W | T-LED-5W-B22-* | 5W | B22 | 450lm | 270° | WW / CW / DL |
| | | | | 170-260VAC | | T-LED-7W-E27-* | 7W | E27 | 540lm | 270° | WW / CW / DL |
| | | | | | | T-LED-7W-B22-* | 7W | B22 | 540lm | 270° | WW / CW / DL |
| | | | | | | HS-E27-10W-* | 9W | E27 | 720lm | 160° | WW / CW / DL |
| | | | | | | HS-B22-10W-* | 9W | B22 | 720lm | 160° | WW / CW / DL |
| | | | | | | HS-E27-15W-* | 15W | E27 | 1200lm | 160° | WW / CW / DL |
| | | | | | | HS-B22-15W-* | 15W | B22 | 1200lm | 160° | WW / CW / DL |
| | | | | | | HS-E27-25W-DL | 25W | E27 | 2200lm | 120° | DL |
| | | | | | | HS-E27-35W-DL | 35W | E27 | 2900lm | 120° | DL |
| | | | | | | HS-E40-50W-DL | 50W | E40 | 4000lm | 120° | DL |
| | | | | | | HS-E40-70W-DL | 70W | E40 | 5600lm | 120° | DL |
| | | | | | | HS-E40-100W-DL | 100W | E40 | 8000lm | 120° | DL |
| | | | | | | DIM-A60-S6W-E27-* | 6W | E27 | 500lm | 270° | WW / CW / DL |
| | | | | | | DIM-A60-S6W-B22-* | 6W | B22 | 500lm | 270° | WW / CW / DL |
| | | | | | | DIM-A60-S10W-E27-* | 10W | E27 | 850lm | 160° | WW / CW / DL |
| | | | | | | DIM-A60-S10W-B22-* | 10W | B22 | 850lm | 160° | WW / CW / DL |
| | | | | | | DL-5W-E27-* | 5W | E27 | 400lm | 270° | WW / CW / DL |
| | | | | | | DL-5W-B22-* | 5W | B22 | 400lm | 270° | WW / CW / DL |
| | | | | | | DL-10W-E27-* | 10W | E27 | 900lm | 270° | WW / CW / DL |
| | | | | | | DL-10W-B22-* | 10W | B22 | 900lm | 270° | WW / CW / DL |
| | | | | | | A60-LSM-E27-10-* | 10W | E27 | 806lm | 270° | WW / CW / DL |
| | | | | | | A60-LSM-B22-10-* | 10W | B22 | 806lm | 270° | WW / CW / DL |
| | | | | | | HS-E27-PIR-* | 5W | E27 | 400lm | 180° | WW / CW |
| | | | | | | SLL-L2403D* | 3W | E27 | 280lm | 160° | CW |
| | | | | | | SLL-L2405D* | 5W | E27 | 470lm | 160° | CW |
| | | | | | | SLL-L2407D* | 7W | E27 | 1000lm | 160° | CW |

E27 & B22
Dimmable
Supply Volts: 230VAC

LED A60 Lamp - Various Sensing Options

Non-Dimmable
Supply Volts: 220-240VAC

DL Day/Night Sensor
A60-LSM Day/Night & Motion Sensor
HS-E27-PIR Motion Sensor

DC LED Lamps - Cool White

Non-Dimmable
12VDC / 24VDC

L2403 L2405 L2407

* Add Voltage to Code: 12VDC, * 24VDC

| | Value Packs - 230VAC | | Colour lamps - 230VAC | | LED UV A60 | |
|----------------------------------------------|----------------------|----------------|-------------------------------|---------------------|----------------------|-----------|
| ○ WW - 2700K ○ CW - 4200K ○ DL - 6000K | | | | | | |
| | LED-A60-5W-*/2 | LED-A60-7W-*/2 | E27-C60LED-* | B22-C60LED-* | LEDE27-M | UV-E27-3W |
| Code | LED-A60-5W-*/2 | LED-A60-7W-*/2 | E27-C60LED-* | B22-C60LED-* | LEDE27-M | UV-E27-3W |
| Wattage | 5W | 7W | 3W | 3W | 1W | 3W |
| Base | *E27 / *B22 | *E27 / *B22 | E27 | B22 | E27 | E27 |
| Lumens | 450lm | 540lm | - | - | - | - |
| Beam Angle | 270° | 270° | 270° | 270° | 270° | 200° |
| *Add colour to code | WW / CW / DL | WW / CW / DL | WW / CW / ●R / ●GN / ●BL / ●Y | ●R / ●GN / ●BL / ●Y | Auto Colour Changing | UV |

| | Mosquito Repellent - 230VAC | | Insect Killing Lamps | | Boiler Inspection - 32VAC | |
|----------------------------------------------|-----------------------------|---------------------------|----------------------|------------|---------------------------|-------------------|
| ○ WW - 2700K ○ CW - 4200K ○ DL - 6000K | | | | | | |
| | MR-LED-A60-*/5W | MR-LED-A60-*/5W | RW-MKL-15W | SP-DYT90 | SP-DYT90 | BIL-10W-E27-32VAC |
| Code | MR-LED-A60-*/5W | MR-LED-A60-*/5W | RW-MKL-15W | SP-DYT90 | SP-DYT90 | BIL-10W-E27-32VAC |
| Wattage | 5W | 5W | 15W | 7W | 7W | 10W |
| Base | *E27 / *B22 | *E27 / *B22 | E27 | Hook | Hook | E27 |
| Lumens | 300lm | 300lm | 400lm | 200lm | 200lm | 800lm |
| Beam Angle | 270° | 270° | 275° | 270° | 270° | 270° |
| Colour Temperature | Mosquito Repellent Yellow | Mosquito Repellent Yellow | CW (6000K) | CW (4200K) | CW (4200K) | CW (4200K) |

LED CANDLE LAMPS - 230VAC

| | Non-Dimmable | | | | | Coloured Lamps | Value Packs |
|------------------------------|-----------------|-----------------|-----------------|-----------------|-------------------------------|----------------|-------------------|
| ○ WW - 2700K ○ CW - 4200K | | | | | | | |
| Code E14 | T-LEDB35R-E14-* | - | - | T-LEDC35L-E14-* | SP-E14-CLH37-* | | T-LEDB35R-E14-*/3 |
| Code E27 | - | T-LEDB35R-E27-* | - | - | - | | - |
| Code B22 | - | - | T-LEDB35R-B22-* | - | - | | - |
| Wattage | 3W | 3W | 3W | 3W | 1.6W | | 3W |
| Base | E14 | E27 | B22 | E14 | E14 | | E14 / E27 / B22 |
| Lumens | 245lm | 245lm | 245lm | 245lm | - | | 245lm |
| Beam Angle | 180° | 180° | 180° | 180° | 180° | | 180° |
| *Add colour to code | WW / CW | WW / CW | WW / CW | WW / CW | WW / CW / ●R / ●GN / ●BL / ●Y | | WW / CW |

| | Dimmable | | | | |
|------------------------------|-----------|---------------|---------------|---------------|---------------|
| ○ WW - 2700K ○ CW - 4200K | | | | | |
| Code | LEDC212-* | LEDC35E-E27-* | LEDC35E-B22-* | LEDC35E-B15-* | LEDC35L-E14-* |
| Wattage | 5W | 5W | 5W | 5W | 5W |
| Base | E14 | E27 | B22 | B15D | E14 |
| Lumens | 400lm | 400lm | 400lm | 400lm | 400lm |
| Beam Angle | 270° | 270° | 270° | 270° | 270° |
| *Add colour to code | WW / CW | WW / CW | WW / CW | WW | WW / CW |

LED GOLF BALL LAMPS - 230VAC

| | Non-Dimmable | | | Dimmable |
|------------------------------|-----------------|-----------------|-----------------|-----------|
| ○ WW - 2700K ○ CW - 4200K | | | | |
| Code | T-LEDG50R-E14-* | T-LEDG50R-E27-* | T-LEDG50R-B22-* | LEDA35E-* |
| Wattage | 3W | 3W | 3W | 3W |
| Base | E14 | E27 | B22 | E27 |
| Lumens | 245lm | 245lm | 245lm | 200lm |
| Beam Angle | 180° | 180° | 180° | 270° |
| *Add colour to code | WW / CW | WW / CW | WW / CW | WW / CW |

| | Colour Lamps | | Value Packs | |
|------------------------------|-------------------------------|------------------------------------------------------|-------------------|-------------------|
| ○ WW - 2700K ○ CW - 4200K | | | | |
| Code | LE45-0.6-E27-*/2 | LE45-0.6-B22-** | T-LEDG50R-E27-*/3 | T-LEDG50R-B22-*/3 |
| Wattage | 1W | 1W | 3W | 3W |
| Base | E27 | B22 | E27 | B22 |
| Lumens | - | - | 245lm | 245lm |
| Beam Angle | 270° | 270° | 180° | 180° |
| *Add colour to code | WW / CW / ●R / ●GN / ●BL / ●Y | WW / CW / ●R / ●GN / ●BL / ●Y / ●O (Orange) / ●●●●●O | WW / CW | WW / CW |

*Add pack size to code: /2 (2 Pack), /5 (5 Pack - only mixed colours)

LED LAMPS - 230VAC

Non-Dimmable Reflector Type

- WW - 2700K
- CW - 4200K

| <td> <td> </td></td> | <td> </td> | | | | | |
|----------------------|--------------|--------------|--------------|----------------|--------------|---------------|
| Code | LED-R39-3W-* | LED-R50-3W-* | LED-R50-6W-* | LED-R63-4.5W-* | LED-R63-8W-* | LED-R80-10W-* |
| Wattage | 3W | 3W | 6W | 4.5W | 8W | 10W |
| Base | E14 | E14 | E14 | E27 | E27 | E27 |
| Lumens | 240lm | 240lm | 540lm | 360lm | 720lm | 850lm |
| Beam Angle | 160° | 160° | 160° | 160° | 160° | 160° |
| *Add colour to code | WW / CW | WW | WW / CW | WW | WW / CW | WW / CW |

Dimmable Reflector Type

- WW - 2700K
- CW - 4200K

| <td> </td> | | | | |
|---------------------|--------------|--------------|--------------|---------------|
| Code | DIM-R39-3W-* | DIM-R50-6W-* | DIM-R63-8W-* | DIM-R80-10W-* |
| Wattage | 3W | 6W | 8W | 10W |
| Base | E14 | E14 | E27 | E27 |
| Lumens | 240lm | 540lm | 720lm | 850lm |
| Beam Angle | 160° | 160° | 160° | 160° |
| *Add colour to code | WW / CW | WW / CW | WW / CW | WW / CW |

Non-Dimmable G95 (Ø95mm)

Non-Dimmable G125 (Ø125mm)

- WW - 2700K
- CW - 4200K

| <td> </td> | | | | |
|---------------------|---------------|---------------|----------------|----------------|
| Code | G95-E27-12W-* | G95-E27-15W-* | G120-E27-15W-* | G120-E27-18W-* |
| Wattage | 12W | 15W | 15W | 18W |
| Base | E27 | E27 | E27 | E27 |
| Lumens | 960lm | 1200lm | 1200lm | 1600lm |
| Beam Angle | 270° | 270° | 270° | 270° |
| *Add colour to code | WW / CW | WW / CW | WW / CW | WW / CW |

Non - Dimmable JDR Lamps

Dimmable JDR

- WW - 2700K
- CW - 4200K

| <td> <td></td> </td> | <td></td> | | | | | |
|----------------------|-------------|---------------|------------------------|---------------|-------------|---------|
| Code | T-LEDJDRR-* | HS-JDR-1X3W-* | HS-JDR-3X1W-* | HS-JDR-3X2W-* | HS-JDR-5W-* | DIM-E27 |
| Wattage | 4W | 3W | 3W | 6W | 5W | 6W |
| Base | E27 | E27 | E27 | E27 | E27 | E27 |
| Lumens | 250-280lm | 200lm | 240lm | 340-360lm | 330-350lm | 380lm |
| Beam Angle | 280° | 60° | 38° | 38° | 60° | 38° |
| *Add colour to code | WW / CW | WW / CW | WW / CW / ● R / ● Y | WW / CW | WW / CW | WW / CW |

LED COMPACT LAMPS

- WW - 2700K
- CW - 4200K

| Code | LP-T48-2-0.6W | LP-T48-2-2W | LP-T48-2-4W | LP-T45-4-0.6W | LP-T45-4-1.4W |
|---------------------|---------------|-------------|-------------|---------------|---------------|
| Wattage | 0.6W | 2W | 4W | 0.6W | 1.4W |
| Base | E27 | E27 | E27 | E27 | E27 |
| Lumens | 45lm | 150lm | 300lm | 45lm | 105lm |
| Beam Angle | 180° | 180° | 180° | 180° | 180° |
| *Add colour to code | CW | CW | CW | CW | CW |

PAR LED LAMPS

- WW - 2700K
- CW - 4000K



PAR - Supply Voltage 220-240VAC | IP65

| Code | Wattage | Lumens | Base | Beam Angle | *Add Colour to Code |
|---------------------------|---------|--------|------|------------|---------------------|
| PAR20-LED-9W-* | 9W | 720lm | E27 | 60° | WW / CW |
| PAR30 Non-Dimmable | | | | | |
| PAR30-LED-13W-* | 13W | 1000lm | E27 | 60° | WW / CW |
| PAR38 Non-Dimmable | | | | | |
| PAR38-LED-17W-* | 17W | 1360lm | E27 | 60° | WW / CW |
| PAR38-LED-22W-* | 22W | 1800lm | E27 | 60° | WW / CW |



PAR LED Colour - Supply Voltage 220-240VAC | IP65

| | | | | | |
|---------------------|-----|--------|-----|-----|-------------------|
| PAR20-4407-* | 6W | 450lm | E27 | 42° | ●R / ●G / ●B / ●Y |
| PAR30 Colour | | | | | |
| PAR30-4206-* | 10W | 800lm | E27 | 42° | ●R / ●G / ●B / ●Y |
| PAR38 Colour | | | | | |
| PAR38-4306-* | 15W | 1300lm | E27 | 30° | ●R / ●G / ●B / ●Y |

- WW - 2700K
- CW - 4000K



PAR Lamps - Supply Voltage 85-260VAC | IP65 | Same shape as original PAR

| | | | | | |
|----------------|-----|--------|-----|-----|-------------------------------|
| LEDPAR20-* | 5W | 425lm | E27 | 60° | WW / CW / ●R / ●GN / ●BL / ●Y |
| LEDPAR30-* | 9W | 765lm | E27 | 60° | ●BL / ●Y |
| LEDPAR38-12W-* | 12W | 1170lm | E27 | 60° | ●●●M (Colour Changing) |

- WW - 2700K
- CW - 4000K



PAR 38 Anti Glare - Supply Voltage 220-240VAC

| | | | | | |
|----------------|-----|-------------|-----|-----|---------|
| KL-PAR38-18W-* | 18W | 1200-1300lm | E27 | 40° | WW / CW |
|----------------|-----|-------------|-----|-----|---------|

PAR 38 Colour Lamp - Supply Voltage 220-240VAC

| | | | | | |
|--------------|-----|--------|-----|-----|---------------|
| HS-PAR38-18W | 18W | 1200lm | E27 | 60° | ●R / ●BL / ●Y |
|--------------|-----|--------|-----|-----|---------------|

Dimmable PAR Lamps - 230VAC

- WW - 2700K
- CW - 4000K



PAR 20 - Supply Voltage 220-240VAC | IP65

| Lamp Code | Wattage | Lumens | Base | Beam Angle | *Add Colour to Code |
|-----------------|---------|-----------|------|------------|---------------------|
| DIM-PAR20-10W-* | 10W | 830-890lm | E27 | 60° | WW / CW |

PAR 30 - Supply Voltage 220-240VAC | IP65

| | | | | | |
|-----------------|-----|------------|-----|------|---------|
| DIM-PAR30-12W-* | 12W | 930-1000lm | E27 | 120° | WW / CW |
|-----------------|-----|------------|-----|------|---------|

PAR 38 Narrow Angle - Supply Voltage 220-240VAC | IP65

| | | | | | |
|-----------------|-----|--------|-----|-----|---------|
| LCM8106-60DIM-* | 18W | 1440lm | E27 | 60° | WW / CW |
|-----------------|-----|--------|-----|-----|---------|

PAR 38 Wide Angle - Supply Voltage 220-240VAC | IP65

| | | | | | |
|------------------|-----|--------|-----|------|---------|
| LCM8106-160DIM-* | 18W | 1440lm | E27 | 160° | WW / CW |
|------------------|-----|--------|-----|------|---------|



PAR 20 VARI FOCAL - Supply Voltage 110-240VAC | Colour Temperature 5000K | Variable Beam Angle

| Code | Base | LED Qty/W | Total LED Watts | Lumen for CW | Lumen for WW | Beam Angle | Colour Temperature |
|------------|------|-----------|-----------------|--------------|--------------|------------|--------------------|
| LR20-04W01 | E27 | 1 x 4W | 4W | 90-160lm | 90-160lm | 15-40° | 5000K |
| LR20-10W01 | E27 | 1 x 10W | 10W | 360-520lm | 360-520lm | 15-40° | 5000K |

Accessories

| Code | Description |
|--------------|-------------------------------------------------------------|
| LR30-LHA-B22 | Interchangeable adaptor from E27 to B22. For LR20 and LR30. |



Special PAR30 - Supply Voltage 85-260VAC | Colour Temperature 5000K

| Code | Base | LED Qty/W | Total LED Watts | Lumen for CW | Lumen for WW | Beam Angle | Colour Temperature |
|------------|------|-----------|-----------------|--------------|--------------|------------|--------------------|
| LR30-12W01 | E27 | 3 x 4W | 12W | ± 600lm | ± 600lm | 45° | 5000K |
| LR30-12W03 | E27 | 3 x 4W | 12W | ± 600lm | ± 600lm | 15° | 5000K |

Lamps are supplied with E27 bases. The base can be changed to B22 with a lampholder adaptor.

Accessories

| Code | Description |
|--------|-------------------------------------------------------------|
| LHA-02 | Interchangeable adaptor from E27 to B22. For LR20 and LR30. |

PAR LED LAMPS

- WW - 2700K
- CW - 4200K



PAR56 - 230VAC | IP20

| Code | Base | LED Qty/W | Total LED Watts | Lumen for CW | Lumen for WW | Beam Angle | *Add Colour to Code |
|---------------|------|-----------|-----------------|--------------|--------------|------------|---------------------|
| HS-PAR56-32-* | E27 | 16 x 2W | 32W | ±2600lm | ±2400lm | 120° | WW / CW |



LED PAR38 Plant Grow - IP65

| Code | Base | Watts | Lumen |
|------------------|------|-------|-------|
| LED-PAR38-12W-PG | E27 | 12W | 171lm |

- 75% Red, 25% Blue
- The wave length for red is 662nm, for blue is 447nm

LED LAMPS - 230VAC

Pygmy Lamps - 2 Per Pack

| Code | SL-0.5W-E14/2 | SL-2.5W-E14/2 | LR-0.5W-E14-*/2 | LR-0.5W-15D-*/2 | LR-0.5W-15S-*/2 |
|------------------------|---------------|---------------|----------------------------------------------------------|-----------------|-----------------|
| Wattage | 0.5W | 2.5W | 0.5W | 0.5W | 0.5W |
| Base | E14 | E14 | E14 | BA15D | BA15S |
| Lumens | 15lm | 80lm | 80lm | 30-40lm | 30-40lm |
| Size (mm) | Ø27 x 56 | Ø27 x 68 | Ø18.5 x 45 | Ø18.5 x 45 | Ø18.5 x 45 |
| Colour | WW | WW | CW | CW | CW |
| Supply Voltage: 230VAC | | | *Add Voltage to Code: 12VAC/DC, 24VAC/DC, 110VAC, 230VAC | | |

Lamps

| Code | LR-1W-E14 230VAC/2 | LR-1W-15S 230VAC/2 | LR-1W-E14 12V/2 | LR-1W-15S 12V/2 | LR-1W-15D 12V/2 |
|-----------|--------------------|--------------------|-----------------|-----------------|-----------------|
| Wattage | 1W | 1W | 1W | 1W | 1W |
| Base | E14 | BA15S | E14 | BA15S | BA15D |
| Lumens | 80lm | 80lm | 80lm | 80lm | 80lm |
| Size (mm) | 18,5 x 45mm | 18,5 x 45mm | 18,5 x 45mm | 18,5 x 45mm | 18,5 x 45mm |
| Colour | 4000K | 4000K | 4000K | 4000K | 4000K |

Pygmy Lamps Colour

| Code | LED-E14-* | P19S-E2701-* | LM-LED*-*/2 |
|-----------|----------------------------------------------------------|--------------|----------------------------------------------------|
| Wattage | 2.7W | 1.3W | 2W |
| Base | E14 | E27 | BA15D |
| Lumens | 300lm | 117lm | 180lm |
| Size (mm) | Ø31 x 79 | Ø37 x 65 | Ø22 x 54 |
| Volts | *Add Voltage to Code: 12VAC/DC, 24VAC/DC, 110VAC, 230VAC | | *Add Voltage to Code: 12VDC, 24VDC, 110VAC, 230VAC |

*Add colour to code: ○ W (White), ● R (Red), ● GN (Green), ● BL (Blue), ● Y (Yellow)

LED U LAMPS

| LED | FLUORESCENT | INCANDESCENT |
|-------|-------------|--------------|
| 3W → | 7W → | 35W → |
| 5W → | 11W → | 50W → |
| 7W → | 15W → | 70W → |
| 9W → | 19W → | 90W → |
| 12W → | 25W → | 120W → |
| 16W → | 33W → | 160W → |
| 20W → | 38W → | 200W → |
| 30W → | 60W → | 300W → |

- WW - 2700K
- CW - 4200K



LED 2U

| Code E27 | Code B22 | Supply Volts | Wattage | Length | Lumens | *Add Colour to Code |
|----------------|----------------|-----------------|---------|--------|--------|---------------------|
| LED2U-3W-E27-* | LED2U-3W-B22-* | 230, 12, 24, 48 | 3W | 105mm | 240lm | WW / CW |
| LED2U-5W-E27-* | LED2U-5W-B22-* | 12, 24, 48 | 5W | 115mm | 400lm | WW / CW |

LED 3U

| | | | | | | |
|-----------------|-----------------|-----------------|-----|-------|--------|---------|
| LED3U-5W-E27-* | LED3U-5W-B22-* | 230 | 5W | 135mm | 400lm | WW / CW |
| LED3U-7W-E27-* | LED3U-7W-B22-* | 230, 12, 24, 48 | 7W | 145mm | 560lm | WW / CW |
| LED3U-9W-E27-* | LED3U-9W-B22-* | 230, 12, 24, 48 | 9W | 145mm | 720lm | WW / CW |
| LED3U-12W-E27-* | LED3U-12W-B22-* | 230 | 12W | 170mm | 960lm | WW / CW |
| LED3U-16W-E27-* | LED3U-16W-B22-* | 230 | 16W | 175mm | 1280lm | WW / CW |

LED 4U

| | | | | | | |
|-----------------|-----------------|-----|-----|-------|--------|---------|
| LED4U-20W-E27-* | LED4U-20W-B22-* | 230 | 20W | 175mm | 1600lm | WW / CW |
| LED4U-30W-E27-* | LED4U-30W-B22-* | 230 | 30W | 255mm | 2550lm | WW / CW |

* Add DC Voltages to code: -12VDC, -24VDC, -48VDC

LED CORN

Supply Volts
230VAC

- WW - 2700K
- CW - 4200K
- DL - 6000K



| Code | SDES-906-* | SDES-915-* | SDES-930-* | FX-GRL-4.5W-* | FX-GRL-6.5W-* | FX-GRL-12.5W-* | FX-GRL-18W-* |
|---------------------|------------|------------|------------|---------------|---------------|----------------|--------------|
| Wattage | 6W | 16W | 30W | 4.5W | 6.5W | 12.5W | 18W |
| Base | E27 | E27 | E27 | E27 | E27 | E27 | E27 |
| Lumens | 480lm | 1280lm | 3000lm | 360-420lm | 480-540lm | 960-1050lm | 1420-1500lm |
| Size (mm) | Ø38 x 113 | Ø43 x 160 | Ø82 x 225 | Ø32 x 103 | Ø41 x 111 | Ø61 x 146 | Ø84 x 157 |
| *Add colour to code | CW / DL | CW / DL | CW / DL | WW / CW | WW / CW | WW / CW | WW |

LED PENDANT LAMPS

Supply Volts
230VAC

- CW - 4200K

* Add Wattage to Code:
16W, 33W



R7s Lamps

- DL - 6000K

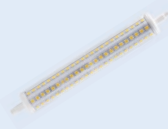

R7s Lamps - 360° Beam Angle

- DL - 6000K



| Code | LED-CL18*-CW | R7S-LED-15W | LED-R7S-5W | LED-R7S-8W | LED-R7S-10W | LED-R7S-15W |
|--------------------|------------------------|-------------|------------|------------|-------------|-------------|
| Wattage | *16W *33W | 15W | 5W | 8W | 10W | 15W |
| Base | E27 E27 | R7s | R7s | R7s | R7s | R7s |
| Lumens | 1440lm 2970lm | 1450lm | 500lm | 900lm | 1100lm | 1650lm |
| Size (mm) | Ø140 x 90 Ø254 x 127 | 189 | Ø13 x 78 | Ø13 x 118 | Ø13 x 118 | Ø13 x 118 |
| Colour Temperature | 4200K 4200K | 6000K | 6000K | 6000K | 6000K | 6000K |

LED PL LAMPS

Supply Volts: 220-240VAC

- WW - 2700K
- CW - 4200K
- DL - 6000K



| Code | FBPL-6DW-* | FBPL-8DW-* | FBPL-10DW-* | LEDPL-5W-* | LEDPL-10W-* | LEDPL-12W-* | LEDPL-15W-* |
|---------------------|------------|------------|-------------|--------------|--------------|-------------|-------------|
| Wattage | 6W | 8W | 10W | 5W | 10.5W | 12W | 15W |
| Lumen | 560lm | 750lm | 940lm | 425lm | 900lm | 1100lm | 1400lm |
| Base | G24d | G24d | G24d | G24d | G24d | G24d | G24d |
| Size (mm) | Ø35 x L145 | Ø35 x L166 | Ø35 x L181 | Ø44 x 98 | Ø34 x 150 | Ø35 x 140 | Ø35 x 140 |
| *Add colour to code | 6000K | 6000K | 6000K | WW / CW / DL | WW / CW / DL | CW / DL | CW / DL |

*Add - 'EM' to code for Emergency PL Lamp. c/w driver. 3 Hr backup. eg FBPL-10DW-EM

LED LAMPS

| | | | | | | | | | | | | |
|-----------------------------------------------------------------------------|--------------------|--------------------|--------------------|------------------------|-------------------------|----------------------|----------------------|--|------------------|--|------------|--|
| G9 LED Lamps Supply Volts 230VAC ○ WW - 2700K ○ CW - 4200K | 2 per pack | | 2 per pack | | 2 per pack | | 2 per pack | | | | | |
| | | | | | Dimmable | | | | | | | |
| Code | G9-2W-*/2 | G9-3W-*/2 | SG9-5W-*/2 | DIM-G9-3W-*/2 | | | | | | | | |
| Watts | 2W | 3W | 5W | 3W | | | | | | | | |
| Lumen | 200lm | 320lm | 380lm | 300lm | | | | | | | | |
| Size (mm) | Ø16 x 48 | Ø23 x 63 | Ø16 x 60 | Ø19 x 55 | | | | | | | | |
| *Add colour to code | WW / CW | WW / CW | WW / CW | WW / CW | | | | | | | | |
| JC LED Lamps Supply Volts 12V ○ WW - 2700K ○ CW - 4200K | 2 / blister pack | | 2 / blister pack | | 2 / blister pack | | 2 per pack | | | | | |
| | | | | | Dimmable | | | | | | | |
| Code | JC-0.6W-*/2 | JC-1.3W-*/2 | JC-1.5W-*/2 | JC-2W-*/2 | DIM-JC-1.5W-*/2 | | | | | | | |
| Watts | 0.6W | 1.3W | 1.5W | 2W | 1.5W | | | | | | | |
| Lumen | 40lm | 80lm | 100lm | 150lm | 120lm | | | | | | | |
| Size (mm) | Ø10 x 33 | Ø12 x 31 | Ø14 x 31.5 | Ø14 x 31.5 | Ø12 x 31 | | | | | | | |
| *Add colour to code | WW / CW | WW / CW | WW / CW | WW / CW | WW / CW | | | | | | | |
| G4 LED Lamps ○ WW - 2700K ○ CW - 4200K | 2 / blister pack | | 2 / blister pack | | 2 / blister pack | | 2 / blister pack | | 1 / blister pack | | 2 per pack | |
| | | | | | | | Dimmable | | | | | |
| Code | G4-1W-*/2 | G4-2.3W-*/2 | G4-3W-*/2 | G4-2.3W-*/2 230 | SHL-G4-1.5W-*/2 | SHL-G4-3W-* | DIM-G4-2W-*/2 | | | | | |
| Power | 1W | 2.3W | 3W | 2.3W | 1.5W | 3W | 2W | | | | | |
| Lumen | 50lm | 210lm | 270lm | 210lm | 160lm | 230lm | 200lm | | | | | |
| Size (mm) | Ø10 x 35 | Ø16 x 44 | Ø16 x 44 | Ø16 x 44 | Ø10 x 36 | Ø16 x 45 | Ø16 x 44 | | | | | |
| *Add colour to code | WW / CW | WW / CW | WW / CW | WW / CW | WW / CW | WW / CW | WW / CW | | | | | |
| G4 LED Lamps Supply Volts 8-30VAC ○ WW - 2700K ○ CW - 4200K | Side Pins | | | Bottom Pins | | G12 LED Lamps | | | | | | |
| | | | | | | | | | | | | |
| Code | EL-G4-1/2 | EL-G4-2/2 | EL-G4-4/2 | HL-G12-10W-* | HL-G12-10W-*/230 | | | | | | | |
| Power | 1.2W | 1.5W | 1.8W | 10W | 10W | | | | | | | |
| Lumen | 70lm | 100lm | 120lm | 1200lm | 1200lm | | | | | | | |
| Size (mm) | Ø23 | Ø28 | Ø32 | Ø26 x 118 | Ø26 x 118 | | | | | | | |
| *Add colour to code | CW (4000K) | CW (4000K) | CW (4000K) | WW / CW | WW / CW | | | | | | | |

LED CORN LIGHTS

High Power Lamps Supply Voltage: 100-250VAC Beam Angle: 360° PF>0.9



| Code No Fan | Code Fixed Fan | Code Replaceable Fan | Watts | Lumen | Base | Size (mm) |
|---------------|----------------|----------------------|--------|---------|------|-----------|
| FX-BL-20W-WW | - | HS-JN01-020-* | 20W | 1650lm | E27 | Ø96x230 |
| FX-BL-30W-WW | - | HS-JN01-030-* | 30W | 2500lm | E27 | Ø96x250 |
| FX-BL-40W-WW | - | HS-JN01-040-* | 40W | 3500lm | E40 | Ø96x290 |
| FX-BL-50W-CW | - | - | 50W | 4100lm | E40 | Ø96x310 |
| FX-BL-60W-WW | - | HS-JN01-060-* | 60W | 5800lm | E40 | Ø96x340 |
| FX-KBL-80W-CW | - | HS-JN01-075-* | 75/80W | 7200lm | E40 | Ø117x350 |
| FX-KBL-100W-* | HS-JN05-100-* | - | 100W | 9200lm | E40 | Ø117x390 |
| FX-KBL-120W-* | HS-JN05-120-* | - | 120W | 11000lm | E40 | Ø117x430 |

*Add colour to code: ○ CW (Cool White) 5500-6000K, ○ WW (Warm White) 3000K.
For spare replacement fan use code: HS-JN01-FAN

HP T-LAMPS

- WW - 2700K
- CW - 4200K
- DL - 6500K



Non-Dimmable T-Lamps | 110V Lamp has Over Voltage Protection. Only operates between 110-140VAC

| Code | Wattage | *Add Base to Code | Lumens | Supply Voltage | Size (mm) | *Add Colour to Code |
|-------------------|---------|-------------------|---------|----------------|------------|---------------------|
| TP-DL-5W-* | 5W | E27 | 470lm | 170-265VAC | Ø50 x 100 | WW / CW |
| TP-DL-5W-CW 110V | 5W | E27 | 470lm | 110VAC | Ø50 x 100 | CW |
| TP-DL-10W-* | 10W | E27 | 870lm | 170-265VAC | Ø60 x 119 | WW/CW/DL |
| TP-DL-10W-CW 110V | 10W | E27 | 870lm | 110VAC | Ø60 x 115 | CW |
| TP-DL-15W-* | 15W | E27 | 1350lm | 170-265VAC | Ø70 x 130 | WW / CW |
| XH-T95-20W-*.* | 20W | *E27 / *B22 | 1600lm | 170-265VAC | Ø80 x 145 | WW / CW |
| TP-DL-20W-CW 110V | 20W | E27 | 1600lm | 110VAC | Ø80 x 142 | CW |
| XH-T95-30W-*.* | 30W | *E27 / *B22 | 2400lm | 170-265VAC | Ø115 x 202 | WW / CW |
| XH-T110-40W-*.* | 40W | *E27 / *B22 | 3600lm | 170-265VAC | Ø120 x 200 | WW / CW |
| XH-T149-60W-* | 60W | E40 | 4800lm | 170-265VAC | Ø160 x 280 | WW/CW/DL |
| XH-T135-80W-* | 80W | E40 | 7200lm | 170-265VAC | Ø151 x 255 | WW/CW/DL |
| XH-T150-100W-* | 100W | E40 | 9000lm | 170-265VAC | Ø148 x 260 | WW/CW/DL |
| XH-T158-150W-* | 150W | E40 | 12000lm | 170-265VAC | Ø160 x 288 | WW/CW/DL |

NEW

- DL - 6500K



High Power T-Lamps - Optional Reflector | Lamps supplied with E27-E40 Adaptor

| Code | Wattage | Base | Lumens | Supply Voltage | Size (mm) | Colour Temp. |
|---------------|---------|-----------|---------|----------------|------------|--------------|
| CRD-HP80W | 80W | E27 & E40 | 7600lm | 230VAC | Ø140 x 300 | DL(6500K) |
| CRD-HP100W | 100W | E27 & E40 | 9000lm | 230VAC | Ø140 x 300 | DL(6500K) |
| HN-HB001-150W | 150W | E27 & E40 | 13500lm | 230VAC | Ø160 x 325 | DL(6500K) |
| HN-HB001-200W | 200W | E27 & E40 | 18000lm | 230VAC | Ø160 x 325 | DL(6500K) |

Accessories Code Description

| | |
|--------------|------------------------------------------------------|
| HN-HB001-REF | Optional Reflector for use with HN-HB001-100W / 200W |
| CRD-HP-REF | Optional Reflector for use with CRD-HP80W / 100W |

- DL - 6500K



High Power Lamps

| Code | Wattage | Base | Lumens | Supply Voltage | Size (mm) | Colour Temp. |
|----------------|---------|------|---------|----------------|------------|--------------|
| L-BL-0490 | 55W | E27 | 4200lm | 85-265VAC | Ø100 x 218 | DL(6500K) |
| L-BL-0494 | 65W | E40 | 5400lm | 85-265VAC | Ø100 x 300 | DL(6500K) |
| LES-ED120-80W | 80W | E40 | 8800lm | 100-240VAC | Ø120 x 285 | DL(6500K) |
| LES-ED120-100W | 100W | E40 | 11000lm | 100-240VAC | Ø120 x 285 | DL(6500K) |
| HBL-CNL-65W | 65W | E40 | 5400lm | 230VAC | Ø145 x 225 | DL(6500K) |
| HBL-CNL-85W | 85W | E40 | 7200lm | 230VAC | Ø170 x 275 | DL(6500K) |
| HBL-CNL-105W | 100W | E40 | 9500lm | 230VAC | Ø190 x 275 | DL(6500K) |

High Power Lamp c/w Reflector - 230VAC | 6500K

| | | | | | | |
|---------------|------|-----|--------|--------|------------|-----------|
| HN-HB001-65W | 65W | E40 | 5525lm | 230VAC | Ø345 x 110 | DL(6500K) |
| HN-HB001-85W | 85W | E40 | 7225lm | 230VAC | Ø400 x 300 | DL(6500K) |
| HN-HB001-105W | 100W | E40 | 8500lm | 230VAC | Ø420 x 330 | DL(6500K) |

HIGH POWER T-LAMPS

- WW - 2700K
- CW - 4200K
- DL - 6500K



DTP



L-BL-1001-40W

Dimmable T-Lamps

| Code | Wattage | Base | Lumens | Supply Voltage | Size (mm) | *Add Colour to Code |
|------------------------------------------------------------------------------------------------------------------------------------------------|---------|-----------|-----------|----------------|------------|---------------------|
| DTP-DL-5W-* | 5W | E27 | 300-350lm | 230VAC | Ø58 x 144 | WW / CW |
| DTP-DL-10W-* | 8W | E27 | 650-700lm | 230VAC | Ø68 x 165 | WW / CW |
| Automatic Dim - Energy Saving mode or Regular Mode Sensor Range 7m Lamp will automatically dim down to save energy when no movement | | | | | | |
| L-BL-1001-40W | 40W | E27 & E40 | 3500lm | 100-240VAC | Ø100 x 218 | DL(6500K) |

HIGH POWER U-LAMPS

Input Voltage: 90-265VAC | Beam Angle 320° | Colour Temp 6500K

E27-E40 Adaptor



20W



30W



40-50W



60W



70W



100-120W

| Code | Wattage | Base | Lumens | Size |
|------------|---------|-----------|---------|------------|
| HP-2U-20W | 20W | E27 | 1700lm | Ø46 x 194 |
| HP-4U-30W | 30W | E27 | 2550lm | Ø72 x 223 |
| HP-4U-40W | 40W | E27 | 3600lm | Ø72 x 240 |
| HP-4U-50W | 50W | E27 & E40 | 4200lm | Ø72 x 256 |
| HP-5U-60W | 60W | E27 & E40 | 5100lm | Ø88 x 265 |
| HP-5U-70W | 70W | E27 & E40 | 5900lm | Ø88 x 295 |
| HP-8U-100W | 100W | E40 | 9000lm | Ø125 x 310 |
| HP-8U-120W | 120W | E40 | 10200lm | Ø125 x 320 |

NEW

LED HIGH POWER

3 Year Warranty

160 lm/w



Long Stem Lamp - IP20 Input Voltage: 180-280VAC | 6000K | PF>0.95 | CRI>80 | 5kV Surge Protection | Aluminium Body + PC Lens | 90° Beam Angle | Suitable for Highbays

| Code | Wattage | Base | Lumens | Size (mm) |
|----------------|---------|------|---------|------------|
| RW-HB-E40-100W | 100W | E40 | 16000lm | Ø220 x 246 |
| RW-HB-E40-150W | 150W | E40 | 24000lm | Ø261 x 248 |
| RW-HB-E40-200W | 200W | E40 | 32000lm | Ø311 x 253 |



LS-GL-100W-DL

120° Adjustable Light Panel - IP20 Input Voltage: 220-240VAC | 6000K | Material: Die-Cast Aluminium + PC Beam Angle 120° | CRI>80 | Colour Temp 5500K | Suitable for Garage, warehouse and office

| Code | Wattage | Base | Lumens | Size (mm) |
|---------------|---------|------|---------|-----------------|
| LS-GL-60W-DL | 60W | E27 | 6000lm | 232 x 214 x 100 |
| LS-GL-100W-DL | 100W | E27 | 10000lm | 266 x 266 x 112 |



UFO LED Lamp - IP20 Input Voltage: 85-265VAC | Thermal Conductivity Nylon | Beam Angle 120° | CRI 70 | Suitable for Garage, Warehouse and Office

| Code | Wattage | Base | Lumens | Size (mm) |
|--------------|---------|------|--------|-----------|
| L-UFO-30W-DL | 30W | E27 | 3000lm | 150 x 100 |
| L-UFO-50W-DL | 50W | E27 | 5000lm | 220 x 100 |

LED AR111 LAMPS

| | Non - Dimmable | | | Coloured | Dimmable | |
|--------------------------------------------------------------------------------------|-------------------------|-----------------------|------------------------|---------------------------|-----------------------|-----------------------|
| <ul style="list-style-type: none"> ○ WW - 2700K ○ CW - 4200K | | | | | | |
| Code | L058-AR111-12W-* | LEDAR111-12W-* | MDS-AR111-12W-* | LEDAR111-9W-* | KL-AR111-12W-* | KL-AR111-15W-* |
| Wattage | 12W | 12W | 12W | 9W | 12W | 15W |
| Base | GU10 | G53 | GU10 | GU10 | G53 | GU10 |
| Supply Voltage | 230VAC | 12 - 24VAC/DC | 230VAC | 230VAC | 12VAC/DC | 230VAC |
| Lumens | 850 - 1100lm | 1000lm | 1000lm | 800lm | 850-1100lm | 1275lm |
| Beam Angle | 45° | 45° | 120° | 45° | 60° | 40° |
| *Add colour to code | WW / CW | WW / CW | WW / CW | ●R / ●GN/ ●BL / ●Y | WW / CW | WW / CW |

LED PLL LAMPS

- WW - 2700K
- CW - 4200K

LED PLL Lamp Series



| Code | PLL-226-8W-* | PLL-321-16W-* | PLL-415-20W-* | PLL-541-25W-* |
|---------------------|----------------|----------------|----------------|----------------|
| Watts | 8W | 16W | 20W | 25W |
| Voltage | AC100-240V | AC100-240V | AC100-240V | AC100-240V |
| Lumen | 675lm | 1380lm | 1700lm | 2120lm |
| Size (mm) | Ø41.4 x L210.1 | Ø41.4 x L404.1 | Ø41.4 x L526.1 | Ø41.4 x L526.1 |
| *Add colour to code | WW / CW | WW / CW | WW / CW | WW / CW |

LED RETROFIT LAMPS

OTHER LED LAMPS

LED 2D Type

- WW - 2700K
- CW - 4200K
- DL - 6000K



EMG

Emg time: 3-4Hrs



EMG

Charge Time: 13hrs
Emg Time: 3hrs
Battery: 3.6Ah



NEW

GX53



LED Circline Lamps

- G10q Base
- Internal Driver



| Code | 2D-LEDR-14W-* | 2D-LEMG-16W-* | EMG-CL-18W-DL | EMG-CL-24W-DL | LGX53-8W-* | TOP-C225-16W | TOP-C299-20W |
|---------------------|----------------|-------------------|---------------------------|---------------------------|----------------|--------------|--------------|
| Watts | 14W | 16W | 18W | 24W | 8W | 16W | 20W |
| Voltage | 100-240V | 100-240V | 230VAC | 230VAC | 170-260V | 90-264V | 90-264V |
| Lumen | 1150lm | 1700lm | 1800lm Normal / 400lm Emg | 2400lm Normal / 400lm Emg | 620lm | 1280lm | 1660lm |
| Size (mm) | Ø224 x 24H | 200L x 200W x 31H | Ø179 | Ø221 | Ø75 x 29H | Ø225 x 30H | Ø299 x 30H |
| Base Type | GR10q | GR8 | Wired | Wired | GX53 | G10q | G10q |
| *Add colour to code | WW / CW | WW / CW | 6000K | 6000K | WW / CW | 6000K | 6000K |

LED RETROFIT MODULES

Supply Volts
175 - 265VAC

- WW - 2700K
- CW - 4200K
- DL - 6000K



Magnetic LED Module for Bulkheads

| Code | Power | Lumen | Size (mm) | * Add Colour to code |
|-------------|-------|--------|-----------|----------------------|
| CP-FD-9W-* | 9W | 680lm | Ø130 x 24 | WW / CW / DL |
| CP-FD-18W-* | 18W | 1350lm | Ø170 x 24 | WW / CW / DL |

- CW - 4200K
- DL - 6500K

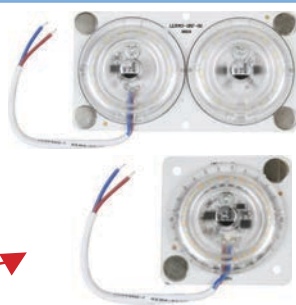
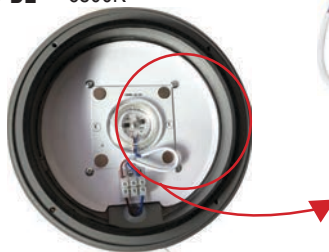

Universal LED Module - Input Voltage: 230VAC | Simple Retrofit Solution | 160° Beam Angle | Driver less | 3 Mounting Options; Magnetic, Screws, Double sides heat conductive tape (Tape Included)

| Code | Wattage | Lumens | Size (mm) | * Add Colour to code |
|------------|---------|--------|-----------|----------------------|
| H-HB-12W-* | 12W | 1150lm | 80 x 80 | CW / DL |
| H-HB-24W-* | 24W | 2300lm | 80 x 160 | CW / DL |
| H-HB-36W-* | 36W | 3500lm | 140 x 140 | CW / DL |
| H-HB-45W-* | 45W | 4300lm | 170 x 170 | CW / DL |

LED MODULES IP67

**5Year
Warranty**



Input Voltage: 36VDC | 6063 Aluminium Alloy Material | Light transmittance is more than 95% | Standardized electrical interface, convenient to install | 6500K | Power Supply not Supplied.

Beam Angle:

- A: 54° / 48°
- B: 90° / 50°
- C: 90°
- D: 60°

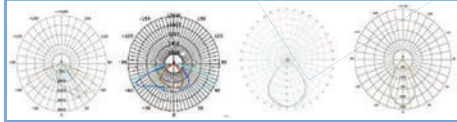

Optical Design

| Code | Wattage | Lumens | Current | Beam Angle | Size (mm) |
|------------|---------|--------|---------|-------------|---------------|
| MS02A-50-A | 50W | 6500lm | 1500mA | 145° / 100° | 300 x 76 x 54 |
| MS02A-50-B | 50W | 6500lm | 1500mA | 150° / 70° | 300 x 76 x 54 |
| MS02A-50-C | 50W | 6500lm | 1500mA | 90° | 300 x 76 x 54 |
| MS02A-50-D | 50W | 6500lm | 1500mA | 40° | 300 x 76 x 54 |

SMART CONTROLLABLE LED LAMPS



Dimmable and Colour Change Lamps - c/w 24 Key Remote

| Code | Colour | Base | Watts | Volts |
|-----------------|-------------------------------|--------------|-------|------------|
| HS-MR16-RGB 12V | Multi Colour Changing | GU5.3 (MR16) | 3W | 12VAC/DC |
| HS-GU10-RGB/W | Multi Colour Changing + White | GU10 | 5W | 110-265VAC |



Dimmable



RGB



White

Bluetooth or WIFI LED Speaker Lamps - Input Voltage: 100-240VAC | E27 base | True Wireless Stereo | Smart Device Control | App for IOS & Android



| Code | LMS-20 | LMS-40 |
|--------------------|------------------------------------------------|------------------------------------------------------------------------------------------------|
| Description | Bluetooth LED Speaker - Master & Slave | WIFI Speaker - Single Speaker Multiple speakers can be grouped in app for True Stereo |
| LED Watts | 9W | 7W |
| LED Lumens | 600lm | 450lm |
| Colour Temp | 2700K - Warm White | 2700K - Warm White |
| Light Beam Angle | 120° | 120° |
| Audio Power | 15 Watts (Max.) @ 4ohm | 15 Watts (Max.) @ 4ohm |
| Speaker | 2" Full Range | 2" Full Range |
| Maximum SPL | 90dB (93dB for Master Speaker + Slave Speaker) | 90dB |
| Communication Type | Bluetooth V4.0, Dual Mode | WiFi 2.402 - 2.480 GHz |

Adjustable Colour Temperature LED Lamps - Flick Switch off/on to change Supply Volts: 220-240VAC from one colour temperature to the next.



| Code | Wattage | Base | Lumen | Beam Angle |
|-----------------|---------|------|-------|------------|
| CTA-A60-9W-E27 | 9W | E27 | 750lm | 180° |
| CTA-A60-12W-E27 | 12W | E27 | 900lm | 180° |

Adjustable: 3000K - Warm White ; 4200K - Cool White ; 6500K - Daylight

NEW

SMART WIFI LED BULB

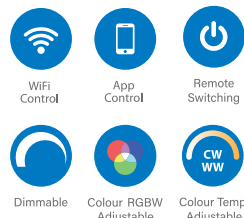

Input Voltage: 230VAC | Smart Bulb gives you the ability to control lighting in your home remotely, group and set your room atmosphere for different occasions with your smart Phone.

| Code | Wattage | Lumens | Base |
|---------------|---------|--------|-----------|
| AS-WF-A60-* | 10W | 800lm | E27 / B22 |
| AS-WF-GU10-5W | 5W | 330lm | GU10 |

* Add Base to code: **E27, B22**

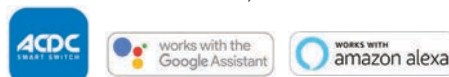

SMART CONTROLLABLE LED LAMPS



ZYZY-LB-6WR Kit

Note: The ZYZY-LB-6WBB lamps are only compatible with the ZYZY-LB-6WRR remote.

Colour Temperature Adjustable
Daylight to Warm White
and Dimmable



Remote Controlled Lamps - Colour temperature adjustment & dimmable

Supply voltage: 85-265VAC | Lamps are dimmable from 0-100%. Colour Temp can be set from warm white to daylight (2700K-7000K) | Night light function, lamps can be controlled individually or in a group.

| Code | Description |
|---------------------|-----------------------------------------------------------------------------------------------------------------------------------------------------------------------------------------------------------------|
| ZYZY-LB-6WR | Starter kit including two ZYZY-LB-6WBB lamps and one ZYZY-LB-6WRR remote control. |
| ZYZY-LB-6WBB | 6W LED lamp, dimmable and colour temperature adjustable. 510-560lm: Dependant on the colour temperature. Can be paired with 4 remotes. Can be added to the kit. No limit of number of lamps per Remote Control. |
| ZYZY-LB-6WRR | Remote control. Functions: ON/OFF, dimmer and colour temperature adjustment. Can control individual lamps or groups of lamps depending on setup. Can be paired with an unlimited amount of lamps. |

IR Adjustable Colour Temperature LED Lamp

Supply Volts: 220-240VAC



1201RGBW

| Code | Description | Lamp Wattage | Lumen | Lamp Colour | Size (mm) |
|-----------------|------------------------|--------------|-------|------------------|-----------|
| 1201RGBW | IR controlled LED lamp | 7W | 580lm | RGB + 2700-6500k | Ø68 x 119 |

Lamp Settings



WiFi Adjustable Colour Temperature LED Lamp

Supply Volts: 220-240VAC



1201RGBW-WF

| Code | Description | Lamp Wattage | Lumen | Lamp Colour | Size (mm) |
|-----------------------|---------------------------------------------------------|--------------|-------|------------------|-----------|
| 1201RGBW-WF | WiFi and IR controlled LED lamp. | 7W | 470lm | RGB + 2700-6500K | 68 x 119 |
| 1203RGBW-2S-WF | WiFi and IR controlled LED lamp with Bluetooth speaker. | 12W | 650lm | RGB + 2700-6500K | 73 x 132 |



1203RGBW-2S-WF

Lamps are grouped by Room and can be controlled as groups or individually

Easily selectable moods for different occasions

Manually selectable single colours and preset colour changing programs

Manually adjustable colour temperature and brightness

Programmable time delays and alarms

FLAME SIMULATION LED LAMP

Input Voltage: 85-265VAC | Dynamic Moving Flame | Static On & Flame Effect Controlled by Switch



| Code | Wattage | Lumens | Colour Temp | Base | Dimensions |
|----------------------|---------|-----------|-------------|------|-------------|
| LED-FLAME-E27 | 5W | 250-499lm | 1300K/1800K | E27 | Ø80 x 134mm |



LED DECORATIVE LAMPS

Amber LED Filament Lamps - Dimmable 2200K

Supply Volts: 230VAC



G45 A60 C35 ST64 G95 G125 T45

NEW

| Code | Wattage | Base | Filament Shape | Size (mm) | Colours |
|-------------|---------|-----------|----------------|------------|---------|
| BF-G45-L | 1W | E27 | Loop | Ø45 x 74 | WW |
| BF-A60-Q-* | 2W | E27 / B22 | Quad | Ø60 x 105 | WW |
| BF-C35-Q | 2W | E14 | Quad | Ø35 x 100 | WW |
| BF-ST64-S | 2W | E27 | Spiral | Ø64 x 145 | WW |
| BF-G95-S | 2W | E27 | Spiral | Ø95 x 115 | WW |
| BF-G125-S | 2W | E27 | Spiral | Ø125 x 170 | WW |
| BF-T45-S | 2W | E27 | Spiral | Ø45 x 110 | WW |
| AS-A60-ST-* | 2W | E27 / B22 | Long | Ø60 x 105 | WW |
| AS-C35-ST | 2W | E14 | Long | Ø35 x 100 | WW |
| AS-ST64-ST | 2W | E27 | Long | Ø64 x 145 | WW |
| AS-G95-ST | 2W | E27 | Long | Ø95 x 115 | WW |
| AS-G125-ST | 2W | E27 | Long | Ø125 x 170 | WW |
| AS-T45-ST | 2W | E27 | Long | Ø45 x 110 | WW |
| AS-T30-ST | 2W | E27 | Long | Ø30 x 295 | WW |

NEW



A60 C35 ST64 G95 G125 T45 T30

Clear LED Decorative Lamps - Scattered LED

Supply Volts: 230VAC



DN-ST64-WW DN-ST64-V DN-ST64-BL HB-ST64

| Code | Wattage | Base | Filament Shape | Size (mm) | Colours |
|-----------|---------|------|----------------|-----------|-----------------|
| DN-ST64-* | 3W | E27 | Scattered | Ø64 x 150 | WW / BL / V / S |

* Add colour to code: ○WW (Warm White) 2700K, ●BL (Blue), ●V (Violet), ●S (7 Colours)

3D Effect Lamps

Supply Volts: 230VAC



HB-G125 WS-G95-WW WS-G125-WW

| | | | | | |
|------------|----|-----|----------|------------|----|
| HB-A60-3D | 6W | E27 | Straight | Ø64 x 140 | WW |
| HB-ST64-3D | 6W | E27 | Straight | Ø64 x 140 | WW |
| HB-G125-3D | 6W | E27 | Straight | Ø125 x 176 | WW |

Twisted Wire

Supply Volts: 230VAC

| | | | | | |
|------------|------|-----|---------|------------|----|
| WS-G95-WW | 1.5W | E27 | Twisted | Ø95 x 138 | WW |
| WS-G125-WW | 1.5W | E27 | Twisted | Ø125 x 175 | WW |

Filament Text

Supply Volts: 230VAC

| | | | | | |
|----------------|----|-----|------|------------|----|
| LVE-G125-4W-WW | 4W | E27 | Love | Ø125 x 176 | WW |
|----------------|----|-----|------|------------|----|



LVE-G125 IR-A165 IR-BT150

Irregular Lamp Shape

Supply Volts: 230VAC

| | | | | | |
|----------------|----|-----|--------|------------|----|
| IR-A165-4W-WW | 4W | E27 | Spiral | Ø160 x 300 | WW |
| IR-BT150-6W-WW | 6W | E27 | Spiral | Ø150 x 225 | WW |

Shattered Glass Effect - 2700K | 360° Beam Angle

Supply Volts: 230VAC



G130-1 G130-2 G130-3 G130-4 G130-7 G130-15

| Code | Wattage | Base | Filament Shape | Size (mm) | Colours |
|------------|---------|------|----------------|------------|---------|
| G130-1-WW | 6W | E27 | Straight | Ø130 x 180 | WW |
| G130-2-WW | 6W | E27 | Straight | Ø130 x 180 | WW |
| G130-3-WW | 6W | E27 | Straight | Ø130 x 180 | WW |
| G130-4-WW | 6W | E27 | Straight | Ø130 x 180 | WW |
| G130-7-WW | 6W | E27 | Straight | Ø130 x 180 | WW |
| G130-15-WW | 6W | E27 | Straight | Ø130 x 180 | WW |

Ice Flower - 2700K | 360° Beam Angle

Supply Volts: 230VAC



G95-ICE-WH G95-ICE-Y G125-ICE-WH G125-ICE-Y

| Code | Wattage | Base | Filament Shape | Size (mm) | Colours |
|-------------|---------|------|----------------|------------|---------|
| G95-ICE-WH | 6W | E27 | Straight | Ø95 x 138 | WW |
| G95-ICE-Y | 6W | E27 | Straight | Ø95 x 138 | WW |
| G125-ICE-WH | 6W | E27 | Straight | Ø125 x 176 | WW |
| G125-ICE-Y | 6W | E27 | Straight | Ø125 x 176 | WW |

* Add base to code: E27 or B22

LED DECORATIVE LAMPS

Coloured G45 - 360° Beam Angle | Single Filament | 2 per Pack | Supply Volts: 230VAC

| Code | Wattage | Base | Filament Shape | Size (mm) | Colours |
|--------------|---------|------|----------------|-----------|---------|
| AG45-1W-R/2 | 1W | B22 | Straight | Ø45 x 74 | Red |
| AG45-1W-GN/2 | 1W | B22 | Straight | Ø45 x 74 | Green |
| AG45-1W-BL/2 | 1W | B22 | Straight | Ø45 x 74 | Blue |
| AG45-1W-Y/2 | 1W | B22 | Straight | Ø45 x 74 | Yellow |
| AG45-1W-P/2 | 1W | B22 | Straight | Ø45 x 74 | Purple |



AG45-1W-R AG45-1W-GN AG45-1W-BL AG45-1W-Y AG45-1W-P



G95-2W-R G95-2W-GN G95-2W-BL G95-2W-Y G95-2W-P

Coloured G95 - 360° Beam Angle | Single Filament | Supply Volts: 230VAC

| Code | Wattage | Base | Filament Shape | Size (mm) | Colours |
|-----------|---------|------|----------------|-----------|---------|
| G95-2W-R | 2W | E27 | Straight | Ø95 x 140 | Red |
| G95-2W-G | 2W | E27 | Straight | Ø95 x 140 | Green |
| G95-2W-BL | 2W | E27 | Straight | Ø95 x 140 | Blue |
| G95-2W-Y | 2W | E27 | Straight | Ø95 x 140 | Yellow |
| G95-2W-P | 2W | E27 | Straight | Ø95 x 140 | Purple |

NEW

SUPER FINE FILAMENT EFFECT

Twisted DNA Filament Effect Lamp - 1800K | Supply Volts: 230VAC

| Code | Wattage | Base | Filament Shape | Size (mm) | Colours |
|---------------|---------|------|----------------|------------|---------|
| RN-DNA-G125-C | 3.5W | E27 | DNA | Ø125 x 164 | WW |
| RN-DNA-G125-S | 3.5W | E27 | DNA | Ø125 x 164 | WW |
| RN-DNA-G125-A | 3.5W | E27 | DNA | Ø125 x 164 | WW |



RN-DNA-G125-C Clear Glass RN-DNA-G125-S Smokey Glass RN-DNA-G125-A Amber Glass

Graphic Filament Effect Lamp - 1800K | Supply Volts: 230VAC

| Code | Wattage | Base | Filament Shape | Size (mm) | Colours |
|-----------------|---------|------|----------------|------------|---------|
| RN-GRP-G125-WV | 6W | E27 | Straight | Ø125 x 172 | WW |
| RN-GRP-G125-DOT | 6W | E27 | Straight | Ø125 x 172 | WW |
| RN-GRP-G125-MET | 3.5W | E27 | Straight | Ø125 x 164 | WW |



RN-GRP-G125-WV RN-GRP-G125-DOT RN-GRP-G125-MET

Shaped Glass Filament Effect Lamp - 1800K | Supply Volts: 230VAC

| Code | Wattage | Base | Filament Shape | Size (mm) | Colours |
|-----------------|---------|------|----------------|------------|---------|
| RN-I-CG200 | 4W | E27 | Straight | Ø200 x 241 | WW |
| RN-I-HR-G130-A | 4W | E27 | Straight | Ø130 x 178 | WW |
| RN-I-VR-G130-A | 4W | E27 | Straight | Ø130 x 174 | WW |
| RN-I-FEC-G130-C | 4W | E27 | Straight | Ø125 x 174 | WW |



RN-I-CG200 Amber Glass RN-I-HR-G130-A Amber Glass RN-I-VR-G130-A Amber Glass RN-I-FEC-G130-C Clear Glass

Plain Glass Filament Lamp - 1800K | Supply Volts: 230VAC

| Code | Wattage | Base | Filament Shape | Size (mm) | Colours |
|--------------|---------|------|----------------|------------|---------|
| RN-I-T60-A | 4W | E27 | Straight | Ø60 x 300 | WW |
| RN-I-G95-A | 4W | E27 | Straight | Ø95 x 144 | WW |
| RN-I-G125-A | 4W | E27 | Straight | Ø125 x 164 | WW |
| RN-I-AP125-S | 4W | E27 | Straight | Ø125 x 163 | WW |



RN-I-T60-A Amber Glass RN-I-G95-A Amber Glass RN-I-G125-A Amber Glass RN-I-AP125-S Smokey Glass

CARBON FILAMENT



Carbon Filament Lamps - 110-240V | Dimmable

| Code | Power | Base | Filament Shape | Size (mm) Ø x H |
|--------------------------|-------|---------|----------------|--------------------|
| Globe Type | | | | |
| A21-25W-* | 25W | E27/B22 | Quadloop | 68 x 125 |
| A21-40W-* | 40W | | | |
| A21-60W-* | 60W | | | |
| Candle Flame Type | | | | |
| FC35-25W-E14 | 25W | E14 | Z-Style | 35 x 120 |
| FC35-40W-E14 | 40W | | | |
| Pear Shape Type | | | | |
| ST58-40W-* | 40W | E27/B22 | Squirrel Cage | 58 x 135 |
| ST58-60W-* | 60W | | | |
| Large Ball Type | | | | |
| G125-40W-* | 40W | E27/B22 | Squirrel Cage | 125 x 175 |
| G125-60W-* | 60W | | | |

*Add base to code: **E27** or **B22**

NEW

PYGMY - INCANDESCENT

| | Fridge | Oven 300°C | Oven 300°C | Oven 300°C | Oven 300°C |
|-------------|-------------|---------------|---------------|---------------|---------------|
| | | | | | |
| Code | FPL-15W-E14 | OPL-15W-E14 | OPL-25W-E14 | OPL-40W-E14 | OPL-40W-E27 |
| Wattage | 15W | 15W | 25W | 40W | 40W |
| Base | E14 | E14 | E14 | E14 | E27 |
| Lumens | 150lm | 150lm | 250lm | 400lm | 400lm |
| Size(mm) | Ø26 x 56 | Ø25 x 55 | Ø25 x 55 | Ø75 x 45 | Ø45 x 73 |
| Colour | 2700K | 2700K | 2700K | 2700K | 2700K |

STANDARD FILAMENT LAMPS



Halogen Classic A60 - 230VAC | Ø60 x 107

| Code E27 | Code B22 | Code E14 | Watts | Lumen |
|------------|------------|----------|-------|--------|
| A60-28-E27 | A60-28-B22 | - | 28W | 672lm |
| A60-72-E27 | A60-72-B22 | - | 72W | 1728lm |

Incandescent A60 - 230VAC or 110VAC

| | | | | |
|----------|---|---|-----|-------|
| E27-25-* | - | - | 25W | 350lm |
|----------|---|---|-----|-------|

*Add voltage to code: **230V** or **115V**

Incandescent Golf Ball Lamps - 230VAC | Ø45 x 77

| | | | | |
|----------|----------|---|-----|-------|
| E27-15-Y | B22-15-* | - | 15W | 210lm |
|----------|----------|---|-----|-------|

*Add colour to code: ● **R** (Red), ● **GN** (Green), ● **Y** (Yellow)

Halogen Flame Lamps - 230VAC

| | | | | |
|-------------|---|-------------|-----|--------|
| FLM-E27-28W | - | FLM-E14-28W | 28W | 672lm |
| FLM-E27-42W | - | FLM-E14-42W | 42W | 1008lm |

Incandescent Flicker Flame Lamps - 230VAC

| | | | | |
|---|---|------------|----|------|
| - | - | FFL-E14-3W | 3W | 42lm |
|---|---|------------|----|------|

ENERGY SAVING LAMPS & HOLDERS

Energy Saving Compact Fluorescent Lamps • 8000 hrs

| Code | Wattage | Base | Length | Base Code |
|------------------------------|---------|-------|--------|-----------|
| 2 Pin type Inline | | | | |
| PL-7-* | 7W | G23 | 137mm | BCF-G23 |
| PL-9-* | 9W | G23 | 167mm | BCF-G23 |
| PL-9-CW 110V | 9W | G23 | 167mm | BCF-G23 |
| PL-11-* | 11W | G23 | 237mm | BCF-G23 |
| PL-13-* | 13W | G23 | 188mm | BCF-G23 |
| 2 Pin Type Off Centre | | | | |
| PLC-13-* | 13W | G24d1 | 130mm | BCF-G24d1 |
| PLC-18-* | 18W | G24d2 | 152mm | BCF-G24d2 |
| PLC-26-* | 26W | G24d3 | 167mm | BCF-G24d3 |
| 4 Pin Type | | | | |
| PLCE-13-* | 13W | G24q1 | 132mm | BCF-G24q1 |
| PLCE-18-* | 18W | G24q2 | 144mm | BCF-G24q2 |
| PLCE-26-* | 26W | G24q3 | 165mm | BCF-G24q3 |
| PLCE-42-* | 42W | G24q4 | 168mm | BCF-G24q4 |

*Add to code: ○ **WW** (Warm White, 2700K), ○ **CW** (Cool White, 4000K)



PL-7-CW



PLC-26-CW



PLCE-13-CW



BCF-G23

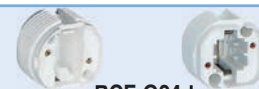

BCF-G24d



BCF-G24q

ENERGY SAVING LAMPS & HOLDERS

| Image | Code | Wattage | Base | Length | Base Code | Image |
|-----------------------------------------------------------------------------------------|---------------------|---------|-------|--------|-----------|-------|
| | PLE-7-* | 7W | 2G7 | 122mm | BCF-2G7 | |
| | PLE-9-* | 9W | 2G7 | 152mm | BCF-2G7 | |
| | PLE-11-* | 11W | 2G7 | 222mm | BCF-2G7 | |
| *Add to code: ○ WW (Warm White, 2700K), ○ CW (Cool White, 4000K) | | | | | | |
| | NB5025-18-* | 18W | 2G11 | 227mm | BCF-2G11 | |
| | NB5025-24-* | 24W | 2G11 | 322mm | BCF-2G11 | |
| | NB5025-36-* | 36W | 2G11 | 417mm | BCF-2G11 | |
| | NB5025-55-* | 55W | 2G11 | 542mm | BCF-2G11 | |
| *Add to code: ○ WW (Warm White, 2700K), ○ CW (Cool White, 4000K), ○ D (Daylight, 6500K) | | | | | | |
| | 2D-16-* (2 Pin) | 16W | GR8 | 139mm | BCF-GR8 | |
| | 2D-16-4P-CW (4 Pin) | 16W | GR10q | 139mm | BCF-GR10q | |
| | 2D-21-* (2 Pin) | 21W | GR8 | 139mm | BCF-GR8 | |
| | 2D-28-* (2 Pin) | 28W | GR8 | 202mm | BCF-GR8 | |
| | 2D-28-4P-* (4 Pin) | 28W | GR10q | 202mm | BCF-G10q | |
| *Add to code: ○ WW (Warm White, 2700K), ○ CW (Cool White, 4000K) | | | | | | |

FLUORESCENT LAMPS

| Image | T5 Lamps | | | | | | T8 Lamps | | | | | |
|------------------------------------------------------------|----------------------|--------------|--------|--------|--------|------------------------------|------------------------------------------------------------------------------------------------------------------------------------------------------|--------------|------|--------|--------|--------|
| | Code | Colour Temp. | Type | Length | Watts | Lumen | Code | Colour Temp. | Type | Length | Watts | Lumen |
| | FLT5-6-CW | 4000K | T5 | 225mm | 6W | 240lm | FLT8-10-CW | 4000K | T8 | 1FT | 10W | 650lm |
| | FLT5-8-CW | 4000K | T5 | 300mm | 8W | 380lm | FLT8-15-DL | 6500K | T8 | 450mm | 15W | 900lm |
| | FLT5-13-CW | 4000K | T5 | 517mm | 13W | 1010lm | FLT8-18-CW | 4000K | T8 | 2FT | 18W | 1100lm |
| | FLT5-14-CW | 4000K | T5 | 563mm | 14W | 1200lm | FLT8-18-DL | 6500K | T8 | 2FT | 18W | 1100lm |
| | FLT5-14-DL | 6500K | T5 | 563mm | 14W | 1200lm | FLT8-18-WW | 2700K | T8 | 2FT | 18W | 1100lm |
| | FLT5-21-CW | 4000K | T5 | 863mm | 21W | 1870lm | FLT8-30-CW | 4000K | T8 | 3FT | 30W | 2350lm |
| | FLT5-28-CW | 4000K | T5 | 1163mm | 28W | 2600lm | FLT8-36-* | - | T8 | 4FT | 36W | 3350lm |
| | FLT5-28-0-CW (Osram) | 4000K | T5 | 1163mm | 28W | 2600lm | FLT8-36-DL-PH (Phillips) | 6500K | T8 | 4FT | 36W | 3350lm |
| | FLT5-28-DL | 6500K | T5 | 1163mm | 28W | 2600lm | FLT8-58-* | - | T8 | 5FT | 58W | 5200lm |
| | FLT5-32-CW | 4000K | T5 | 1210mm | 32W | 3300lm | *Add colour temp. to code: SNW (Snow White - 12000K), WW (Warm White - 2700K), CW (Cool White - 4000K), DL (Daylight - 6500K), SW (Skywhite - 8000K) | | | | | |
| FLT5-35-CW | 4000K | T5 | 1449mm | 35W | 3135lm | T8 Coloured Lamps | | | | | | |
| FLT5-35-DL | 6500K | T5 | 1449mm | 35W | 3135lm | FLT8-36-* | Y | T8 | 4FT | 36W | 2800lm | |
| FLT5-49-CW | 4000K | T5 | 1449mm | 49W | 4000lm | FLT8-58-* | R, Y, G | T8 | 5FT | 58W | 4100lm | |
| FLT5-54-CW | 4000K | T5 | 1149mm | 54W | 4200lm | T8 Triphosphour Lamps | | | | | | |
| FLT5-54-CDL | 6500K | T5 | 1149mm | 54W | 4200lm | FLT8-18-WW-TRI | 2700K | T8 | 2FT | 18W | 1100lm | |
| FLT5-80-CW | 4000K | T5 | 1449mm | 80W | 7000lm | FLT8-36-WW-TRI | 2700K | T8 | 4FT | 36W | 2800lm | |
| FLT5-80-SW | 8000K | T5 | 1449mm | 80W | 6500lm | FLT8-58-WW-TRI | 2700K | T8 | 5FT | 58W | 4800lm | |
| Black Ultra Violet Lamps - 3000h life (Osram Lamps) | | | | | | | | | | | | |
| | Code | Base | Type | Length | Watts | Lumen | T8 Energy Saving Lamps | | | | | |
| | FLT5-6UV | G5 | T5 | 225mm | 6W | - | FLT8-ES23W-DL | 6500K | T8 | 5FT | 23W | 1900lm |
| | FLT5-8UV | G5 | T5 | 300mm | 8W | - | FLT8-ES37W-DL | 6500K | T8 | 5FT | 37W | 3215lm |
| | FLT8-18UV | G13 | T8 | 2FT | 18W | - | c/w special starter Only for use with magnetic switchgear | | | | | |
| FLT8-36UV | G13 | T8 | 4FT | 36W | - | T12 Lamps | | | | | | |
| Butcher Lamps – (Osram Lamps) | | | | | | | | | | | | |
| L30W/76 | G13 | T8 | 3FT | 30W | 1300lm | FLT12-75-CW | | | | | | |
| L36W/76 | G13 | T8 | 4FT | 36W | 1800lm | 4000K T12 8FT 75W 6600lm | | | | | | |
| L58W/76 | G13 | T8 | 5FT | 58W | 2850lm | | | | | | | |

Fluorescent Colour/ Lamp Protection - The coloured "Tubos" are a practical and economical solution for transforming a normal fluorescent lamp into a coloured one. AC/DC Tubos will give you protection, economy, UV-ray filters and coloured lamps. Suited for the Food & Beverage industry

| Code | Exterior Ø | Interior Ø | Wattage | Length | *Add Colour to Code: |
|--------------|------------|------------|---------|--------|------------------------------------|
| AKO-TUBO18-* | 28.7mm | 26mm | 18W | 590mm | T (Transparent), BL, G, R, A |
| AKO-TUBO36-* | 28.7mm | 26mm | 36W | 1200mm | T (Transparent), BL, G, R, A, O |
| AKO-TUBO58-* | 28.7mm | 26mm | 58W | 1500mm | T (Transparent), BL, G, R, Y, A, O |
| AKO-TUBO28-T | 18.7mm | 16mm | 28W | 1149mm | T (Transparent) |
| AKO-TUBO35-T | 18.7mm | 16mm | 35W | 1449mm | T (Transparent) |

T8 to T5 CONVERSION

Convert your existing T8 Light Fittings to Energy Saving T5

- CW - 4000K
- DL - 6000K

without reflector

with reflector



1. Wiring diagram for retrofit into fluorescent fitting with electronic ballast

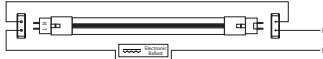

2. When tube is replaced in a standard fluorescent fitting with magnetic ballast

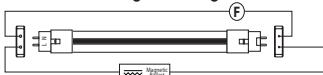

EL-FL fuse link

T8-T5 Conversion - No Reflector. (Supplied with lamp) PF:0.9

| Code | To Fit T8 | T5 Power | Size | Replacement Lamp | Colours |
|-----------------|-----------|----------|------------------|------------------|---------|
| EL-T8/T5-14W-DL | 2ft-18W | 14W | 588 x 24 x 35mm | FLT5-14W | DL |
| EL-T8/T5-21W-CW | 3ft-30W | 21W | 892 x 24 x 35mm | FLT5-21W | CW |
| EL-T8/T5-28W-* | 4ft-36W | 28W | 1197 x 24 x 35mm | FLT5-28W | CW / DL |
| EL-T8/T5-35W-* | 5ft-58W | 35W | 1498 x 24 x 35mm | FLT5-35W | CW / DL |

T8-T5 Conversion - With Reflector. (Supplied with lamp) PF:0.9

| Code | To Fit T8 | T5 Power | Size | Replacement Lamp | Colours |
|------------------|-----------|----------|------------------|------------------|---------|
| ELR-T8/T5-14W-CW | 2ft-18W | 14W | 588 x 45 x 35mm | FLT5-14W | CW |
| ELR-T8/T5-21W-CW | 3ft-30W | 21W | 892 x 45 x 35mm | FLT5-21W | CW |
| ELR-T8/T5-28W-CW | 4ft-36W | 28W | 1197 x 45 x 35mm | FLT5-28W | CW |
| ELR-T8/T5-35W-* | 5ft-58W | 35W | 1498 x 45 x 35mm | FLT5-35W | CW / DL |

Accessories

| Code | Description |
|-------|-------------------------------------------------------|
| EL-FL | Fuse link to replace starter in switch start fittings |

For retrofit into switch start fittings Power Factor capacitor should be removed and fuse link used instead of starter. For retrofit into electronic fittings rewiring is required. Please contact technical call centre for more information and wiring diagrams.

INFRARED PAR38

Mainly used in chicken farming.



Infrared Heat Lamp - 230VAC

| Code | PAR38-IR-175W |
|-----------|---------------|
| Power | 175W |
| Lamp Base | E27 |
| Lamp Life | 5000h |



Heat Lamp Fitting

| Code | HLF-01 |
|----------|---------------|
| Material | Bakelite |
| Size | Ø 145 x 180mm |

BLACK LIGHTS (UV LIGHTS)



UV2U

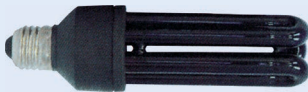

UV3U



UVPL

For UV LED Floodlight see page 28

Energy Saving Black Lights - E27

| Code | Wattage | Size (mm) |
|---------|---------|------------|
| UV2U-11 | 11W | 165 x Ø 45 |
| UV3U-15 | 15W | 140 x Ø 50 |
| UV3U-20 | 20W | 155 x Ø 50 |
| UV3U-25 | 25W | 170 x Ø 50 |

PL Lamps

| Code | Wattage | Base |
|----------|---------|-------|
| UVPL-9 | 9W | G23 |
| UVPL-13 | 13W | G23 |
| UVPLC-13 | 13W | G24d1 |
| UVPLC-18 | 18W | G24d2 |
| UVPLC-26 | 26W | G24d3 |

HIGH POWER CFL LAMPS



ESL42



F17

| Watts | Lumen | D Type Code | Length | F Type Code | Length |
|--------|---------|-----------------|--------|---------------|--------|
| 30W | 1530lm | - | - | F17-LH30-E27 | 168mm |
| 40/45W | 2040lm | - | - | F17-LH45-E27 | 220mm |
| 50/55W | 3000lm | - | - | F17-LH55-E40 | 260mm |
| 65W | 3315lm | ESL42-65-*D | 258mm | F17-LH65-E40 | 285mm |
| 80W | 4335lm | ESL42-80-E40-D | 293mm | - | - |
| 85W | 4335lm | - | - | F17-LH85-E40 | 280mm |
| 120W | 4620lm | - | - | F17-LH120-E40 | 305mm |
| 150W | 5500lm | - | - | F17-LH150-E40 | 305mm |
| 200W | 9600lm | ESL42-200-E40-D | 360mm | - | - |
| 250W | 14850lm | ESL42-250-E40-D | 400mm | - | - |

*Add to code: E27, E40

ENERGY SAVING LAMPS - TUBULAR

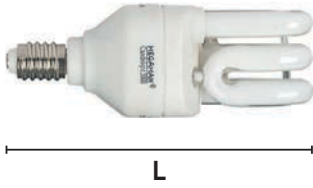

Tubular - 15000 hours lifetime 220-240VAC

| Code Warm White | L(mm) | Watts | Base | Colour | Code Cool White | Watts | Base | Colour |
|-----------------|-------|-------|------|--------|-----------------|-------|------|--------|
| SU207-E14-WW | 103 | 7W | E14 | 2700K | SU207-E14-CW | 7W | E14 | 4000K |

ENERGY SAVING LAMPS



Globe Compact Fluorescent Lamp - Replacement for Standard Incandescent Globe 230VAC

| | | |
|-----|---|------|
| CFL | → | GLS |
| 9W | → | 45W |
| 11W | → | 60W |
| 15W | → | 75W |
| 20W | → | 100W |

| Code E27 | Code B22 | Watts | Length | Lumen |
|------------------|-----------------|-------|--------|--------|
| ES-A60-E27-11-* | ES-A60-B22-11-* | 11W | 110mm | 500lm |
| ES-A60-E27-15-* | ES-A60-B22-15-* | 15W | 120mm | 800lm |
| ES-A60-E27-20-WW | ES-A60-B22-20-* | 20W | 130mm | 1000lm |

*Add colour to code: ○ WW (Warm White), ○ CW (Cool White)

Candle Light Compact Fluorescent Lamps - 230VAC



| Code E14 | Code E27 | Code B22 | Watts | Length | Lumen |
|----------------|----------------|-----------------|-------|--------|-------|
| - | ES-CDL-E27-5-* | - | 5W | 98mm | 200lm |
| - | ES-CDL-E27-7-* | ES-CDL-B22-7-* | 7W | 98mm | 280lm |
| ES-CDL-E14-9-* | ES-CDL-E27-9-* | ES-CDL-B22-9-CW | 9W | 108mm | 380lm |
| - | - | - | 5W | 125mm | 180lm |
| FE38-7-E14-WW | - | - | 7W | 125mm | 280lm |
| FE38-9-E14-WW | - | - | 9W | 135mm | 380lm |
| FE40-5-E14-G | - | - | 5W | 125mm | 180lm |
| FE40-7-E14-G | - | - | 7W | 127mm | 300lm |

*Add colour to code: ○ WW (Warm White), ○ CW (Cool White)

Large Size Candle Light Compact Fluorescent Lamps - 230VAC



| | | | | | |
|---------------|----------------|----------------|-----|-------|-------|
| - | FE36-5-E27-WW | - | 5W | 149mm | 180lm |
| FE36-7-E14-WW | - | FE36-7-B22-WW | 7W | 149mm | 280lm |
| FE36-9-E14-WW | FE36-9-E27-WW | - | 9W | 169mm | 380lm |
| - | FE36-11-E27-WW | FE36-11-B22-WW | 11W | 169mm | 500lm |

Golf Ball Compact Fluorescent Lamp - 230VAC



| | | | | | |
|-------------|-------------|-------------|----|------|---|
| GA607-E14-* | GA607-E27-* | GA607-B22-* | 7W | 89mm | - |
|-------------|-------------|-------------|----|------|---|

*Add colour to code: ○ WW (Warm White), ○ CW (Cool White), ● R (Red), ● GN (Green), ● Y (Yellow)

Spiral Compact Fluorescent Lamp - 230VAC



| | | | | | |
|---|---------------|---------------|-----|-------|-------|
| - | FE35-15-E27-* | FE35-15-B22-* | 15W | 128mm | 701lm |
|---|---------------|---------------|-----|-------|-------|

*Add colour to code: ○ WW (Warm White), ● O (Orange)

Mosquito Repelling Lamp - 230VAC



| Code | Description | Length |
|----------------|-------------|--------|
| RDZ-15-25B-MOS | 15W E27 | 135mm |

Dimmable range 15 000 hours lifetime 220-240VAC

Dimmable to 4 preset levels

| Code | Watts | Base | Colour Temp. | Length |
|--------|-------|------|--------------|--------|
| GK715S | 15W | E27 | 2700K | 128mm |

4-step dimming (100%-66%-33%-5%)

4-Step Dimming - Every Dimmable Compact Fluorescent switching OFF/ON will activate the dimming program of the lamp. The brightness of the lamp can be adjusted from 100% to 66%, 33% or 5% with consecutive switching OFF/ON action within 1 second.

ENERGY SAVING LAMPS



Energy Saving Compact Fluorescent Lamps 230VAC - Warm white - 2700K; Cool white - 4000K

| Code E27 | Code B22 | Watts | Length | Lumen |
|--------------------------------|-----------------|-------|--------|--------|
| FE1-7-E27-WW | - | 7W | 135mm | 238lm |
| FE1-9-E27-WW | FE1-9-B22-WW | 9W | 136mm | 367lm |
| - | FE1-11-B22-WW | 11W | 146mm | 449lm |
| For E14 replace B22 with E14 | | | | |
| FE27-20-E27-WW | - | 20W | 155mm | 935lm |
| FE27-20-E27-WW/10 (PACK OF 10) | - | 20W | 155mm | 935lm |
| - | FE27-25-B22-WW | 25W | 172mm | 1360lm |
| FE35-11-E27-WW | FE35-11-B22-WW | 11W | 122mm | 449lm |
| FE35-20-E27-WW | FE35-20-B22-WW | 20W | 141mm | 935lm |
| - | FE35-26-B22-WW | 26W | 165mm | 1326lm |
| - | FE10-11-B22-WW | 11W | Ø90mm | 443lm |
| - | FE10-16-B22-WW | 16W | Ø100mm | 695lm |
| - | FE10-18-B22-WW | 18W | Ø100mm | 833lm |
| - | FE10-24-B22-WW | 24W | Ø120mm | 1105lm |
| FE29-9-E27-* | FE29-9-B22-* | 9W | 152mm | 360lm |
| FE29-11-E27-* | FE29-11-B22-CW | 11W | 152mm | 443lm |
| FE50-15-E27-* | FE50-15-B22-* | 15W | 164mm | 695lm |
| - | FE32-22-B22-WW | 22W | Ø210mm | 1900lm |
| - | FE16-20-B22-WW | 20W | 170mm | 895lm |
| - | FE18-S11-B22-WW | 11W | 109mm | 550lm |
| - | FE18-S20-B22-* | 20W | 144mm | 1080lm |

*With daylight sensor. Supply Voltage 230VAC



Reflective Type

| Code E27 | Code B22 | Watts | Type | Lumen |
|----------------|----------------|-------|-------|--------|
| FE66-11-E27-WW | FE66-11-B22-WW | 11W | R80 | 449lm |
| ERF-15-E27-CW | ERF-15-B22-CW | 15W | R80 | 701lm |
| ERB-20-E27-CW | - | 20W | PAR38 | 935lm |
| ERB-25-E27-CW | - | 25W | PAR38 | 1265lm |

PAR56

| Code | Lamp Base | Watts | Type | Lumen |
|------------|-----------|-------|-------|-------|
| LUXPAR56-* | GU10 | 23W | PAR56 | 980lm |

*Add colour to code: ○ CW (Cool White), ○ WW (Warm White)



GU10 CFL 12000hrs - Not Dimmable 220-240VAC

| Watts | Warm White 2700K | Cool White 4000K | Daylight 6500K | Lens | Length |
|-------|------------------|------------------|----------------|----------|--------|
| 7W | SP2007-WW | SP2007-CW | - | Diffused | 68mm |
| 9W | SP2009-WW | SP2009-CW | SP2009-DL | Diffused | 78mm |
| 11W | SP20011-WW | SP20011-CW | SP20011-DL | Diffused | 84mm |
| 13W | SP20013-WW | SP20013-CW | SP20013-DL | Diffused | 86mm |



R50/E14 CFL 15000hrs

| Watts | Warm White 2700K | Cool White 4000K | Lens | Length |
|-------|------------------|------------------|-------|--------|
| 7W | BR0107-WW | BR0107-CW | Clear | - |

Accessory

| Code | Description |
|-------|-------------------------------------|
| MM166 | Reflector for BR0107 Ø80 x 54H (mm) |

7W
9W
11W
13W

12000h

30W
40W
50W
60W

2000h

MR16/GU5.3 12000hrs - 220-240VAC

| Watts | Warm White 2700K | Cool White 4000K |
|-------|------------------|------------------|
| 7W | LUX240-7-WW | LUX240-7-CW |
| 9W | LUX240-9-WW | LUX240-9-CW |
| 11W | LUX240-11-WW | LUX240-11-CW |

MR16/GU5.3 8000hrs - 12VAC/DC

| Watts | Warm White 2700K | Cool White 4000K |
|-------|------------------|------------------|
| 7W | KS-MR16-7-WW | KS-MR16-7-CW |
| 9W | KS-MR16-9-WW | KS-MR16-9-CW |
| 11W | KS-MR16-11-WW | KS-MR16-11-CW |

Cat's Eye Glo-in-the-dark Lamps

| Code | GSU111-IAG |
|-------|------------|
| Watts | 11W |
| Base | E27 |

Lamp will glow in the dark for approximately 20 min after it has been switched off

DC ENERGY SAVING LAMPS



DC Lamps 8000 Hour Life

| Code E27 | Code B22 | Watts | Lumen | Length (H) |
|-----------------|----------------|-------|-------|------------|
| FE1-7-E27** | FE1-7-B22** | 7W | 238lm | 124mm |
| FE1-9-E27** | FE1-9-B22** | 9W | 367lm | 136mm |
| FE1-11-E27** | FE1-11-B22** | 11W | 449lm | 146mm |
| FE27-15-E27-WW* | FE27-15-B22** | 15W | 701lm | 139mm |
| FE27-20-E27** | FE27-20-B22** | 20W | 935lm | 164mm |
| - | FE36-5-B22-W* | 5W | 180lm | 108mm |
| - | FE36-7-B22-W* | 7W | 270lm | 108mm |
| - | FE36-9-B22-W* | 9W | 400lm | 117mm |
| - | FE36-11-B22-W* | 11W | 500lm | 136mm |

*Supply Voltage: 12VDC, 24VDC | *Add "-CW" for Cool White or "-WW" for Warm White

DC Lamps 15000 Hour Life

| | | | | |
|-----------------|---|----|-------|-------|
| CF1-9-E27-12VDC | - | 9W | 367lm | 140mm |
|-----------------|---|----|-------|-------|

ENERGY SAVING LAMPS & FITTINGS



Classic – 15000 hours lifetime 220-240VAC

| Code Warm White | L (mm) | Watts | Base | Colour | Code Cool White | Watts | Base | Colour |
|-----------------|--------|-------|------|--------|-----------------|-------|------|--------|
| - | - | - | - | - | GSU109-E27-CW | 9W | E27 | 4000K |
| GSU520-E27-WW | 140 | 20W | E27 | 2700K | GSU520-E27-CW | 20W | E27 | 4000K |
| - | - | - | - | - | GSU109-B22-CW | 9W | B22 | 4000K |
| GSU111-B22-WW | 113 | 11W | B22 | 2700K | GSU111-B22-CW | 11W | B22 | 4000K |
| GSU515-B22-WW | 116 | 15W | B22 | 2700K | GSU515-B22-CW | 15W | B22 | 4000K |

PAR's

- CW (Cool White),
- WW (Warm White)
- W (Warm White),
- GN (Green)



AR111 CFL Aluminium Reflector - Replaced AR111 Halogen Lamps 12000hrs | Supply Voltage 220-240VAC



| Code | BR01111-* | BR0620-* | Warm White 2700K | Cool White 4000K | Watts | Base | Type | Replaces Halogen |
|-------|-----------|-----------|------------------|------------------|-------|------|--------------|------------------|
| Size | E27/R63 | E27/PAR38 | LUXES111-WW | LUXES111-CW | 11W | GU10 | Spot (60°) | 75W |
| Watts | 11W | 20W | EF-AR111-WW | EF-AR111-CW | 20W | GU10 | Flood (105°) | 50W |

*Add colour to code: **WW / CW** **W / GN**

G9 Energy Saving Lamps 10 000 hours

Supply Voltage 220-240VAC

| Code | Watts | Base | Lumen | Length |
|----------|-------|------|-------|--------|
| S-AE-7-* | 7W | G9 | 445 | 69mm |
| S-AE-9-* | 9W | G9 | 585 | 75mm |

* Add 'CW' for Cool White or 'WW' for Warm White
Perfect replacement for hot G9 lamps
Diameter of lamp: 37mm
Produces less heat and consumes less energy



Mini-twist Energy Saver 9W



| | |
|--------|---------------|
| Code | MHS9W-GU10-WW |
| Watts | 9W |
| Base | GU10 |
| Length | 90mm |

Self Ballasted Plug-in Lamp 10 000 hours 220-240VAC

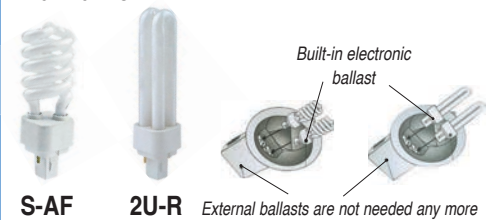

| Code | Watts | Base | Lumen | Length |
|------------|-------|--------|-------|--------|
| S-AF-10-* | 10W | G24d-1 | 530 | 105mm |
| S-AF-13-* | 13W | G24d-1 | 700 | 112mm |
| S-AF-18-* | 18W | G24d-2 | 950 | 123mm |
| 2U-R-10-* | 10W | G24d-1 | 500 | 127mm |
| 2U-R-13-* | 13W | G24d-1 | 650 | 137mm |
| 2U-R-18-* | 18W | G24d-2 | 900 | 147mm |
| 3U-R-26-WW | 26W | G24d-3 | 1300 | 167mm |

* Add 'CW' for Cool White or 'WW' for Warm White

DOUBLE ENDED HALOGEN LINEAR LAMPS

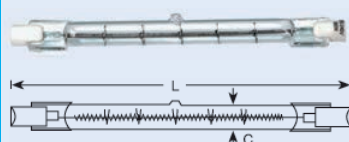

Expected lamp life 2000hrs

| Code | Watts | Lumens | Base | Length | Code | Watts | Lumens | Base | Length |
|------------|-------|--------|------|--------|-----------|-------|---------|------|--------|
| HD-150-78 | 150W | 2100lm | R7s | 78mm | HD-500 | 500W | 9500lm | R7s | 118mm |
| HD-150-118 | 150W | 2100lm | R7s | 118mm | HD-1000/2 | 1000W | 21000lm | R7s | 189mm |
| | | | | | HD-1500 | 1500W | 33000lm | R7s | 254mm |

HALOGEN CAPSULE LAMPS



Halogen Lamps - Colour Temp: 2900K | Some supplied with 2 per pack as shown in code /2

| Halogen Code | Watts | Voltage | Base Type | Luminous Intensity (lm) | Size L x Ø (mm) |
|--------------|-------|----------|-----------|-------------------------|-----------------|
| JCD-50/2 | 50W | 220-240V | G6.35 | 600 | 45 x 13 |
| JCD-100/2 | 100W | 220-240V | G6.35 | 1200 | 54 x 13 |
| JCD-150 | 150W | 220-240V | G6.35 | 2100 | 54 x 13 |
| JD-100 | 100W | 220-240V | BA15d | 1150 | 75 x 14 |



Halogen Flood Lamps - Replacement for Incandescent Reflector Lamps | Beam Angle 30°

| Code | Watts | Voltage | Base | Luminous Intensity (lm) | Size L x Ø (mm) |
|---------|-------|----------|------|-------------------------|-----------------|
| PAR16FL | 50W | 220-240V | E27 | 250 | 75 x 51 |
| PAR20FL | 50W | 220-240V | E27 | 350 | 80 x 64.5 |

INCANDESCENT LAMPS



Incandescent Lamps

| Type | E14 | Watts | BA15D | Watts | BA15D | Watts | E14 | Watts | BA15D | Watts |
|------------|---------|-------|---------|-------|---------|-------|---------|-------|---------|-------|
| Size | 16 x 45 | | 16 x 45 | | 35 x 56 | | 45 x 75 | | 16 x 54 | |
| Volts: *12 | ACL1* | 5 | ACL31* | 5 | - | 45 | - | - | - | 7 |
| *24 | ACL1* | 5 | ACL31* | 5 | ACL42* | 45 | - | - | ACL61* | 7 |
| *110/130 | ACL1* | 7/10 | ACL31* | 10 | - | - | ACL51* | 40 | ACL61* | 7 |
| *230/240 | ACL1*/2 | 7/10 | ACL31* | 10 | - | - | ACL51* | 40 | ACL61* | 7 |



PAR56 - For swimming pools | 12V

| Code | Watts | Base |
|-------|-------|---------|
| ACL81 | 120W | Fast on |

PAR46 - For swimming pools | 12V

| Code | Watts | Base |
|--------|-------|---------|
| ACLP46 | 100W | Fast on |

PAR38 - 230/240V

| Code | Watts | Base |
|-------|-------|------|
| ACL91 | 75W | E27 |



Frosted Reflective - 230/240V

| Code | R | Watts | Base |
|-------|----|-------|------|
| ACL72 | 50 | 40W | E27 |
| ACL74 | 80 | 75W | E27 |
| ACL75 | 80 | 100W | E27 |

DICHROIC LAMPS



Xenon
Extends
Life
8000hrs

Halogen Lamp 2000-3000hrs Colour Temp K = 2900 *Xenon Lamp 12V 8000hrs • Xenon Lamp (GU) 230V 5000hrs

| Halogen Code | Watts | Voltage | Base Type | Beam Angle | Luminous Intensity (lm) | *Xenon Code |
|------------------|-------|---------|-----------|------------|-------------------------|---------------|
| Open Type | | | | | | |
| MR11-20/2 | 20W | 12V | GU4/GZ4 | 30° | 1100 | - |
| MR16-20/2 | 20W | 12V | GU5.3 | 36° | 500 | - |
| - | 35W | 12V | GU5.3 | 36° | 850 | XMR16-35 *12V |
| - | 50W | 24V | GU5.3 | 36° | 1550 | *XMR16-50 |
| GU10-35* | 35W | 230V | GU10 | 30° | 600 | XGU10-35 |
| GU10-50 | 50W | 230V | GU10 | 30° | 1000 | XGU10-50 |

*Add /2 for pack of 2

Closed Type *XMR16 Xenon Lamp not available in 230V and 24V. Only 12V

| Code | Watts | Voltage | Base Type | Beam Angle | Luminous Intensity (lm) | Xenon Code |
|-----------|-------|----------|-----------|------------|-------------------------|------------|
| MR11S-20 | 20W | 12V | GU4 | 30° | 1100 | - |
| MR16S-20* | 20W | 12V | GU5.3 | 36° | 500 | - |
| MR16S-35* | 35W | 12V | GU5.3 | 36° | 850 | - |
| MR16S-50* | 50W | 24V/230V | GU5.3 | 36° | 1550 | - |
| GU10S-35* | 35W | 230V | GU10 | 30° | 600 | XGU10S-35 |

*Add /2 for pack of 2

Closed Type Coloured Lens

| Code | Watts | Voltage | Base Type | Beam Angle | Luminous Intensity (lm) | Xenon Code |
|-----------|-------|---------|-----------|------------|-------------------------|------------|
| MR16S-20* | 20W | 12V | GU5.3 | 24° | 950 | - |
| MR16S-35* | 35W | 12V | GU5.3 | 24° | 1800 | - |
| MR16S-50* | 50W | 12V | GU5.3 | 24° | 3000 | - |

*Add Colour of Lens to Code: ● R (Red), ● G (Green), ● Y (Yellow), ● B (Blue) or ● P (Purple)

METAL HALIDE LAMPS

| | <u>Double Ended</u> | | <u>G12 Single Ended</u> | | | <u>Tubular</u> | |
|--------------|------------------------|-------------|-------------------------|-----------|------------|------------------------|------------|
| | | | | | | | |
| Code | HQI-TS-70W | HQI-TS-150W | HCI-T-35W | HCI-T-70W | HCI-T-150W | HQI-T-250W | HQI-T-400W |
| Power | 70W | 150W | 35W | 70W | 150W | 250W | 400W |
| Current | 1A | 1.80A | 0.5A | 1.0A | 1.2A | 3.0A | 4.1A |
| Finish | Clear | Clear | Clear | Clear | Clear | Clear | Clear |
| Lamp base | RX7s | RX7s | G12 | G12 | G12 | E40 | E40 |
| Lumen | 5800lm | 13000lm | 3400lm | 6800lm | 10500lm | 20000lm | 36000lm |
| Colour Temp. | Natural Daylight 4200K | | Natural Daylight 4200K | | | Natural Daylight 4200K | |

| | <u>Elliptical</u> | | | <u>1000W</u> | | <u>Double Ended</u> | |
|--------------|-------------------|------------|------------|--------------|-------------|---------------------|-------------|
| | | | | | | | |
| Code | HQI-E-150W | HQI-E-250W | HQI-E-400W | HQI-T-1000W | HQI-T-2000W | HQI-TS-1000 | HQI-TS-2000 |
| Power | 150W | 250W | 400W | 1000W | 2000W | 1000W | 2000W |
| Current | 1.8A | 2.1A | 3.7A | 9.7A | 10.3A | 8.6A | 11.3A |
| Finish | Coated | Coated | Coated | Clear | Clear | Clear | Clear |
| Lamp base | E27 | E40 | E40 | E40 | E40 | X528 | X528 |
| Lumen | 12100lm | 21500lm | 40000lm | 90000lm | 220000lm | 85000lm | 230000lm |
| Colour Temp. | 4200K | 4200K | 4200K | 4400K | 4200K | 7250K | 6100K |

HIGH PRESSURE SODIUM LAMPS

| <u>Tubular</u> | | | | | |
|----------------|-----------|------------|------------|------------|-------------|
| Code | NAV-T-70W | NAV-T-150W | NAV-T-250W | NAV-T-400W | NAV-T-1000W |
| Power | 70W | 150W | 250W | 400W | 1000W |
| Current | 1A | 1.80A | 3A | 4.50A | 10.6A |
| Finish | Clear | Clear | Clear | Clear | Clear |
| Lamp base | E27 | E40 | E40 | E40 | E40 |
| Lumen | 6600lm | 17500lm | 33200lm | 56500lm | 130000lm |

| <u>Elliptical</u> | | | | | <u>Internal Ignitor</u> |
|-------------------|-----------|------------|------------|------------|-----------------------------|
| Code | NAV-E-70W | NAV-E-150W | NAV-E-250W | NAV-E-400W | NAV-E-70W-I |
| Power | 70W | 150W | 250W | 400W | 70W |
| Current | 1A | 1.80A | 3A | 4.40A | 0.98A |
| Finish | Coated | Coated | Coated | Coated | Coated |
| Lamp base | E27 | E40 | E40 | E40 | E27 |
| Lumen | 6300lm | 17000lm | 31600lm | 56500lm | 5800lm |

Lamps

LIGHTING

MERCURY VAPOUR LAMPS

| Elliptical | | | | |
|-------------|----------------|-----------------|-----------------|-----------------|
| Code | HQL-80W | HQL-125W | HQL-250W | HQL-400W |
| Power | 80W | 125W | 250W | 400W |
| Current | 0.80A | 1.2A | 2.1A | 3.2A |
| Finish | Coated | Coated | Coated | Coated |
| Lamp base | E27 | E27 | E40 | E40 |
| Lumen | 4000lm | 6800lm | 14000lm | 24000lm |

MERCURY BLENDED LAMPS

| Elliptical | | | |
|-------------|----------------|----------------|----------------|
| Code | HWL-160 | HWL-250 | HWL-500 |
| Power | 160W | 250W | 500W |
| Current | 0.80A | 1.20A | 2.40A |
| Finish | Coated | Coated | Coated |
| Lamp base | E27 | E40 | E40 |
| Lumen | 3100lm | 5600lm | 14000lm |

HID LAMPS - ACDC

| Watts | Metal Halide (MH) Code | | | | High Pressure Sodium (HPS) Code | | |
|-------|------------------------|--------|-------------|--------------|---------------------------------|-----------------------------------|-------------|
| | G12 | Rx7s | Tubular | Elliptical | ST (Rx7s) | Tubular | Elliptical |
| 50W | G12-50-230VAC | - | - | - | - | - | - |
| 70W | G12-70 230VAC | MD-70 | - | MTE-70-E27 | ST-70 | SD-70-E27 SD-70I-E27 [†] | - |
| 100W | - | - | - | MTE-100-E27 | - | SD-100-* | - |
| 150W | G12-150 230VAC | MD-150 | - | MTE-150-E27 | ST-150 | SD-150-E27 | SE-150-E40 |
| 250W | - | - | MT-250-E40 | MTE-250-E40 | - | SD-250-E40 | SE-250-E40 |
| 400W | - | - | MT-400-E40 | MTE-400-E40 | - | SD-400-E40 | SE-400-E40 |
| 1000W | - | - | MT-1000-E40 | MTE-1000-E40 | - | SD-1000-E40 | SE-1000-E40 |

*Add base to code: E27 or E40
[†]High pressure sodium with internal igniter

| Colour | G12 | Rx7s | Tubular | Elliptical | ST (Rx7s) | Tubular | Elliptical |
|--------|-----|----------|------------|------------|-----------|---------|------------|
| 150W | - | MD-150-* | - | - | - | - | - |
| 400W | - | - | JLZ400W-BL | - | - | - | - |

* Add colour to code: ● BL (Blue), ● GN (Green)

Mercury Vapour

| | | | | |
|--|---------------|------|----------|-----|
| | QE-80 | 80W | 3240lm | E27 |
| | QE-125 | 125W | 5512.5lm | E27 |
| | QE-250 | 250W | 11025lm | E40 |
| | QE-400 | 400W | 21000lm | E40 |

Mercury Vapour Blended

| | | | | |
|--|---------------|------|---------|-----|
| | QB-160 | 160W | 3100lm | E27 |
| | QB-250 | 250W | 5600lm | E40 |
| | QB-500 | 500W | 14000lm | E40 |

MD-(HQI-TS); MT-(HQI-T); MTE-(HQI); SD-(NAV-TS); SE-(NAVE); QE-(HQL); QB-(Mercury Vapour blended lamps)
 Expected lamp life 5000hrs; Lamps to be used with relevant control gear.

LED FLOODLIGHTS

IDEAL FOR COASTAL REGIONS

2 Year Warranty



LED Plastic Floodlights - IP65 | Supply Voltage: 220-240VAC | **Stainless Steel Bracket**
| Colour Temp: 5500K | Plastic / Stainless Steel | SMD Chipset | Also Available in DC

| Code | Wattage | Lumens | Size (mm) |
|----------------|---------|--------|----------------|
| COS-FL10W-CW* | 10W | 900lm | 128 x 112 x 31 |
| COS-FL20W-CW* | 20W | 1800lm | 170 x 150 x 40 |
| COS-FL30W-CW* | 30W | 2250lm | 230 x 190 x 40 |
| COS-FL50W-CW* | 50W | 4500lm | 300 x 245 x 40 |
| COS-FL100W-CW* | 100W | 8000lm | 390 x 290 x 36 |

*Add Voltage to code: /12VDC, /24VDC

2 Year Warranty



Optional

LED Economical Floodlights - IP65 | Supply Voltage: 220-240VAC | Beam Angle: 120° | With 3 x MOV's | SMD Chipsets

| Code | Code With Day/Night Sensor | Wattage | Lumens | Size (mm) |
|------------|----------------------------|---------|---------|----------------|
| FL-10W-* | DNFL-10W-CW | 10W | 800lm | 95 x 85 x 25 |
| FL-20W-* | DNFL-20W-CW | 20W | 1600lm | 120 x 100 x 30 |
| FL-30W-* | DNFL-30W-CW | 30W | 2400lm | 150 x 120 x 30 |
| FL-50W-* | DNFL-50W-CW | 50W | 4000lm | 200 x 150 x 30 |
| FL-100W-* | DNFL-100W-CW | 100W | 8000lm | 250 x 180 x 30 |
| FL-150W-CW | DNFL-150W-CW | 150W | 12000lm | 270 x 210 x 34 |
| FL-200W-CW | DNFL-200W-CW | 200W | 16000lm | 250 x 300 x 40 |

*Add colour to code: ○ WW (Warm White) 3000K, ○ CW (Cool White) 5500-6000K

NEW
NEW
NEW

| | | | | |
|------------|---|------|---------|----------------|
| FL-400W-* | - | 400W | 32000lm | 490 x 370 x 50 |
| FL-500W-DL | - | 500W | 42500lm | 695 x 320 x 40 |

*Add colour to code: ○ CW (Cool White) 4200K, ○ DL (Daylight) 6000K

3 Year Warranty



LED General Floodlights - IP65 | Supply Voltage: 120-265VAC | Beam Angle 120° | SMD Chipsets | Designed for general applications

| Code | Wattage | Lumens | Size (mm) | Spare Driver |
|----------------|---------|---------|----------------|------------------|
| GY225TG-10W-* | 10W | 900lm | 125 x 120 x 45 | DRV-GY225TG-10W |
| GY225TG-20W-* | 20W | 1800lm | 200 x 180 x 45 | DRV-GY225TG-20W |
| GY225TG-30W-* | 30W | 2700lm | 200 x 225 x 50 | DRV-GY225TG-30W |
| GY290TG-40W-* | 40W | 3600lm | 270 x 280 x 80 | DRV-GY290TG-40W |
| GY290TG-50W-* | 50W | 4500lm | 270 x 280 x 80 | DRV-GY290TG-50W |
| GY370FG-60W-* | 60W | 5400lm | 316 x 235 x 65 | DRV-GY370FG-60W |
| GY370FG-70W-* | 70W | 6300lm | 375 x 290 x 75 | DRV-GY370FG-70W |
| GY470TG-80W-WW | 80W | 7100lm | 375 x 290 x 75 | DRV-GY470TG-80W |
| GY470TG-100W-* | 100W | 9000lm | 375 x 290 x 75 | DRV-GY470TG-100W |
| GY490TG-150W-* | 150W | 14500lm | 455 x 330 x 95 | DRV-GY490TG-150W |
| GY490TG-200W-* | 200W | 18000lm | 455 x 330 x 95 | DRV-GY490TG-200W |

*Add colour to code: ○ WW (Warm White) 3000K, ○ CW (Cool White) 5500-6000K

NEW 3 Year Warranty



LED BK02 Low Profile Floodlights - IP65 | Supply Voltage: 180-265VAC | Beam Angle: 90° | Colour Temp: 6000K | CRI > 80 | 30 000hrs | Surge Protection: 10-20W 2kV, 20-100W 4kV, 150W 6kV, 200W 8kV | Aluminium Body

| Code | Wattage | Lumens | Size (mm) |
|--------------|---------|---------|----------------|
| BK02-10W-DL | 10W | 1000lm | 107 x 84 x 16 |
| BK02-20W-DL | 20W | 2000lm | 101 x 141 x 18 |
| BK02-30W-DL | 30W | 3000lm | 128 x 177 x 19 |
| BK02-50W-DL | 50W | 5000lm | 164 x 222 x 19 |
| BK02-100W-DL | 100W | 10000lm | 215 x 291 x 19 |
| BK02-150W-DL | 150W | 15000lm | 231 x 337 x 26 |
| BK02-200W-DL | 200W | 20000lm | 281 x 393 x 38 |

LED FLOODLIGHTS

NEW 5 Year Warranty



400W

LED IK02 Low Profile Floodlights - IP65 | Supply Voltage: 180-290VAC | Beam Angle: 90° | Colour Temp: 6000K | CRI > 80 | 50 000hrs | 5kV Surge Protection | Aluminium Body

| Code | Wattage | Lumens | Size (mm) |
|----------------|---------|---------|----------------|
| IK02-2-100W-DL | 100W | 11000lm | 236 x 203 x 26 |
| IK02-2-150W-DL | 150W | 16500lm | 276 x 231 x 30 |
| IK02-2-200W-DL | 200W | 22000lm | 266 x 312 x 31 |
| IK02-2-400W-DL | 400W | 44000lm | 440 x 590 x 20 |

5 Year Warranty



GY480TG
100W, 150W,
200W, 400W

120W, 150W, 180W

200W, 320W

400W

LED High Quality Floodlights - IP65 | Supply Voltage: 85-265VAC | LED Floodlights above 100W are supplied with Meanwell Drivers | Designed for industrial applications

| Code | Wattage | Lumens | Size (mm) | Spare Driver |
|-----------------|---------|---------|-----------------|------------------|
| GY480TG-100W-* | 100W | 9000lm | 350 x 300 x 70 | DRV-GY480TG-100W |
| GY480TG-150W-* | 150W | 18000lm | 450 x 348 x 60 | DRV-GY480TG-150W |
| GY480TG-200W-CW | 200W | 24000lm | 450 x 348 x 60 | DRV-GY480TG-200W |
| GY480TG-400W-* | 400W | 40000lm | 620 x 500 x 125 | DRV-GY480TG-400W |
| GY570FG-120W-* | 120W | 12000lm | 593 x 285 x 93 | DRV-GY570FG-120W |
| GY670S-150W-* | 150W | 15000lm | 451 x 311 x 202 | DRV-GY670S-150W |
| GY670S-180W-* | 180W | 18000lm | 451 x 311 x 202 | DRV-GY670S-180W |
| GY670S-200W-* | 200W | 20000lm | 525 x 365 x 185 | DRV-GY670S-200W |
| GY670S-320W-* | 320W | 32000lm | 525 x 365 x 185 | DRV-GY670S-320W |
| GY670S-400W-* | 400W | 40000lm | 580 x 320 x 190 | DRV-GY670S-400W |

*Add colour to code: ○ **WW** (Warm White) 3000K, ○ **CW** (Cool White) 5500-6000K



10W, 30W, 50W

100W

LED Slimline Floodlights - IP65 | Supply Voltage: 85-265VAC | Die-Cast Aluminium | Beam Angle: 110°

| Code | Wattage | Lumens | Size (mm) |
|-----------|---------|--------|-----------------|
| RW-A010-* | 10W | 650lm | 170 x 200 x 50 |
| RW-A030-* | 30W | 1950lm | 250 x 325 x 80 |
| RW-A050-* | 50W | 3250lm | 320 x 385 x 100 |
| RW-A100-* | 100W | 6500lm | 400 x 480 x 140 |

*Add Colour to Code: ○ **WW** (Warm White) 3000K, ○ **CW** (Cool White) 5500-6000K

5 Year Warranty



Sky 2.0 Floodlights - IP65 | Input Voltage: 230VAC | Driver on Board | Beam Angle: 90° | Removable cable entry for easy installation | Cable not supplied | SMD Chipset

| Code | Wattage | Lumens | Size (mm) |
|-------------------|---------|--------|----------------|
| YT-NP-FL16-10W-* | 10W | 900lm | 90 x 65 x 45 |
| YT-NP-FL16-20W-* | 20W | 1800lm | 100 x 70 x 45 |
| YT-NP-FL16-30W-* | 30W | 2700lm | 136 x 95 x 45 |
| YT-NP-FL16-50W-* | 50W | 4500lm | 180 x 126 x 37 |
| YT-NP-FL16-100W-* | 100W | 9000lm | 210 x 147 x 37 |

*Add Colour to Code: ○ **WW** (Warm White) 3000K, ○ **CW** (Cool White) 5500-6000K

NEW 5 Year Warranty

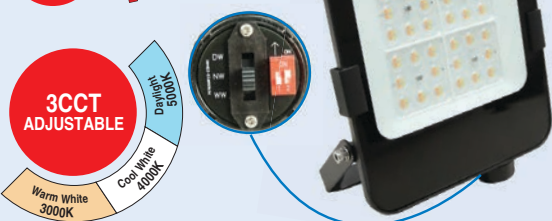

3CCT ADJUSTABLE

Daylight 5000K

Cool White 4000K

Warm White 3000K

3CCT and Power Adjustable Floodlight IP65 - 100-277VAC | 90° Beam Angle | 6kV Surge Protection | Colour Temp can be adjusted 3000K - 4000K - 6000K | Power Adjustable by Dip Switch

| Code | Wattage | Lumens | Size (mm) |
|--------------|---------------|---------|----------------|
| RW-RD-235-90 | 20 - 30 - 50W | 130lm/W | 232 x 213 x 44 |
| RW-RD-751-90 | 75 - 100W | 130lm/W | 330 x 265 x 48 |
| RW-RD-152-90 | 150 - 200W | 130lm/W | 412 x 360 x 45 |

LED FLOODLIGHTS

NEW

EMG



LED Floodlights with Emergency Backup Power IP65 - Input Voltage: 230VAC
| Beam Angle: 110° | Colour Temp. 6000K | 3 Hour Backup Time | Lithium Ion Battery

| Code | Wattage | Emg. Watts | Lumens | Size (mm) |
|---------------|---------|------------|---------|----------------|
| EMG-FL-50W-DL | 50W | 10W | 120lm/W | 219 x 188 x 41 |

NEW

32VAC



LED Boiler Inspection Floodlight IP65 - Input Voltage: 32VAC | Beam Angle: 110°
| Floodlight is used for boiler inspection applications

| Code | Wattage | Lumens | Size (mm) |
|---------------------|---------|--------|-----------------|
| FL3-AC-20W-CW 32VAC | 20W | 1600lm | 225 x 185 x 160 |
| FL3-AC-30W-CW 32VAC | 30W | 2400lm | 225 x 185 x 160 |



DC Floodlights - IP65 | Input Voltage: DC | Beam Angle: 110° | Other DC Voltages available on request



FL1

FL3

| Code | Wattage | Lumens | Size (mm) | Spare Driver |
|---------------|---------|--------|----------------|------------------|
| FL1-DC-10W-** | 10W | 800lm | 90 x 80 x 24 | DRV-FL1-DC-10W-* |
| FL3-DC-20W-** | 20W | 1600lm | 115 x 110 x 24 | DRV-FL3-DC-20W-* |
| FL3-DC-30W-** | 30W | 2400lm | 150 x 110 x 24 | DRV-FL3-DC-30W-* |
| FL3-DC-50W-** | 50W | 4000lm | 195 x 150 x 30 | DRV-FL3-DC-50W-* |

*Add Colour to Code: ○ WW (Warm White), ○ CW (Cool White)

*Add Volts to Code: 12VDC, 24VDC, 48VDC



Colour Floodlights - Input Voltage: 230VAC | Beam Angle 110° | Ideal for decorative applications

| Code | Wattage | Lumens | Size (mm) | Spare Driver |
|------------|---------|---------------------|----------------|------------------|
| FLC-10W-* | 10W | Dependant on colour | 115 x 86 x 86 | DRV-GY225TG-10W |
| FLC-20W-* | 20W | | 125 x 120 x 25 | DRV-GY225TG-20W |
| FLC-30W-* | 30W | | 185 x 180 x 25 | DRV-GY225TG-30W |
| FLC-50W-* | 50W | | 225 x 220 x 30 | DRV-GY290TG-50W |
| FLC-100W-* | 100W | | 375 x 290 x 75 | DRV-GY470TG-100W |
| FLC-20W-UV | 20W | 1600lm | 130 x 120 x 40 | - |

*Add Colour to Code: ● R (Red), ● GN (Green), ● BL (Blue), ● Y (Yellow)



Colour Changing Floodlights - IP65 | Input Voltage: 100-240VAC | Beam Angle 110° | 16 Million Colours + White

| Code | Wattage | Lumens | Size (mm) | Spare Driver |
|---------------|---------|---------------------|----------------|-------------------|
| FLC-20W-RGBW | 20W | Dependant on colour | 124 x 100 x 24 | DRV-FLC-20W-RGBW |
| FLC-30W-RGBW | 30W | | 159 x 122 x 26 | DRV-FLC-30W-RGBW |
| FLC-50W-RGBW | 50W | | 205 x 160 x 34 | DRV-FLC-50W-RGBW |
| FLC-100W-RGBW | 100W | | 270 x 210 x 34 | DRV-FLC-100W-RGBW |

c/w Remote Control to Change Colour RGBW ●●●○

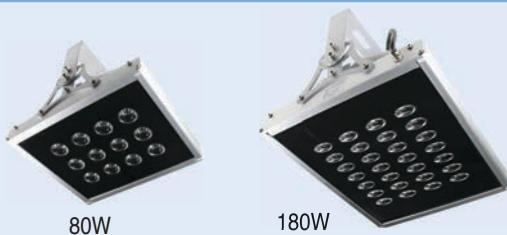

80W

180W

LED Narrow Beam Floodlights - IP65 | Input Voltage: 90-265VAC | Beam Angle: 10° | Colour Temp.: 6500K

| Code | Wattage | Lumens | Size (mm) |
|------------|---------|---------|-----------------|
| SS-FL-80W | 80W | 7000lm | 240 x 285 x 150 |
| SS-FL-100W | 100W | 8400lm | 300 x 285 x 150 |
| SS-FL-120W | 120W | 10700lm | 360 x 285 x 150 |

1 Year Warranty

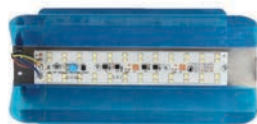

Economy LED Flood Light - Input Voltage: 230VAC | 6500K

| Code | Wattage | Lumens | Size (mm) |
|------------|---------|--------|----------------|
| ECHO-50-CW | 50W | 2600lm | 250 x 130 x 50 |

LED SPORT FLOODLIGHTS

5 Year Warranty

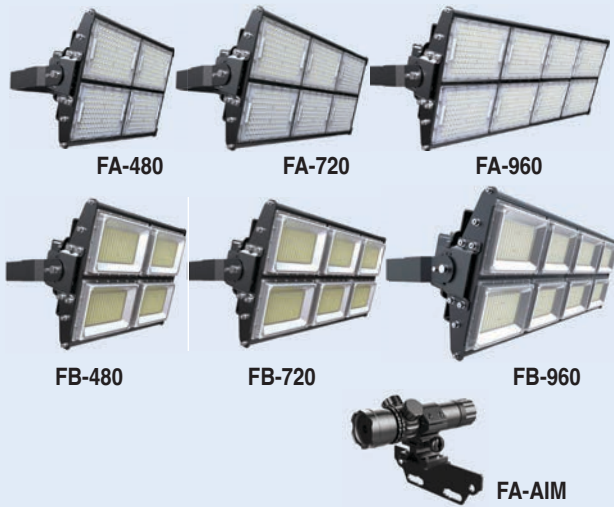

LED Stadium Floodlights - IP65 | Input Voltage: 100-277VAC | Phillips LumiLEDs | Meanwell Driver | Colour Temp: 5500K | Ideal for Stadium Lighting

| Code | Wattage | Lumens | Beam Angle | Size (mm) |
|---------------|---------|-----------|------------|------------------|
| FA-480-30 | 480W | 52 200lm | 30° | 630 x 500 x 285 |
| FA-720-30 | 720W | 82 800lm | 30° | 885 x 500 x 285 |
| FA-960-30 | 960W | 110 400lm | 30° | 1145 x 500 x 285 |
| FA-480-60X100 | 480W | 52 200lm | 60° x 100° | 630 x 500 x 285 |
| FA-720-60X100 | 720W | 82 800lm | 60° x 100° | 885 x 500 x 285 |
| FA-960-60X100 | 960W | 110 400lm | 60° x 100° | 1145 x 500 x 285 |
| FB-480-120 | 480W | 60 000lm | 120° | 630 x 500 x 285 |
| FB-720-120 | 720W | 90 000lm | 120° | 885 x 500 x 285 |
| FB-960-120 | 960W | 120 000lm | 120° | 1145 x 500 x 285 |

Accessories

| Code | Description |
|--------|----------------------------------------|
| FA-AIM | Laser Aiming device for LED Floodlight |

NEW



G2 Stadium Floodlights - IP66 | Input Voltage: 100-277VAC | 5500K | CRI >70 | 30°/45°/80° (150lm/W) | 15° (130lm/W) | c/w 10kV SPD | Operating Temp.: -40°C to 50°C | Remote Gear | Glare Control Lens | Applications: Stadiums, Arenas, Golf Courses, Courts | Available in 15°, 30°, 45°, 80° Beam Angles

| Code | Wattage | Lumens | Size (mm) |
|----------------|---------|-----------|------------|
| ST-RSL-500W-* | 500W | 75 000lm | Ø495 x 236 |
| ST-RSL-600W-* | 600W | 90 000lm | Ø495 x 236 |
| ST-RSL-800W-* | 800W | 120 000lm | Ø495 x 236 |
| ST-RSL-1000W-* | 1000W | 150 000lm | Ø495 x 236 |
| ST-RSL-1200W-* | 1200W | 180 000lm | Ø495 x 236 |

* Add Beam Angle to Code: **15** (15°), **30** (30°), **45** (45°), **80** (80°)



LED Asymmetrical Floodlights - IP65 | Input Voltage: 170-240VAC | Colour Temperature: 6500K | Concentrated Beam Angle | Suitable for Sports & Area Lighting

| Code | Wattage | Lumens | Size (mm) |
|--------------|---------|--------|----------------|
| NP-FL03-80W | 80W | 6400lm | 255 x 87 x 290 |
| NP-FL03-100W | 100W | 8000lm | 255 x 87 x 290 |

5 Year Warranty



LED Stadia Floodlight - IP66 | Input Voltage: 100-277VAC | 140lm/W | RA80 | PF > 0.9 | Beam Angles 30° / 60° / 90° / 80° x 140° | Colour Temperature: 6000K | Ideal for Highmast lighting & Sport facilities

| Code | Wattage | Lumens | Size (mm) |
|-------------------|---------|---------|----------------|
| YT-NP-FL07-75W-* | 75W | 10125lm | 365 x 310 x 60 |
| YT-NP-FL07-100W-* | 100W | 13500lm | 365 x 310 x 60 |
| YT-NP-FL07-150W-* | 150W | 20250lm | 365 x 365 x 60 |
| YT-NP-FL07-200W-* | 200W | 27000lm | 365 x 420 x 60 |
| YT-NP-FL07-300W-* | 300W | 40500lm | 387 x 590 x 63 |
| YT-NP-FL07-400W-* | 400W | 54000lm | 387 x 590 x 63 |

* Add Beam Angle to Code: **N**(30°), **M**(60°), **W**(90°), **MW**(80° x 140°). Only Stocking **W**(90°) other Beam Angles on Request only.

LED SPORT FLOODLIGHTS

5 Year Warranty



Dragon Stadium Floodlight - IP66 - Input Voltage: 100-277VAC | 5700K | 150lm/W | L70B10 50000hrs | 360° Rotatable Module | Tempered Glass, PMMA Lens | Ideal for Sport fields & Stadiums

| Code | Wattage | Lumens | Beam Angle | Size (mm) |
|------------------|---------|-----------|------------|-------------------|
| B-240W-30-DL | 240W | 36 000lm | 30° | 745 x 332 x 172 |
| B-500W-30-DL | 500W | 75 000lm | 30° | 745 x 594 x 172 |
| B-800W-30-DL | 800W | 120 000lm | 30° | 745 x 817 x 172 |
| B-1000W-40-30-DL | 1000W | 150 000lm | 30° | 911 x 1125 x 181 |
| B-1500W-40-30-DL | 1500W | 225 000lm | 30° | 1139 x 1125 x 181 |



LED MODULAR FLOODLIGHTS

5 Year Warranty



LED Adjustable Floodlights - IP65 Input Voltage: 230VAC | Colour Temp: 6500K | Modular and adjustable | Suitable for Sports Fields, Warehouses, Gymnasiums, Workshops, Gas Stations, Toll Stations, Parking Areas, etc.

| Code | Wattage | Lumens | Size (mm) |
|------------|---------|----------|-----------------|
| HBB-HD-C1 | 50W | 7000lm | 310 x 85 x 120 |
| HBB-HD-C2 | 100W | 14000lm | 310 x 176 x 120 |
| HBB-HD-C3 | 150W | 21000lm | 310 x 267 x 120 |
| HBB-HD-C4 | 200W | 28000lm | 310 x 360 x 120 |
| HBB-HD-C6 | 300W | 42000lm | 310 x 542 x 120 |
| HBB-HD-C8 | 400W | 56000lm | 310 x 726 x 120 |
| HBB-HD-C10 | 500W | 70000lm | 310 x 910 x 120 |
| HBB-HD-C12 | 600W | 84000lm | 610 x 542 x 120 |
| HBB-HD-C16 | 800W | 112000lm | 610 x 726 x 120 |
| HBB-HD-C20 | 1000W | 140000lm | 610 x 910 x 120 |

LED Adjustable Floodlights - IP65 | Input Voltage: 85-265VAC | Colour Temp.: 6500K | LED Modules are Adjustable | Working Temperature -40°C - +60°C

| Code | Wattage | Lumens | Size (mm) |
|---------|---------|--------|-----------------|
| CE33-DL | 40W | 4200lm | 238 x 102 x 178 |
| CE37-DL | 80W | 8400lm | 238 x 102 x 178 |
| CE46-DL | 160W | 6800lm | 425 x 219 x 227 |

Modular LED Floodlight - IP66 | Input Voltage: 230VAC | Beam Angle 110° | Colour Temp: 6500K | Driver on board | Modular design to allow more fittings to be added horizontally | Optional bracket required when adding fittings.

| Code | Wattage | Lumens | Size (mm) |
|--------------|---------|--------|----------------|
| YT-TG-09-DOB | 50W | 4500lm | 240 x 115 x 35 |

Accessories

| Code | Description |
|----------|------------------------------------------------------|
| YT-TG-BK | Bracket for adding additional fittings (2 Per Pack) |

NEW



LED FLOODLIGHTS

NEW



C2440-GW-18-DL

C2440-HW-36-DL

LED PIR Motion Sensor Floodlight IP65 - Colour Temp: 5000K | 180° Adjustable Head | 180° Motion Detection | 4 Smart Working Modes: Auto, On-time, Dusk to Dawn, Test mode | Adjustable Sensing Features, Lux, Time and Range

| Code | Wattage | Lumens | Size (mm) |
|----------------|---------|--------|-----------------|
| C2440-GW-18-DL | 18W | 1800lm | 227 x 190 x 179 |
| C2440-HW-36-DL | 36W | 3600lm | 231 x 188 x 183 |

LED MOTION SENSOR FLOODLIGHTS

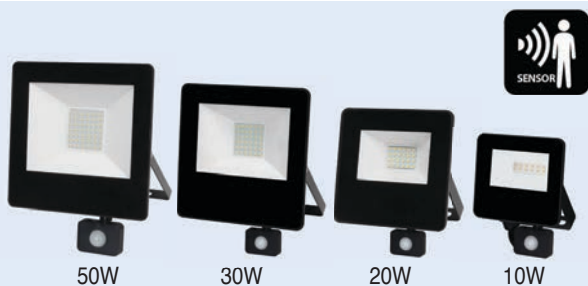

50W

30W

20W

10W



LED PIR Motion Sensor Floodlight - IP65 | Input Voltage: 230VAC

| Code | Wattage | Lumens | Size (mm) |
|---------------|---------|--------|----------------|
| PR225TG-10W-* | 10W | 800lm | 135 x 90 x 25 |
| PR225TG-20W-* | 20W | 1600lm | 175 x 125 x 25 |
| PR225TG-30W-* | 30W | 2400lm | 235 x 185 x 25 |
| PR225TG-50W-* | 50W | 4000lm | 275 x 225 x 30 |

*Add colour to code: ○ **CW** (Cool White) 5500-6000K, ○ **WW** (Warm White) 3000K



WP05-10W-DL

WP05-20W-DL

S1707A-20



LED PIR Motion Sensor Floodlight - IP54 | Input Voltage: 230VAC | Colour Temperature: 6500K | ABS Body | PC Diffuser | PIR Sensor | Adjustable Head

| Code | Wattage | Lumens | Size (mm) |
|-------------|---------|--------|-----------------|
| WP05-10W-DL | 10W | 800lm | 152 x 140 x 230 |
| WP05-20W-DL | 20W | 1600lm | 134 x 350 x 236 |

Aluminium Adjustable Spot Head with PIR - IP54 | Input Voltage: 230VAC | Colour Temperature: 6500K | Robust Aluminium Body | Time Adjustable 3s - 7min | Motion Sensor 140° | 20 - 20 000 lux | Max 12m Sensing

| Code | Wattage | Lumens | Size (mm) |
|-----------|---------|--------|-----------------|
| S1707A-20 | 20W | 1600lm | 283 x 189 x 130 |

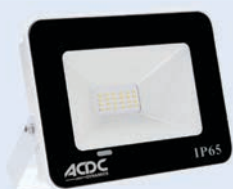

LED Floodlight Microwave Motion & Day/Night Sensor - IP65 | Input Voltage: 230VAC | Material: Plastic

| Code | Wattage | Lumens | Size (mm) |
|--------------|---------|--------|----------------|
| PIR-N-10W-* | 10W | 800lm | 150 x 116 x 36 |
| PIR-N-20W-* | 20W | 1600lm | 150 x 116 x 36 |
| PIR-N-30W-* | 30W | 2400lm | 170 x 130 x 36 |
| PIR-N-50W-* | 50W | 4000lm | 230 x 170 x 36 |
| PIR-N-100W-* | 100W | 8000lm | 390 x 290 x 36 |

*Add colour to code: ○ **CW** (Cool White) 5500-6000K, ○ **WW** (Warm White) 3000K

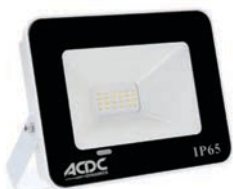

LED Day/Night Sensor Floodlight - IP65 | Input Voltage: 230VAC | Material: Plastic

| Code | Wattage | Lumens | Size (mm) |
|-------------|---------|--------|----------------|
| DN-N-10W-* | 10W | 800lm | 150 x 110 x 36 |
| DN-N-20W-* | 20W | 1600lm | 150 x 110 x 36 |
| DN-N-30W-* | 30W | 2400lm | 170 x 130 x 36 |
| DN-N-50W-* | 50W | 4000lm | 230 x 170 x 36 |
| DN-N-100W-* | 100W | 8000lm | 390 x 290 x 36 |

*Add colour to code: ○ **CW** (Cool White) 5500-6000K, ○ **WW** (Warm White) 3000K

NEW

SMART SKY LED FLOODLIGHTS



WF-FL17-20W-CW/WW

WF-FL17-20W-RGBW



Music

Input Voltage: 230VAC | 110° Beam Angle

| Code | Wattage | Lumens | Size (mm) |
|-------------------|---------|--------|----------------|
| WF-FL17-20W-CW/WW | 20W | 2000lm | 162 x 36 x 144 |
| WF-FL17-20W-RGBW | 20W | 2000lm | 162 x 36 x 144 |



WiFi Control

App Control

Remote Switching

Dimmable

Set Timers & Schedules

Scenes Control

Colour Temp. Adjustable

LED FLOODLIGHT ACCESSORIES



| Code | Description |
|----------|-----------------------------------------------------|
| GY-SPIKE | Garden spike for ALL LED Floodlights up to 50 Watts |

LED SPOT LIGHT IP65



Input Voltage: 230VAC

| Code | Wattage | Lumens | Size (mm) |
|---------------|---------|--------|-----------------|
| ZL-L3222P-* | 28W | 2380lm | 260 x 272 x 86 |
| ZL-L3222L-* | 30W | 2300lm | 260 x 272 x 86 |
| ZL-L3223A-CW | 80W | 1100lm | 190 x 278 x 86 |
| NLG08-08A-* | 24W | 2000lm | 230 x 354 |
| GY290TS-30W-* | 30W | 2400lm | 290 x 236 x 206 |
| GY290TS-40W-* | 40W | 3200lm | 290 x 236 x 206 |
| GY290TS-50W-* | 50W | 4000lm | 290 x 236 x 206 |

*Add colour to code: ○ CW (Cool White) 5500-6000K, ○ WW (Warm White) 3000K

LED WORK LIGHTS IP65



Floor Standing Work Light - Input Voltage: 230VAC | Colour Temp. 6500K
120° Beam Angle

| Code | Wattage | Lumens | Size (mm) |
|--------------|---------|--------|-----------------|
| NLG08-08C-* | 24W | 2400lm | 410 x 354 |
| WS225TG-20W | 20W | 2000lm | 250 x 190 x 160 |
| WS225TG-30W | 30W | 3000lm | 260 x 220 x 160 |
| WS225TG-50W | 50W | 5000lm | 330 x 270 x 180 |
| WS225TG-100W | 100W | 8450lm | 400 x 350 x 230 |

NEW



Tripod Work Lights - Input Voltage: 230VAC | Colour Temp. 6500K | c/w 2 meter mains cable and plug

| Code | Wattage | Lumens | Size (mm) | Spare Stand |
|---------------|---------|---------|------------|---------------|
| NLG08-08B | 24W | 2400lm | 1650 x 295 | - |
| NLG08-08B2 | 2 x 24W | 4800lm | 1650 x 600 | - |
| WP225T1-20W-* | 20W | 2000lm | 1650 x 500 | WP225T1-STAND |
| WP225T1-30W-* | 30W | 3000lm | 1650 x 295 | WP225T1-STAND |
| WP225T1-50W-* | 50W | 5000lm | 1650 x 295 | WP225T1-STAND |
| WP225T2-20W-* | 2 x 20W | 4000lm | 1650 x 500 | WP225T2-STAND |
| WP225T2-30W-* | 2 x 30W | 6000lm | 1650 x 600 | WP225T2-STAND |
| WP225T2-50W-* | 2 x 50W | 10000lm | 1650 x 500 | WP225T2-STAND |

*For Low Voltage add: 12VDC, 24VDC

PORTABLE LIGHTS C/W BATTERY



Rechargeable | c/w charger & car charger | Material: ABS Plastic | IP65

| Code | Wattage | Battery Type | Battery Life | Size | Colour Temp |
|----------|---------------|----------------------|--------------|-----------|-------------|
| SP-W806A | 180LEDs (13W) | 12V, 7Ah (Lead Acid) | 3hrs | 450 x 300 | DL (6000K) |

Rechargeable | c/w charger & car charger | Material: Die-Cast Aluminium | IP65

| Code | Wattage | Battery Type | Battery Life | Size | Colour Temp |
|-----------|---------|---------------------|--------------|-----------------|-------------|
| PFL-5W-* | 5W | 7.4V, 2200mAh (Li) | 3hrs | 145 x 166 x 255 | DL / RGB |
| PFL-10W-* | 10W | 7.4V, 2200mAh (Li) | 3hrs | 145 x 166 x 255 | RGB |
| PFL-20W-* | 20W | 14.8V, 4400mAh (Li) | 3hrs | 215 x 185 x 295 | RGB |

*Add colour to code: ○ DL (Daylight) 6500K, ●●● RGB (Colour Changing)



LED Work Light - Operating Mode: High - Low - SOS - Off | USB Input Charging | USB Output for mobile device charging | Material: Nylon | IP44

| Code | Watts | Lumens | Battery Type | Battery Life | Size | Colour Temp |
|--------------|-------|--------|-------------------------|------------------------|----------------|-------------|
| WL03-COB-10W | 10W | 750lm | 7.4V, 2 x 2200mAh (Li) | 3hrs High 10hrs Low | 173 x 127 x 45 | DL (6000K) |
| WL03-COB-20W | 20W | 1800lm | 11.1V, 3 x 2000mAh (Li) | 3hrs High 8hrs Low | 173 x 127 x 45 | DL (6000K) |

PORTABLE LIGHTS C/W BATTERY



CFL - IP65 | Lamps included | Rechargeable | Material: Plastic

| Code | Wattage | Battery Type | Working Time | Colour Temp |
|------------|---------------|-----------------------|---------------------------|-------------|
| E84W/24A | 2 x 42W (CFL) | 24Ah Sealed Lead acid | 1 lamp:7hrs/2 lamp:3.5hrs | DL (6000K) |
| E84W/24A-E | 2 x 42W (CFL) | 24Ah Sealed Lead acid | 1 lamp:7hrs/2 lamp:3.5hrs | DL (6000K) |

LED - IP65 | Lamps included | Rechargeable | Material: Aluminium

| | | | | |
|----------|-----------|-------------|------|------------|
| E2410-30 | 30W (LED) | 10Ah Li-Ion | 7hrs | DL (6000K) |
|----------|-----------|-------------|------|------------|

Explosion Proof - IP65 | c/w wheels & 2 light levels selectable | Material: Aluminium Alloy | Ex de II C T6

| | | | | |
|--------|-----------|-----------------------|--------------------------|------------|
| BW3210 | 30W (LED) | 12Ah Sealed Lead acid | High: 16hrs / Low: 36hrs | DL (6000K) |
|--------|-----------|-----------------------|--------------------------|------------|

FLP

NEW



DC Work Light IP54 - IK07 | Plastic Body + Steel Tripod | 2m Power Cord | 216pcs SMD LED | 6500K | 18.5V 4400mAh | Li-ion Battery | 21V 1A AC230V Charger | 2 Working Modes: 100% - 3100lm @ 2.8hrs, 30% - 1000lm @ 9.2hrs / Ideal for Remote Work Sites

| Code | Wattage | Lumens | Battery | Size (mm) | Colour |
|------------|---------|---------|----------------------|--------------------|--------|
| WL10621-30 | 30W | 105lm/W | 18.5V 4400mAh Li-ion | Ø670 x 1126 (open) | 6500K |

LED Mobile Emergency Lighting in Case IP67 - Colour Temp: 6500K | c/w Built-In Charger | c/w Batteries | c/w Wheels for easy transportation

c/w Wheels



| Code | 5JG-RL9972 | RLS512722-72W | RLS584433-144W |
|----------------------|-------------------------------------|-------------------------------------|-------------------------------------|
| Lamp Power | 36W | 72W | 144W |
| Lumen (High/Med/Low) | 2100/1255/884lm | 4000/2000/1500 | 8000/4000/2000 |
| Total Weight | 14.5kg | 22kg | 32kg |
| Battery Type | 12V 10Ah Lithium | 12V 24Ah | 12V 33Ah |
| Working Time hrs | 33hrs (low)/17hrs (med)/8hrs (high) | 26hrs (low)/14hrs (med)/7hrs (high) | 28hrs (low)/16hrs (med)/8hrs (high) |
| Charge Time | 5.5hrs | 6-8hrs | 6-8hrs |
| Spare Battery Code | RLS-963L-BAT | RLS512722-BAT | RLS584433-BAT |

LED BILLBOARD LIGHTS IP65

SOL2 SOLAR



Solar Billboard Floodlight - Colour Temperature: 5500K | Working Hours: 4-6Hrs, 3-5Hrs (Rainy Day) | Charging Time: 6-8Hrs | Life PO4 Battery

| Code | Solar Panel | Light Source | Lumen | Size (mm) | Weight (Kg) |
|---------|-------------|--------------|--------|------------------|-------------|
| LFA-24W | 18V / 60W | 24W CREE LED | 2640lm | 1155 x 355 x 185 | 23 |
| LFA-36W | 18V / 60W | 36W CREE LED | 3960lm | 1155 x 480 x 185 | 35 |

LED

- 230VAC
- c/w arm



LED Billboard Floodlight - Input Voltage 230VAC | c/w Mounting Arm

| Code | Power | Lumen | Size (mm) |
|--------------|-------|--------|------------------------------|
| ZL-L3221PB-* | 12W | 1020lm | 190 (wide) x 835 (incl. arm) |
| ZL-L3221QB-* | 20W | 1700lm | 190 (wide) x 835 (incl. arm) |

*Add colour to code: ○ CW (Cool White) 4200K, ○ WW (Warm White) 2700-3000K

BILLBOARD LIGHT SERIES

Metal Halide
230VAC
Lamp excluded

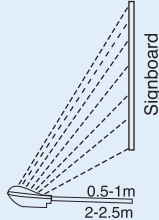

Adjustable Arms for Mounting Floodlights

Powder coated black.
Light fitting excluded.

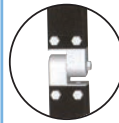

Joints can rotate
through 270°



| Code | GG01 | GG012 | GG01-EMPTY | Code | JM-ZJ-01 | JM-ZJ-02 | JM-ZJ-03 |
|-----------|--------------|--------------|------------|--------------------|-----------------|-------------------------------|-------------------------------|
| Wattage | 250W | 400W | 400W Max | Description | 600mm fixed arm | 1200mm hinged arm (2 x 600mm) | 1800mm hinged arm (3 x 600mm) |
| Lamp Type | E40/ MTE-250 | E40/ MTE-400 | CFL/LED | Max Fitting Weight | 32kg | 14kg | 14kg |
| IP Rating | IP65 | IP65 | IP65 | | | | |

LED WALL WASHER FLOODLIGHTS IP65

RGB
16 Million
Static Colour
Shows



RGB
Beam
angle 25°



Single
Colour



| Code | LW-AL-300 | LW-003-RGB | SL-T204* |
|----------------|--------------------|----------------------------|---------------------|
| Power | 25W/3A | R:12, G:12, B:12 (36 x 1W) | 24 x 1W (24W) |
| Lumen | 371lm | 371lm | 2000-2300lm (White) |
| Size (mm) | 300L x 145W x 225H | 343L x 150W x 214H | 330L x 160mm |
| Light Distance | 20m | 10m | 10m |
| DMX Controller | SRC-174 | Independent and DMX512 | No DMX |
| Supply Volts | 90-264VAC | 100-240VAC | 230VAC |

*Add colour to code: ● R (Red), ● GN (Green), ● BL (Blue), ● Y (Yellow), ○ PW (Pure White)



RGB LED Wall Washer - 100-256VAC | • Beam Angle 30° | c/w wall brackets

| Code | Size (mm) | LED Qty | LED Power | Total Power |
|-----------------|----------------|----------------|-----------|-------------|
| LW-020-RGB | 500 x 45 x 62 | R:4 G:4 B:4 | 12 x 1W | 15W |
| LW-021-RGB | 850 x 45 x 62 | R:8 G:8 B:8 | 24 x 1W | 30W |
| LW-022-RGB | 1000 x 45 x 62 | R:12 G:12 B:12 | 36 x 1W | 40W |
| LW-022-RGB-AUTO | 1000 x 45 x 62 | R:12 G:12 B:12 | 36 x 1W | 40W |

LED Wall Washer IP66 - Input Voltage: 240VDC | High Strength Aluminium Housing + Tempered Glass | c/w Mounting Bracket



| Code | Wattage | Colour | Beam Angle | Control | Size (mm) |
|-------------|---------|--------------------|------------|---------|----------------|
| ELI-LW-2626 | 15W | Cool White (4200K) | 120° | Steady | 1000 x 26 x 26 |
| ELI-LW-3026 | 24W | RGB | 30° | DMX 512 | 1000 x 30 x 26 |
| ELI-LW-4226 | 36W | RGBW | 15° | DMX 512 | 1000 x 30 x 26 |

Supply Voltage:
230VAC

RGB

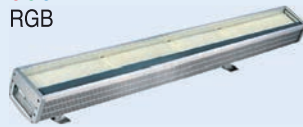

RGB



RGB

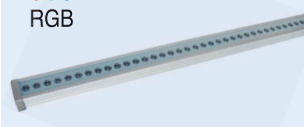

Indoor IP20

RGB 110-240VAC
Sound active, auto run mode, colour
strobe, dimmer, colour mixing, colour
water flow & chasing effects

| Code | LW-008 | LW-009 | LW-024 | LW-WF-F10-252 |
|-----------|----------------------------|---------------------|--------------------|---------------------------|
| Power/max | 1440 x 5mm LEDs (112W max) | 144 x 1W (220W max) | 36 x 1W (56W max) | 252 x 10mm LEDs (50W max) |
| Lumen | 1187lm | 1482lm | 1112lm | 480lm |
| Size (mm) | 1240L x 150W x 172H | 1240L x 150W x 172H | 1120L x 76W x 163H | 1240L x 76W x 163H |

Independent and DMX Mode Available beam angle 25°. DMX controller: DMX-512

FLOODLIGHTS - INDUCTION IP65



| Code | EDC*-DL | VF*-DL | JM-JN* |
|--------------------|-----------------|-------------|-----------------|
| *Add watts to code | 80W, 100W | 200W, 300W | 80W, 120W, 200W |
| lm/W | 80lm | 80lm | 80lm |
| Colour Temp | 5000-5500K | 5000-5500K | 6500K |
| Size (mm) | 450 x 450 x 155 | Ø430 x H350 | 440 x 410 x 140 |

FLOODLIGHTS - ENERGY SAVING IP65

Lamp supplied: Daylight 6500K.
For spare lamps, see page 20



DF-65CFL



DF-180CFL

Energy Saving Floodlights - c/w lamp 230VAC

| Code | Watts | Lamp Holder | Light Fitting | Lamp Code | Size (mm) |
|-----------|-------|-------------|---------------|-----------------|-----------------|
| DF-30CFL | 30W | E27 | - | - | 270 x 202 x 132 |
| DF-45CFL | 45W | E40 | F2012 | - | 395 x 224 x 165 |
| DF-065CFL | 65W | E40 | - | ESL42-65-E40-D | 410 x 300 x 139 |
| DF-105CFL | 105W | E40 | - | - | 410 x 300 x 139 |
| DF-125CFL | 125W | E40 | FL1028 | ESL42-125-E40-D | 580 x 475 x 168 |

Lamp supplied: Daylight 6500K

| | | | | | |
|-----------|------|-----|--------|-----------------|-----------------|
| DF-150CFL | 150W | E40 | FL1028 | ESL42-150-E40-D | 580 x 475 x 168 |
| DF-180CFL | 180W | E40 | FL1028 | ESL42-180-E40-D | 580 x 475 x 168 |
| DF-200CFL | 200W | E40 | FL1028 | ESL42-200-E40-D | 580 x 475 x 168 |

Energy Saving Floodlights - Lamp to be ordered separately. See page 18-19

| Code | Lamp Holder | Watts | Size(mm) H x W x D | Lamp Type |
|--------------|-------------|---------|--------------------|------------|
| LD3001-2X26W | G24q3 | 2 x 26W | 290 x 240 x 115 | PLCE-26-CW |
| LD3001-4X26W | G24q3 | 4 x 26W | 450 x 325 x 130 | PLCE-26-CW |

Empty Floodlights - Lamp to be ordered separately. See page 20.

| | | | | |
|-----------|-----|------|-----------------|------------------|
| LD3001-50 | E27 | 70W | 290 x 240 x 115 | ESL42-45-E27-S-M |
| LD3001-51 | E40 | 150W | 400 x 325 x 130 | ESL42-65-E40-S-M |
| LD3001-52 | E40 | 400W | 400 x 420 x 170 | ESL42-150-E40-D |



LD3001-2X26W LD3001-4X26W LD3001-51

PLASTIC ENERGY SAVING FLOODLIGHTS

Supply Voltage
230VAC
Lamps Included
Cool White 4000K



Lamps excluded



Electronic Ballast



Electronic Ballast



Electronic Ballast

| Code (c/w lamp) | BL070 | FLN001-65 | FL1063-18 | FL1063-26 | FL1063-42 |
|-----------------|-----------------------|-----------------|-----------------|-----------------|-----------------|
| Wattage/Lamp | 2 x 23W | 2 x 65W | 2 x 18W | 2 x 26W | 2 x 42W |
| Spare Lamp | FE35-26-E27 | ESL42-65-E27-D | PLC-18-CW | PLC-26-CW | PLCE-42-CW |
| IP Rating | IP65 | IP65 | IP65 | IP65 | IP65 |
| Material | High Strength Plastic | Plastic | Plastic | Plastic | Plastic |
| Size (mm) | 260 x 260 x 105 | 338 x 430 x 118 | 315 x 235 x 125 | 315 x 235 x 125 | 390 x 325 x 135 |

FLOODLIGHTS - HID

High Pressure Sodium Floodlight IP55

Metal Halide Floodlight IP55

Mercury Vapour Floodlight IP55

| Watts | Code Symmetrical | Code Asymmetrical | Lamps | Lamp Holder | Code Symmetrical | Code Asymmetrical | Lamps | Lamp Holder | Code Symmetrical | Code Asymmetrical | Lamps | Lamp Holder |
|-------|------------------|-------------------|---------|-------------|------------------|-------------------|----------|-------------|------------------|-------------------|--------|-------------|
| 70W | DF-070HPS-S | DF-070HPS-A | ST-70 | RX7s | DF-070MH-S | DF-070MH-A | MD-70 | Rx7s | - | - | - | - |
| 125W | - | - | - | - | - | - | - | - | - | DF-125MV-A | QE-125 | E27 |
| 150W | DF-150HPS-S | DF-150HPS-A | ST-150 | RX7s | DF-150MH-S | DF-150MH-A | MD-150 | Rx7s | - | - | - | - |
| 250W | DF-250HPS-S | DF-250HPS-A | SD-250 | E40 | DF-250MH-S | DF-250MH-A | MT-250 | E40 | DF-250MV-S | DF-250MV-A | QE-250 | E40 |
| 400W | DF-400HPS-S | DF-400HPS-A | SD-400 | E40 | DF-400MH-S | DF-400MH-A | MT-400 | E40 | DF-400MV-S | - | QE-400 | E40 |
| 1000W | DF-1000HPS-S | DF-1000HPS-A | SD-1000 | E40 | DF-1000MH-S | DF-1000MH-A | MTE-1000 | E40 | - | - | - | - |

For Metal Halide Blue Light 400W use lamp code JLZ400W-B (See page 26)

Order Lamps separately see page 25-26



For 70W & 150W
Asymmetrical



For 250W & 400W
Symmetrical



For 250W & 400W
Asymmetrical



For 1000W Asymmetrical
(Supplied with Vossloh-Schwabe ballast)



For 1000W Symmetrical

(Supplied with Vossloh-Schwabe ballast)

FLOODLIGHTS - HID



Metal Halide Plastic Floodlights IP65

Stainless Steel 304 Bracket. C/w control gear. Lamps excluded, see page 25-26.

| Code | Lamp Holder | Watts | Size(mm) H x W x D | Lamp Type |
|------------|-------------|-------|--------------------|-----------|
| LD3001-70 | Rx7s | 70W | 290 x 240 x 115 | MD-70 |
| LD3001-400 | E40 | 450W | 400 x 420 x 170 | MT-400 |

EMPTY FLOODLIGHTS

Supply Voltage
230VAC
IP55



| Code | FL1061-ASY | NB1025 ASY | NB1029-RX7 ASY | F2010 ASY | NB1029-E27 SYM |
|-------------|-----------------|-----------------|----------------|-----------------|----------------|
| Type | Asymmetrical | Asymmetrical | Asymmetrical | Asymmetrical | Symmetrical |
| Lamp Holder | E40 | E40 | Rx7s/118 | E40 | E27 |
| Wattage | 1000W | 400W | 70/150W | 250/400W | 70/150W |
| Size (mm) | 650 x 550 x 205 | 410 x 420 x 145 | 230 x 350 x 85 | 435 x 410 x 158 | 230 x 350 x 85 |

Supply Voltage
230VAC
IP55



| Code | NB1025 SYM | FL1061-SYM | FL1001 | FL1002 | FL1003 |
|-------------|-----------------|-----------------|-----------------|-----------------|-----------------|
| Type | Symmetrical | Symmetrical | Symmetrical | Symmetrical | Symmetrical |
| Lamp Holder | E40 | E40 | E27 | E40 | E40 |
| Wattage | 400W | 1000W | 70/150W | 250/400W | 1000W |
| Size (mm) | 410 x 420 x 145 | 650 x 517 x 227 | 290 x 225 x 190 | 415 x 320 x 260 | 568 x 435 x 420 |

Supply Voltage
230VAC

IP55



IP65



Plastic

IP65



Plastic

IP54



| Code | FL1028 | FL1063-E40 | FL1063-E27 | F2012 |
|-------------|-----------------|-----------------|-----------------|-----------------|
| Type | Symmetrical | Symmetrical | Symmetrical | Symmetrical |
| Lamp Holder | E40 | E40 | 2 x E27 | E40 |
| Wattage | 70/150W | 250/400W | 70/150W | 70/150W |
| Size (mm) | 600 x 480 x 168 | 390 x 325 x 135 | 315 x 235 x 125 | 395 x 224 x 165 |

HIGH MAST & STADIUM HID FLOODLIGHTS



Asymmetrical High Performance - IP66 Narrow beam reflector | Sports field lighting | High mast lighting | Security lighting | Area lighting | Airport aprons | Lamps Not Included - See page 25-26 for lamps

| Code | Lamp Holder | Wattage | Size (mm) |
|------------|-------------|---------|-----------------|
| AF-400-* | E40 | 400W | 360 x 450 x 185 |
| AF-600-HPS | E40 | 600W | 360 x 450 x 185 |

*Add type of switchgear required to code: **MH** (Metal Halide), **HPS** (High Pressure Sodium)

Stadium - IP65 High efficiency light output | Multiple optics - Beam angle adjustable | Perfect solution for stadium lighting designs | Lamps and control gear to be ordered separately

| Code Head Piece | Lamp Holder | Wattage | Size (mm) | Lamp Code |
|-----------------|---------------------|---------|-----------------|-----------------------|
| YGTH-1000-A1 | X528 (Double Ended) | 1000 | 535 x 556 x 242 | HQI-TS-1000 |
| YGTH-2000-A1 | | 2000 | | HQI-TS-2000(Long Arc) |

Control Gear IP65 - To be ordered Separately

| Code Gearbox | Description | Size (mm) |
|--------------|-------------------------------------------------------|-------------------|
| YGTH-GB-1000 | 230V, 1000W Gear tray in die-cast aluminium enclosure | 295 x 250 x 156 |
| YGTH-GB-2000 | 400V, 2000W Gear tray in die-cast aluminium enclosure | 404 x 268 x 186.5 |



LED HIGHBAYS IP65

5 Year Warranty



Narrow Angle - Supply Voltage: 85-265VAC | Working Life: 50 000hrs | Power Factor: > 0.95 | Recommended Mounting Height +12m | Applicable for Workshops, Factories, Storage, Supermarkets, Shops

| Code | Watts | Lumens | Colour Temp. | Beam Angle | Dimensions | Weight |
|------------|-------|---------|--------------|------------|------------|--------|
| LQ-ILH-200 | 200W | 20000lm | 6000K | 60° | Ø367 x 459 | 11kg |
| LQ-ILH-300 | 300W | 30000lm | 6000K | 60° | Ø367 x 470 | 11,5kg |

- WW - 2700K
- CW - 4200K
- DL - 6000K



FLP



Explosion Proof Light - Supply Voltage: 85-265VAC | 120° Beam Angle.

| Code | * Add Watts to Code | Luminous Efficiency | Size (mm) | *Add Colour to Code |
|------------|----------------------|---------------------|------------|---------------------|
| SEM-HG-*-* | 50W, 70W, 100W, 120W | 100lm/W | Ø295 x 164 | WW / CW / DL |

- WW - 2700K
- CW - 4200K
- DL - 6000K



Weatherproof Light - Supply Voltage: 85-265VAC | 120° Beam Angle.

| Code | * Add Watts to Code | Luminous Efficiency | Size (mm) | *Add Colour to Code |
|-------------|----------------------|---------------------|------------|---------------------|
| JR-GK10-*-* | 50W, 70W, 100W, 120W | 100lm/W | Ø295 x 164 | WW / CW / DL |

3 Year Warranty

Please note that LED Head and Reflectors are to be ordered separately!

LED High Bays - Recommended Mounting Height 4-10m | Supply Volts: 100-240VAC | CRI: 75(cw), 80 (ww) Working Temp: -40-65°C | Aluminium Reflectors available in two Beam Angles | High Quality Meanwell Drivers



| Wattage | Lumen | LED Head | Reflector 120° | Reflector 45-60° | Weight Inc. Ref |
|---------|---------|----------------|----------------|------------------|-----------------|
| 50W | 4750lm | HB-LED-50W-* | HB-AL120-50W | HB-AL4560 | 4.1kg |
| 100W | 9500lm | HB-LED-100W-* | HB-AL120 | | 6.1kg |
| 120W | 11400lm | HB-LED-120W-* | HB-AL120L | HB-AL4560L | 6.1kg |
| 150W | 14250lm | HB-LED-150W-CW | | | 8.3kg |
| 200W | 19000lm | HB-LED-200W-* | | | 7.2kg |

*Add colour to code: ○ CW (Cool White) 4200K, ○ WW (Warm White) 3000K.

3 Year Warranty



High Power LED Highbays - Supply voltage: 85 - 265VAC | Colour Temp: 4000K | CRI > 80 | Working Temp: -25°C to +60°C | Bridgelux Chipset

| Code 45-60° Reflector | Code 120° Reflector | Watts | Lumens | Size |
|-----------------------|---------------------|-------|---------|------------|
| HB-L4560D-30W-CW | HB-L120D-30W-CW | 30W | 2850lm | Ø410 x 500 |
| HB-L4560D-50W-CW | HB-L120D-50W-CW | 50W | 4750lm | Ø410 x 500 |
| HB-L4560D-100W-CW | HB-L120D-100W-CW | 100W | 9500lm | Ø410 x 510 |
| HB-L4560D-150W-CW | HB-L120D-150W-CW | 150W | 14250lm | Ø480 x 620 |
| - | HB-L120D-200W-CW | 200W | 19000lm | Ø480 x 650 |

LED HIGHBAYS

3 Year Warranty

150 lm/w



UFO Type 120° Beam Angle - Supply Voltage: 100-265VAC | Working Conditions: -40°- 55°C | Working Life: 50 000hrs | CRI > 80 | Power Factor: > 0.95

| Code | Wattage | Lumens | Size (mm) |
|-------------|---------|---------|-----------|
| GY630-100-* | 100W | 15000lm | Ø247 x 90 |
| GY630-150-* | 150W | 22500lm | Ø256 x 90 |
| GY630-200-* | 200W | 30000lm | Ø270 x 95 |

*Add colour to code: ○ CW (Cool White) 4000-4200K or ○ DL (Daylight) 6000K

125 lm/w

5 Year Warranty



EMG

UFO Type 90° Beam Angle - Supply Voltage: 100-240VAC | Dimmable 1-10V | Working Conditions: -40°- 55°C | Working Life: 50 000hrs | Colour Temp: 6000K | CRI > 80 | Power Factor: > 0.95

| Code | Wattage | Lumens | Size (mm) |
|-----------|---------|---------|------------|
| GY530-120 | 120W | 15000lm | Ø366 x 194 |
| GY530-150 | 150W | 18500lm | Ø366 x 194 |
| GY530-200 | 200W | 24000lm | Ø366 x 194 |

Optional Accessories

| Code | Description |
|---------------|---------------------------------------------------------------------------------------------|
| HB-EMG-40-90M | Emergency backup power for 0-150W highbay 90min @ 30% Power See page ??? for more info |
| HB-EMG-60-90M | Emergency backup power for 200W highbay 90min @ 30% Power See page ??? for more info |

NEW

2 Year Warranty

120 lm/w



DOB LED Highbay - Supply Voltage: 220 -240VAC | Driver on board (DOB) | 120° Beam Angle | CRI 70 | Die-Cast Aluminium with Acrylic lens

| Code | Wattage | Lumens | Size (mm) |
|---------------|---------|---------|-----------|
| GY-DOB-100W-* | 100W | 12000lm | Ø230 x 33 |
| GY-DOB-150W-* | 150W | 18000lm | Ø290 x 33 |
| GY-DOB-200W-* | 200W | 24000lm | Ø314 x 33 |

*Add colour to code: ○ CW (Cool White) 4200K or ○ DL (Daylight) 6000K

150 lm/w

5 Year Warranty



60°/90° Lens



70° Reflector



60° Reflector



90° Reflector



EMG

Orion Highbay - Input Voltage: 220-240VAC | 150lm/W | Colour Temperature 5000K | 1 - 10V Dimmable | Supplied with 120° Lens, Interchangeable lenses available | Adaptable Reflectors Available

| Code | Wattage | Lumens | Size (mm) |
|--------------|---------|---------|------------|
| BT-ON100W-UV | 100W | 15000lm | Ø245 x 184 |
| BT-ON150W-UV | 150W | 22500lm | Ø280 x 202 |
| BT-ON200W-UV | 200W | 30000lm | Ø300 x 207 |

Optional Accessories

| Code | Description |
|---------------|---------------------------------------------------------------------------------------------|
| BT-ON-LENS-60 | 60° Fresnel Lens |
| BT-ON-LENS-90 | 90° Fresnel Lens |
| BT-ON-REF-60 | 60° Aluminium Reflector |
| BT-ON-REF-90 | 90° Aluminium Reflector |
| BT-ON-REF-70 | 70° Acrylic Reflector |
| HB-EMG-40-90M | Emergency backup power for 0-150W highbay 90min @ 30% Power See page ??? for more info |
| HB-EMG-60-90M | Emergency backup power for 200W highbay 90min @ 30% Power See page ??? for more info |

NEW

5 Year Warranty

150 lm/w



GY830-A-DL



EMG

Selectable Highbay - IP65 Supply Voltage: 100-277VAC | 90° Beam Angle | Colour Temperature: Selectable 3k, 4K, 5K | Power: Selectable 100,150, 200W | 0-10V Dimming Plug and Play Modules for added functions.

| Code | Wattage | Lumens | Size (mm) |
|--------------|--------------|---------|------------|
| GY830-PW-CCT | 100/150/200W | 190lm/w | Ø300 x 134 |

Accessories

| Code | Description |
|---------------|---------------------------------------------------------------------------------------------|
| GY830-SEN-PIR | Plug and Play PIR Sensor |
| GY830-SEN-M | Plug and Play Microwave Sensor |
| GY830-SEN-BT | Plug and Play TUYA Bluetooth Module |
| GY830-SEN-REM | Remote Control for GY830 |
| HB-EMG-40-90M | Emergency backup power for 0-150W highbay 90min @ 30% Power See page ??? for more info |
| HB-EMG-60-90M | Emergency backup power for 200W highbay 90min @ 30% Power See page ??? for more info |

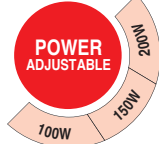

LED HIGHBAYS

5 Year Warranty

130 lm/w



High Power LED Highbay - IP65 | Input Voltage: 100-277VAC | Philips 3030 | 80° Beam Angle | Meanwell Driver | Operational Temperature: 40 ~ 60°C | Colour Temperature: 5500K | CRI > 80

| Code | Wattage | Lumens | Size (mm) |
|-------------|---------|----------|------------|
| BR-HBL-300W | 300W | 40 000lm | Ø460 x 262 |
| BR-HBL-400W | 400W | 54 000lm | Ø460 x 347 |
| BR-HBL-500W | 500W | 65 000lm | Ø460 x 315 |

NEW

5 Year Warranty

160 lm/w



Typhoon LED Highbay - IP65 | Supply voltage: 100-277VAC | 160lm/W | Colour Temp 6000K | Adjustable lens 60°, 85°, 110° | Supplied without microwave sensor

| Code | Wattage | Lumens | Size (mm) |
|----------------|---------|---------|--------------|
| YT-LEDH33-100W | 100W | 15500lm | Ø338 x 178mm |
| YT-LEDH33-150W | 150W | 23250lm | Ø338 x 178mm |
| YT-LEDH33-200W | 200W | 31000lm | Ø338 x 178mm |

Accessories

| Code | Description |
|----------------|------------------------------------------------------|
| YT-HD03R | Remote Control / Remote can set multiple Highbays |
| YT-LEDH33-MS | Microwave Sensor |
| YT-LEDH33-PCD | PC Diffuser Reflector with Mounting Accessories |
| YT-LEDH33-PCC | PC Bowl Cover for Diffuser with Mounting Accessories |
| YT-LEDH33-BR01 | Mounting Bracket for 100W, 150W & 200W |

YT-HD03R

YT-LEDH33-PCC

YT-LEDH33-BR01

YT-LEDH33-MS

YT-LEDH33-PCD

5 Year Warranty

130 lm/w



100W / 200W

2 x 200W

4 x 200W

YT-REF-100

Split Joint Module Highbay - IP65 | Input Voltage: 100 - 265VAC | Honeycomb Shape | 120° Beam Angle | Colour Temperature: 6000K | CRI > 80 | PF > 0.98

| Code | Wattage | Lumens | Size (mm) |
|----------------|-----------------|----------|-----------------|
| YT-LED-H27-100 | 100W | 13000lm | Ø200 x 232 |
| YT-LED-H27-200 | 200W | 26000lm | Ø200 x 248 |
| YT-LED-H27-400 | 2 x 200W (400W) | 52000lm | 401 x 200 x 248 |
| YT-LED-H27-800 | 4 x 200W (800W) | 104000lm | 521 x 521 x 248 |

Optional Accessories - Reflector

| Code | Description |
|------------|-------------------------------------------|
| YT-REF-100 | Optional 90° Reflector for YT-LED-H27-100 |
| YT-REF-200 | Optional 90° Reflector for YT-LED-H27-200 |

5 Year Warranty

130 lm/w



EMG





Food Processing Applications - IP66 | Input Voltage: 100 - 277VAC | 120° Beam Angle | Colour Temperature 6000K | CRI > 80 | PF > 0.9 | Suitable for cleaning with pressure water jet | Unique design prevents dust & moisture from collecting | Corrosion resistant | No Glass | No Exposed Screws

| Code | Wattage | Lumens | Size (mm) |
|--------------|---------|---------|------------|
| WD10-100W-DL | 100W | 13000lm | Ø489 x 200 |
| WD15-150W-DL | 150W | 19500lm | Ø489 x 200 |
| WD20-200W-DL | 200W | 26000lm | Ø489 x 200 |

Optional Accessories

| Code | Description |
|---------------|---------------------------------------------------------------------------------------------|
| HB-EMG-40-90M | Emergency backup power for 0-150W highbay 90min @ 30% Power See page ??? for more info |
| HB-EMG-60-90M | Emergency backup power for 200W highbay 90min @ 30% Power See page ??? for more info |

SHALLOW BOWL INDUCTION HIGH BAY LIGHT

| | | | | |
|-----------------------------------------------------------------------------------|--------------------------------------------------------------------------------------------------|---------------------------------------------------------------------------------------------------|-------------------------------------------------------------------------------------|--------------------|
| Supply Voltage: 180-260VAC 6000K |  c/w glass bowl |  c/w glass bowl | Accessories | |
| Code | GDD-N* | GDD-V* |  | GDD-BGLASS |
| *Add watts to code | 150W, 200W, 250W | 150W, 200W, 250W | Description | Spare glass bowl |
| Luminous Efficiency | 80lm/W | 80lm/W |  | GDD-BACR |
| Beam Type | Wide | Narrow | Description | Spare Acrylic bowl |
| Reflective Coating | Nano-coating | Vacuum Coating | | |
| Size | Power (W) | Ø (mm) | Code | GDD-BACR |
|  | 150 | Ø470 | | |
| | 200 | Ø506 | | |
| | 250 | Ø556 | | |
| | | H (mm) | | |
| | | 432 | | |
| | | 445 | | |
| | | 462 | | |

INDUCTION HIGH BAYS

Reflectors for Induction High Bays

Polycarbonate. Supplied c/w white collar



Reflectors for Induction High Bays - Aluminium



Control Gear IP43

Supply Voltage:
180-260VAC



| Size | Lamp Size | Reflector | Bowl Cover | Reflector | Bowl Cover | Reflector | Code | CHG-GB* |
|-------|-----------|-----------|------------|-----------|------------|-----------|--------------------|---------------------------------------------------|
| 410mm | 80 - 200W | PCR-410 | NBC114-2 | - | - | - | *Add power to code | 80W, 100W, 120W, 150W, 200W, 250W |
| 485mm | 80 - 200W | - | - | ALR-485 | RW-AL485 | - | Material | Die Cast Aluminium |
| 505mm | 80 - 250W | - | - | - | - | ALR-505SH | Description | Gear box with built in ballast for induction lamp |
| 570mm | 250W | PCR-570 | NBC114-4 | ALR-570 | RW-AL570 | - | | |

To put together a complete fitting order: 1x Reflector, 1x Control Gear, 1x Lamp

INDUCTION BALLASTS

Ballasts for Low Frequency Induction Lamps

PF: 0.99. Operating Temperature: -35°C to 50°C. Frequency: 230kHz ±30



| Code | Size L x W x H | Supply Volts |
|-------------|------------------|--------------|
| CH-WJZ-80W | 191 x 100 x 56mm | 180-260VAC |
| CH-WJZ-150W | 191 x 100 x 56mm | 180-260VAC |
| CH-WJZ-200W | 206 x 110 x 56mm | 180-260VAC |
| CH-WJZ-300W | 206 x 110 x 56mm | 180-260VAC |

INDUCTION LAMPS

Low-Frequency Induction Lamps - Supply volts 160-260VAC | PF: 0.98 | Quick starting | CRI: 80 | Ballast to be ordered separately

- WW - 2700K
- CW - 4000K
- DL - 6000K



| Ring | Rectangular | IN-AD | | | | |
|-------------------|------------------|-------------|------------------|------------|---------------|---------------------|
| Code ^A | Lamp Size | Code | Lamp Size | Lamp Power | Lumen | *Add colour to Code |
| CH-HX-80W* | 225 x 215 x 78mm | CH-JX-80W* | 300 x 142 x 78mm | 80W | 6000-6400lm | WW / CW / DL |
| CH-HX-100W* | 225 x 215 x 78mm | CH-JX-100W* | 300 x 142 x 78mm | 100W | 7500-8200lm | WW / CW / DL |
| CH-HX-120W* | 305 x 275 x 78mm | CH-JX-120W* | 370 x 142 x 78mm | 120W | 9225-9840lm | WW / CW / DL |
| CH-HX-150W* | 340 x 295 x 79mm | CH-JX-150W* | 410 x 142 x 78mm | 150W | 11475-12699lm | WW / CW |
| CH-HX-200W* | 355 x 315 x 89mm | CH-JX-200W* | 500 x 150 x 90mm | 200W | 15000-17000lm | WW / CW / DL |
| CH-HX-250W* | 420 x 395 x 90mm | CH-JX-250W* | 550 x 155 x 90mm | 250W | 18750-21250lm | WW / CW / DL |
| CH-HX-300W* | 430 x 400 x 90mm | CH-JX-300W* | 550 x 160 x 90mm | 300W | 22500-28050lm | WW / CW / DL |

^AIncludes IN-AD lampholder adaptor for use in high bay fittings.

HIGH BAY WITH CONTROL GEAR

Reflector to be ordered separately

High Pressure Sodium



Metal Halide



Mercury Vapour



| Power | HPS Code | Starting Current | Running Current | MH Code | Starting Current | Running Current | MV Code | Starting Current | Running Current |
|-------|------------|------------------|-----------------|-----------|------------------|-----------------|-----------|------------------|-----------------|
| 250W | HBB-250HPS | 2.10A | 1.42A | HBB-250MH | 3.00A | 1.35A | HBB-250MV | 2.60A | 1.35A |
| 400W | HBB-400HPS | 3.80A | 2.20A | HBB-400MH | 3.80A | 2.20A | HBB-400MV | 4.20A | 2.10A |

Polycarbonate Highbays



Supplied c/w white collar

Control Boxes for Polycarbonate Highbays



Aluminium Highbays



Control Boxes for Aluminium Highbays



| Size | Reflector Code | Bowl Cover Code | Code | GB-18 | GHK03 | GHK05 | Size | Reflector Code | Bowl Cover Code | GHK03 |
|-------|----------------|-----------------|-----------|-------------|--------------------|--------------------|-------|----------------|-----------------|--------------------|
| 410mm | PCR-410 | NBC114-2 | Size(mm) | 240x190x160 | 260x270x255 | 225x225x170 | 410mm | ALR-410 | - | 260x270x255 |
| 485mm | - | - | Material | Sheet Steel | Die-cast Aluminium | Die-cast Aluminium | 485mm | ALR-485 | RW-AL485 | Die-cast Aluminium |
| 570mm | PCR-570 | NBC114-4 | IP-Rating | IP20 | IP43 | IP20 | 570mm | ALR-570 | RW-AL570 | IP43 |

HIGH BAY WITHOUT CONTROL GEAR



Bowl



| Code | NB8012 | DH-6389 | DH-6387 |
|------------------|-----------|--------------|--------------|
| Type | Aluminium | PC | PC |
| Lampholder | E40 | E40 | E40 |
| Size | 480mm | Ø340 x 330mm | Ø420 x 400mm |
| Bowl Code | RW-AL480 | - | Included |
| Material of Bowl | Glass | - | - |

For lamps see page 25-26.
For metal halide ballasts see page 159-160.



NB150GB

c/w 1m chain



c/w 1m chain



c/w 1m chain and glass bowl



| Code | NB1065-310 | NB1065-365 | NB1128-310-AL | NB1128-410-AL | NB8016-325 | NB8016-430 |
|---------------|--------------|--------------|---------------|---------------|--------------|--------------|
| Type | PC | PC | Aluminium | Aluminium | Aluminium | Aluminium |
| Lampholder | E27 | E27 | E27 | E27 | E27 | E40 |
| Size | 310Ø x 180mm | 365Ø x 240mm | 310Ø x 125mm | 410Ø x 265mm | 325Ø x 375mm | 430Ø x 375mm |
| Code for Bowl | NBC1065 | - | NBC1128 | NBC1128-410 | Included | Included |

LED T-BAY / HIGHBAY

**5 Year
Warranty**

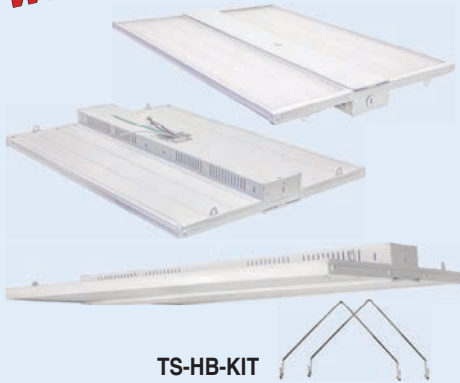

TS-HB-KIT

Input Voltage: 120-277VAC | 120° Viewing Angle | 1-10V Dimming | Colour Temperature 5000K | c/w Mounting Kit | Applications: Industrial

| Code | Wattage | Lumens | Size (mm) |
|--------------|---------|---------|-----------------|
| TS-FHB1-110W | 110W | 14300lm | 604 x 244 x 50 |
| TS-FHB2-165W | 165W | 21450lm | 604 x 320 x 50 |
| TS-FHB3-220W | 220W | 28600lm | 604 x 440 x 50 |
| TS-FHB5-165W | 165W | 21450lm | 1168 x 320 x 50 |
| TS-FHB5-220W | 220W | 28600lm | 1168 x 320 x 50 |
| TS-FHB5-300W | 300W | 39000lm | 1168 x 320 x 50 |

Additional Accessories

| Code | Description |
|-----------|-------------------------------------|
| TS-HB-KIT | Chain Mounting Kit (Chain Excluded) |

T-BAY FLUORESCENT FITTINGS

T5 Louvred High Bay Fittings

- With Electronic Ballast
- Steel Grey Powder Coated
- For food industry applications use in combination with tube sleeves



TB-428

TB-280

| Code 2 Lamp | Code 4 Lamp | Size (mm) L x W x H | Wattage per Lamp | Lamp Type G5 |
|----------------|----------------|------------------------|---------------------|-----------------|
| TB-235 | - | 1493 x 291 x 48 | 35W (5FT) | FLT5-35W |
| TB-254 | - | 1193 x 291 x 48 | 54W (4FT) | FLT5-54W |
| TB-280 | - | 1493 x 291 x 48 | 80W (5FT) | FLT5-80W |
| - | TB-454 | 1193 x 518 x 48 | 54W (4FT) | FLT5-54W |
| - | TB-480 | 1493 x 518 x 48 | 80W (5FT) | FLT5-80W |

Lamps excluded. For lamps see page 19

Accessories

| Code | Description |
|---------------|-----------------------------------------------|
| 5L2-35E | Electronic Ballast for 2 x 35W |
| 5IC2-54E | Electronic Ballast for 2 x 54W |
| SI-280 | Electronic Ballast for 2 x 80W |
| TB-1493-RAIL | 2 x Diffuser Rail 1493 x 31 x 7mm |
| TB-1493-DIFF4 | Transparent Acrylic Diffuser 1493 x 498 x 3mm |

Mounting Bracket Included



Compact T5 Louvred High Bay Fittings

- With Electronic Ballast
- White Powder Coated
- For food industry applications use in combination with tube sleeves



HB-L628A

HB-L428A

| Code 4 Lamp | Code 6 Lamp | Size (mm) L x W x H | Wattage per Lamp | Lamp Type G5 |
|----------------|----------------|------------------------|---------------------|-----------------|
| HB-L428A | - | 1170 x 332 x 76 | 28W (4FT) | FLT5-28W |
| HB-L435A | - | 1470 x 332 x 76 | 35W (5FT) | FLT5-35W |
| HB-L454A | - | 1170 x 332 x 76 | 54W (4FT) | FLT5-54W |
| HB-L480A | - | 1470 x 332 x 76 | 80W (5FT) | FLT5-80W |
| - | HB-L628A | 1170 x 502 x 76 | 28W (4FT) | FLT5-28W |
| - | HB-L654A | 1170 x 502 x 76 | 54W (4FT) | FLT5-54W |
| - | HB-L635A | 1470 x 502 x 76 | 35W (5FT) | FLT5-35W |
| - | HB-L680A | 1470 x 502 x 76 | 80W (5FT) | FLT5-80W |

Lamps excluded. For lamps see page 19.

Accessories

| Code | Description |
|----------|--------------------------------|
| 5L2-28E | Electronic Ballast for 2 x 28W |
| 5L2-35E | Electronic Ballast for 2 x 35W |
| 5IC2-54E | Electronic Ballast for 2 x 54W |
| SI-280 | Electronic Ballast for 2 x 80W |



LED LINEAR HIGHBAYS

**5 Year
Warranty**

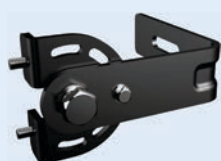

BR-HBL-BRKT



BR-HBL-SEN

Industrial Bay - IP65

Input Voltage: 240VAC | Phillips SMD LEDs | Operating Temperature: -20°~ 50° | Meanwell Driver | Colour Temp: 5500K | 1-10V Dimmable | Supplied with Suspension Kit and Mounting Clips

| Code | Wattage | Lumens | Beam Angle | Dimensions |
|-----------------|---------|---------|------------|-----------------|
| LBL-50W-60X100 | 50W | 5000lm | 60° x 100° | 341 x 135 x 84 |
| LBL-100W-60X100 | 100W | 10000lm | 60° x 100° | 631 x 135 x 84 |
| LBL-150W-30X70 | 150W | 19500lm | 30° x 70° | 718 x 137 x 102 |
| LBL-200W-30X70 | 200W | 18000lm | 30° x 70° | 1217 x 135 x 84 |

Additional Accessories

| Code | Description |
|-------------|-----------------------------------------------|
| BR-HBL-SEN | Radar Occupancy Sensor 360°, 15m Max Height |
| BR-HBL-BRKT | Mounting Bracket for wall or ceiling mounting |

NEW **5 Year
Warranty**

**140
lm/w**



Linear Highbay - IP66

Input Voltage 85-265VAC | 140lm/W | 5500K | 1-10V Dimmable | 240° Beam Angle | Frosted Diffuser | Applications: Airport, Parking Garages, Industrial Warehouses, Gymnasiums

| Code | Wattage | Lumens | Size (mm) |
|-------------|---------|---------|-----------------|
| IK-LHB-80W | 80W | 11200lm | 600 x 154 x 70 |
| IK-LHB-150W | 150W | 21000lm | 1200 x 154 x 70 |
| IK-LHB-200W | 200W | 28000lm | 1500 x 154 x 70 |
| IK-LHB-240W | 240W | 33600lm | 1500 x 154 x 70 |

LED HIGHBAY/LOWBAY IP65

Supply Voltage:

90-246VAC

- Meanwell Drivers
- Bridge Lux LEDs
- Colour Temp: 3000K



| Code | LGCD60WD-WW | HLB00202-* | LGCD210WE-WW |
|-----------------------|-----------------|-------------------|-----------------|
| Power | 60 x 1W (70W) | 58 x 1.73W (100W) | 210W |
| Luminous Flux | 7200lm | 2622lm | 23100lm |
| Equivalent Brightness | 150W | 600W | 700W |
| Size (mm) | 346 x 320 x 174 | 298D x Ø378 | 700 x 395 x 190 |

*Add colour to code: ○ CW (Cool White 5000k-5500k), ○ WW (Warm White 2700-3000k)

LED GAS STATION CANOPY LIGHT IP65

5 Year Warranty



CYZ-100-R - Recessed



CYZ-ECO-100-S - Surface

Standard - Input Voltage: 100-277VAC | Colour Temp. 6000K | Material: Aluminium Alloy | High Quality Chipset for Superior Light Output | Available as Surface or Recess Mount

| Code | Wattage | Lumens | Size (mm) | Cut-out Size (mm) |
|-----------|---------|---------|-----------------|-------------------|
| CYZ-100-R | 100W | 11000lm | 420 x 420 x 160 | 360 x 360 |
| CYZ-100-S | 100W | 11000lm | 420 x 420 x 160 | - |

Economy - Input Voltage: 100-277VAC | Colour Temp. 6000K | Material: Aluminium Alloy | System designed to be more affordable | Available as Surface or Recess Mount

| Code | Wattage | Lumens | Size (mm) | Cut-out Size (mm) |
|---------------|---------|---------|-----------------|-------------------|
| CYZ-ECO-100-R | 100W | 11000lm | 350 x 248 x 115 | 316 x 200 |
| CYZ-ECO-100-S | 100W | 11000lm | 380 x 380 x 70 | - |

Power and CCT Adjustable - Input Voltage: 100-277VAC | Surge Protection: 6kV Line to Line, 10kV Line to Earth | Control: 0-10V, Dali, Plug and Play Microwave or PIR Sensor | Power Adjustable: 120W, 90W, 60W, 36W | Colour Temp. Adjustable: 3000K, 4000K, 5000K | 120° Beam Angle | Die-cast Aluminium and Tempered Glass

| Code | Wattage | Lumens | Size (mm) | Cut-out Size (mm) |
|----------------|----------|---------|----------------|-------------------|
| CP01-120-P-CCT | Max 120W | 150lm/W | 370 x 369 x 65 | - |

Accessories

| Code | Description |
|-----------|------------------------------------------------|
| ANT-6-4T | PIR Sensor |
| ANT-5-4T | Microwave Sensor |
| RC-100 | Remote Control for PIR Sensor or Motion Sensor |
| BC-C01-02 | Surface Mount Adaptor |
| BC-C01-01 | G314 Conduit Mounting Adaptor |

NEW 5 Year Warranty

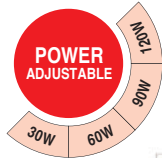

CP01-120-P-3-T

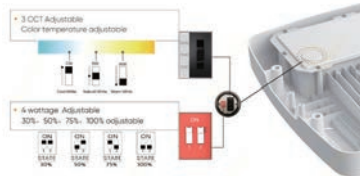

LED PARKING BAY LIGHT IP65

5 Year Warranty



Round Standard - Input Voltage: 230VAC | 160° Beam Angle | Colour Temp. 5000K | CRI > 80 | 1-10V Dimmable

| Code | Wattage | Lumens | Size (mm) |
|-----------|---------|--------|------------|
| BT-ST-60W | 60W | 8100lm | Ø290 x 114 |

Round with Built-in Sensor - Input Voltage: 230VAC | 160° Beam Angle | Colour Temp. 5000K | CRI > 80 | 1-10V Dimmable

| Code | Wattage | Lumens | Size (mm) |
|-----------|---------|--------|------------|
| BT-VT-60W | 60W | 8100lm | Ø290 x 114 |

Accessories

| Code | Description |
|-----------|---------------------------------------|
| MC612V-IR | Remote Control to Configure BT-VT-60W |

Square Standard - Input Voltage: 100-277VAC | Colour Temp. 6000K | Die-Cast Alu+PC

| Code | Wattage | Lumens | Size (mm) |
|------------|---------|--------|----------------|
| TS-GCP0840 | 40W | 4800lm | 255 x 255 x 86 |
| TS-GCP1070 | 70W | 8400lm | 255 x 255 x 86 |

Industrial

LIGHTING

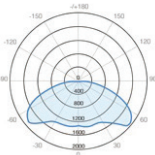

160°



BT-ST-60W / BT-VT-60W



MC612V-IR



TS-GCP0840

LOW BAY FITTING E40 BASE

Input Voltage: 230VAC | Fitting size: 715 x 320 x 210mm | Lamp not included

| Code | Wattage | Lamp Code | Gear |
|----------|---------|------------|-------------------------|
| LB-250MH | 250W | MT-250-E40 | Metal Halide low bay |
| LB-400MH | 400W | MT-400-E40 | Metal Halide low bay |
| LB-1001 | - | - | Empty (no control gear) |

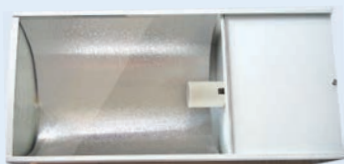

LED STREET LAMP - RETROFIT

- WW - 2700K
- CW - 4200K
- DL - 6000K



NEW
NEW

Input Voltage: 230V | Ideal for Retrofit Installations

| Code | Wattage | Lumens | Base | Size (mm) | *Colour Temp |
|-------------|---------|--------|------|------------|--------------|
| SP90-* | 28W | 2100lm | E40 | Ø90 x 275L | WW / DL |
| TK-VCL-36-* | 36W | 4680lm | E27 | Ø98 x 245 | CW / DL |
| TK-VCL-54-* | 54W | 7020lm | E40 | Ø98 x 245 | CW / DL |

LED STREET LIGHTS

- DL - 6000K

NEW 3 Year Warranty



Eco 1 LED Street Light IP66 - Input Voltage: 230VAC | Beam Angle: 70° x 140° | CRI > 70

Die-Cast Aluminum

| Code | Wattage | Lumens | Size (mm) | Colour Temp |
|-----------------|---------|---------|----------------|-------------|
| RW-ST-FH-50-DL | 50W | 4500lm | 380 x 160 x 70 | DL |
| RW-ST-FH-100-DL | 100W | 9000lm | 505 x 205 x 83 | DL |
| RW-ST-FH-150-DL | 150W | 12000lm | 600 x 260 x 83 | DL |

- DL - 6000K

NEW 3 Year Warranty



Eco 2 LED Street Light IP66 - Input Voltage: 100-300VAC | Beam Angle: 120° | CRI > 80

Die-Cast Aluminum + Tempered Glass

| Code | Wattage | Lumens | Size (mm) | Colour Temp |
|----------------|---------|---------|----------------|-------------|
| SL-016-20W-DL | 20W | 2200lm | 300 x 110 x 63 | DL |
| SL-016-30W-DL | 30W | 3300lm | 300 x 110 x 63 | DL |
| SL-016-50W-DL | 50W | 5500lm | 400 x 150 x 78 | DL |
| SL-016-100W-DL | 100W | 11000lm | 500 x 180 x 78 | DL |
| SL-016-150W-DL | 150W | 16500lm | 500 x 180 x 78 | DL |
| SL-016-200W-DL | 200W | 22000lm | 500 x 180 x 78 | DL |

- CW - 4200K

3 Year Warranty



Slim - Eco LED Street Light IP65 - Input Voltage: 85 - 265VAC | 110lm/W

| Code | Wattage | Lumens | Size (mm) | Colour Temp |
|-----------|---------|---------|-----------------|-------------|
| LL-SL-60 | 60W | 6600lm | 475 x 215 x 145 | CW |
| LL-SL-120 | 120W | 13200lm | 685 x 270 x 145 | CW |

- DL - 6000K

3 Year Warranty



Cobra LED Street Light IP65 - Input Voltage: 90-305VAC | High Power Single LED Chip |

Die-Cast Aluminium Body

| Code | Wattage | Lumens | Size (mm) | Colour Temp |
|-----------|---------|---------|----------------|-------------|
| LU793-60 | 60W | 5700lm | 640 x 250 x 80 | DL |
| LU793-100 | 100W | 9500lm | 720 x 280 x 95 | DL |
| LU793-120 | 120W | 11400lm | 850 x 315 x 95 | DL |
| LU793-150 | 150W | 14200lm | 850 x 315 x 95 | DL |
| LU793-200 | 200W | 19000lm | 850 x 315 x 95 | DL |

LED STREET LIGHTS IP65

○ DL - 6000K

5 Year Warranty

Module LED Street Light - Input Voltage: 230VAC | Type III Beam Angle (85 x 135°)



| Code | Wattage | Lumens | Size (mm) | Colour Temp |
|------------|---------|---------|-----------------|-------------|
| YR-ST-50W | 50W | 6000lm | 373 x 300 x 90 | DL |
| YR-ST-100W | 100W | 12000lm | 473 x 347 x 147 | DL |
| YR-ST-150W | 150W | 18000lm | 529 x 600 x 90 | DL |
| YR-ST-200W | 200W | 24000lm | 607 x 300 x 90 | DL |
| YR-ST-240W | 240W | 28800lm | 685 x 300 x 90 | DL |
| YR-ST-300W | 300W | 36000lm | 763 x 300 x 90 | DL |

LED STREET LIGHTS IP65

5 Year Warranty

○ DL - 6000K

Elegant LED Street Light - Input Voltage: 100-265VAC | High Lumen Output > 120lm/W | Installed with Knife Switch to cut power when body is opened | Adjustable Spigot with bottom & side entry adaptor | Die-Cast Aluminium Body

Knife Switch to cut power when body is opened



| Code | Wattage | Lumens | Size (mm) | Colour Temp |
|-------------|---------|---------|-----------------|-------------|
| LEDL19-60W | 60W | 7200lm | 640 x 265 x 110 | DL |
| LEDL19-80W | 80W | 9600lm | 640 x 265 x 110 | DL |
| LEDL19-100W | 100W | 12000lm | 700 x 305 x 120 | DL |
| LEDL19-120W | 120W | 14400lm | 700 x 305 x 120 | DL |

LED PARKING LOT LIGHT IP65

5 Year Warranty

Input Voltage: 100-277VAC | 120lm/W | Colour Temperature: 5700K | Light Distribution "Type IV" | Supplied with Type A Slip Fitter | Suitable for Parking Lots, Residential areas, Landscapes, Roads and Architecture



| Code | Wattage | Lumens | Size (mm) |
|--------------|---------|---------|----------------|
| YR-PL345-100 | 100W | 12000lm | 367 x 348 x 68 |
| YR-PL345-150 | 150W | 18000lm | 367 x 348 x 68 |
| YR-PL670-200 | 200W | 24000lm | 434 x 353 x 75 |
| YR-PL670-300 | 300W | 36000lm | 555 x 348 x 78 |

Mounting Brackets

| Code | Description |
|---------|------------------------------------------------------------|
| YR-PL-1 | Type A (Slip Fitter) |
| YR-PL-2 | Type B (Square/Round Pole Mount with Slip-Fitter Function) |
| YR-PL-3 | Type C (Square/Round Pole Mount) |
| YR-PL-4 | Type D (Trunnion) |

LED STREET LIGHTS IP65

5 Year Warranty

○ DL - 6000K



Elegant with 7 Pin Nema Socket LED Street Light - Input Voltage: 100-265VAC | Beam Angle: 80° x 135° | High Lumen Output > 120lm/W | Inventronics 0-10V Dimmable Driver | 7 Pin Nema Socket | Die Cast Aluminium | Installed with Knife Switch to cut power when body is opened | Adjustable Spigot with bottom & side entry adaptor.

| Code | Wattage | Lumens | Size (mm) | Colour Temp |
|-------------|---------|---------|-----------------|-------------|
| LED-N19-60 | 60W | 6000lm | 616 x 259 x 186 | DL |
| LED-N19-80 | 80W | 8000lm | 616 x 259 x 186 | DL |
| LED-N19-100 | 100W | 10000lm | 676 x 303 x 186 | DL |
| LED-N19-120 | 120W | 12000lm | 676 x 303 x 186 | DL |



Photo Controller:

Rated Voltage: 110-277VAC | Typical on/off delay: 50lux | Typical Time delay: 10sec | Ambient Temp: 40 ~ 170°C | Size: Ø84 x 86mm | **IP65**

| Code | JL-241C | JL-242C | JL-243C |
|-------------------------|---------|---------|---------|
| Constant on/off Dimming | • | • | • |
| Midnight Dimming | X | • | • |
| LED Decay Compensation | X | X | • |

Constant On/Off Dimming: Constant lighting level, in accordance with the natural sunlight level detected. When the natural lighting is higher than 110% of the rated level, power will be disconnected to increase power saving.

Midnight Dimming: Output lowered to a customized percentage to save power after midnight until dawn, as well as reduce light pollution to environment.

LED Decay Compensation: Output partially reserved for compensating decay. It will extend the work life of a LED fixture significantly.

Knife Switch to cut power when body is opened

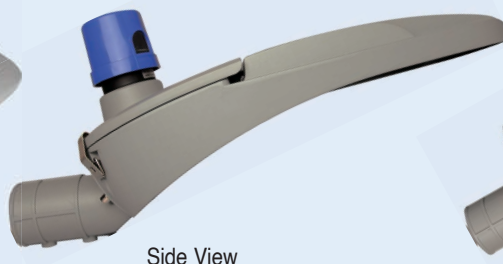
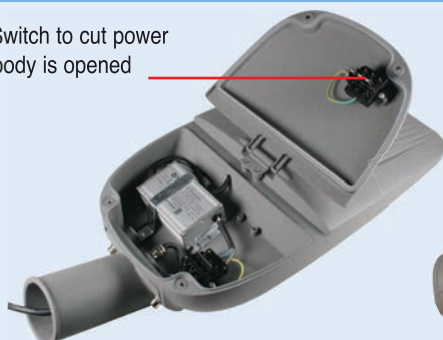

Side View

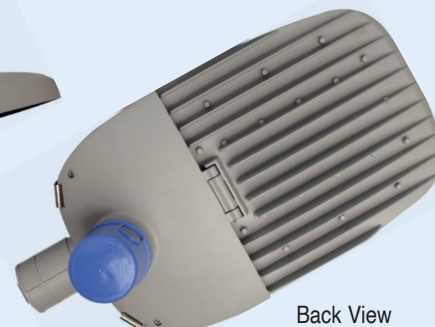

Back View

CREE

○ DL - 6000K

3 Year Warranty

Flux LED Street Light - Input Voltage: 220-240VAC | Die-Cast Aluminium Body

| Code | Wattage | Lumens | Size (mm) | Colour Temp |
|-----------------|---------|---------|-----------------|-------------|
| ZY-6009-LED-40 | 40W | 4000lm | 565 x 270 x 145 | DL |
| ZY-6009-LED-60 | 60W | 6000lm | 640 x 270 x 160 | DL |
| ZY-6009-LED-80 | 80W | 8000lm | 755 x 300 x 215 | DL |
| ZY-6009-LED-120 | 120W | 12000lm | 862 x 360 x 231 | DL |



40W & 60W

80W & 120W

HID STREET LIGHTING IP65

Flux HID Street Light Input Voltage: 220-240VAC | Die-Cast Aluminium Body | Tempered Glass Diffuser | Lamps Excluded - For Lamps see page 25-26

| Code | Wattage | Lamp Holder | Pole Entry | Size (mm) |
|---------------|---------|-------------|---------------|-----------------|
| ZY-6009-70-* | 70W | E27 | Side & Bottom | 565 x 220 x 145 |
| ZY-6009-150-* | 150W | E27 | Side & Bottom | 640 x 270 x 160 |
| ZY-6009-250-* | 250W | E40 | Side & Bottom | 755 x 300 x 215 |
| ZY-6009-400-* | 400W | E40 | Side & Bottom | 862 x 358 x 215 |



70W, 150W, 250W



400W

*Add type of Control Gear required to code: **MH** (Metal Halide), **HPS** (High Pressure Sodium), **EMPTY** (No Control Gear)

HID STREET LIGHTING



Lamp Excluded-
For Lamps see Page 25-26

Path Finder HID - Input Voltage: 230VAC | SANS 475, SANS 60598-2-3 | UV stabilised polymer body, grey in colour | High impact UV stabilised clear acrylic lens | **IP54** Gear compartment, **IP65** Lamp compartment | Side Entry

| Code | Wattage | Lamp Type | Ignitor | Lamp Holder | Size (mm) |
|--------------|---------|---------------------------|---------|-------------|-----------------|
| PATH-70-MH | 70W | MH & HPS | Yes | E27 | 591 x 238 x 196 |
| PATH-70-HPS | 70W | HPS with Internal Ignitor | No | E27 | 591 x 238 x 196 |
| PATH-100-MH | 100W | MH & HPS | Yes | E27 | 591 x 238 x 196 |
| PATH-100-HPS | 100W | MH & HPS | Yes | E40 | 591 x 238 x 196 |
| PATH-150-MH | 150W | MH & HPS | Yes | E27 | 591 x 238 x 196 |
| PATH-150-HPS | 150W | HPS | Yes | E27 | 591 x 238 x 196 |
| PATH-EMPTY | EMPTY | - | No | E27 | 591 x 238 x 196 |

*Add type of Control Gear required to code: **MH** (Metal Halide), **HPS** (High Pressure Sodium), **EMPTY** (No Control Gear)



STN007

ST9012-*

Optic HID - Input Voltage: 220-240VAC | Die-Cast Aluminium Body | Glass Diffuser | Lamps Excluded | **IP65**

| Code | Wattage | Lamp Holder | Pole Entry | Size (mm) |
|----------|---------|-------------|------------|--------------------|
| STN007 | 250W | E40 | Side | 587L x 288W x 204H |
| ST9012-* | 250W | E40 | Side | 660L x 300W x 190H |

STN007 For use with LED Lamp. *Add type of Control Gear required to code: **MH** (Metal Halide), **HPS** (High Pressure Sodium), **EMPTY** (No Control Gear)

PL STREET LIGHT



Lamp Excluded-
For Lamps see Page 18-19

Path Finder PL - Input Voltage: 230VAC | SANS 475, SANS 60598-2-3 | UV stabilised polymer body, grey in colour | High impact UV stabilised clear acrylic lens | **IP54** Gear compartment, **IP65** Lamp compartment

| Code | Wattage | Lamp Holder | Pole Entry | Size (mm) |
|----------|---------|-------------|------------|---------------------|
| PATH-218 | 2 x 18W | PLCE | Side | 591.5 x 238.8 x 196 |
| PATH-226 | 2 x 26W | PLCE | Side | 591.5 x 238.8 x 196 |

EMPTY STREET LIGHT FITTING **IP65**



SFL-1001 & SFL-1001-P

SFL-1002 & SFL-1002-P

Photocell included with
SFL-1001-P / SFL-1002-P

Input Voltage: 220-240VAC | Complete with 15° Mounting Bracket | E27 Lamp Holder | Polycarb Body | Polycarb Diffuser | Lamps Excluded

| Code | Wattage | Pole Entry | Size (mm) |
|--------------------------------|-------------|------------|--------------------|
| Standard | | | |
| SFL-1001 | 1 x 45W Max | Side | 590L x 170W x 150H |
| SFL-1002 | 2 x 45W Max | Side | 590L x 250W x 170H |
| Complete with Photocell | | | |
| SFL-1001-P | 1 x 45W Max | Side | 590L x 170W x 150H |
| SFL-1002-P | 2 x 45W Max | Side | 590L x 250W x 170H |

Input Voltage: 230VAC | Complete with Mounting Arm and Day/Light Switch | E27 Lamp Holder | Die-Cast Aluminium Body | PS Diffuser | Lamps Excluded

| Code | Wattage | Pole Entry | Size (mm) |
|----------|---------|------------|-------------|
| SFL-3001 | 60W Max | Side | Ø300 x 470H |

INDUCTION STREET LIGHTS **IP65**



CHL-005*

JRD-DP-LD2001-*

JRD-DP-LD2002-*

Input Voltage: 230VAC | Colour Temperature: 5000K | Lamp Excluded - For Lamps see Page 39

| Code | *Add Wattage to Code | Lumen / Wattage | Size (mm) |
|-----------------|----------------------|-----------------|------------------|
| CHL-005-* | 80W, 100W, 120W | 80lm | 1000 x 405 x 210 |
| JRD-DP-LD2001-* | 80W, 100W, 120W | 80lm | 810 x 340 x 250 |
| JRD-DP-LD2002-* | 80W, 100W, 120W | 80lm | 960 x 410 x 200 |

LED INDUSTRIAL BULKHEADS IP65

Die-cast Aluminium Base | Glass Diffuser with Stainless Steel Clips | CRI > 80 | Colour Temp. 6000K
External Driver - 5 Year Warranty



IBG-LED-30W

IBG-LED-30W-PC

| Code | Input Voltage | Wattage | Lumens | Size (mm) |
|---------------|---------------|---------|--------|-----------------|
| IBG-LED-30W* | 85-265V | 30W | 3000lm | 418 x 314 x 203 |
| IBG-LED-60W* | 85-265V | 60W | 6000lm | 418 x 314 x 203 |
| IBG-LED-100W* | 85-265V | 100W | 9000lm | 418 x 314 x 203 |

DOB: Driver on Board - 2 Year Warranty

| Code | Input Voltage | Wattage | Lumens | Size (mm) |
|-------------------|---------------|---------|--------|-----------------|
| IBG-LED-30W-DOB* | 220-240V | 30W | 3000lm | 418 x 314 x 203 |
| IBG-LED-60W-DOB* | 220-240V | 60W | 6000lm | 418 x 314 x 203 |
| IBG-LED-100W-DOB* | 220-240V | 100W | 9000lm | 418 x 314 x 203 |

* For Polycarbonate Lens, add -PC to code

LED RETROFIT KIT FOR INDUSTRIAL BULKHEADS

IBS & EL-616 Retrofit Kit - CRI>80 | 6000K | Aluminium Tray designed to dissipate heat efficiently
External Driver - 5 Year Warranty

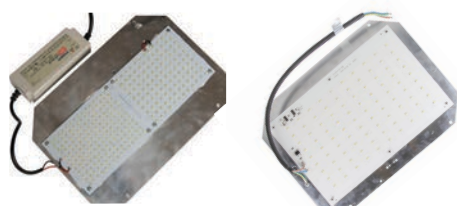

IBG-LEDRRK

IBG-LEDRRK-DOB

| Code | Input Voltage | Wattage | Lumens | Size (mm) |
|-----------------|---------------|---------|--------|-----------|
| IBG-LEDRRK-30W | 85-265V | 30W | 3000lm | 330 x 240 |
| IBG-LEDRRK-60W | 85-265V | 60W | 6000lm | 330 x 240 |
| IBG-LEDRRK-100W | 85-265V | 100W | 9000lm | 330 x 240 |

DOB: Driver on Board - 2 Year Warranty

| Code | Input Voltage | Wattage | Lumens | Size (mm) |
|---------------------|---------------|---------|--------|-----------------|
| IBG-LEDRRK-30W-DOB | 220-240V | 30W | 3000lm | 418 x 314 x 203 |
| IBG-LEDRRK-60W-DOB | 220-240V | 60W | 6000lm | 418 x 314 x 203 |
| IBG-LEDRRK-100W-DOB | 220-240V | 100W | 9000lm | 418 x 314 x 203 |

NEW



B40-LEDRRK-DOB

LASCON B40 Retrofit Kit - CRI>80 | 6000K | Aluminium Tray designed to dissipate heat efficiently
DOB: Driver on Board - 2 Year Warranty

| Code | Input Voltage | Wattage | Lumens | Size (mm) |
|---------------------|---------------|---------|--------|-----------|
| B40-LEDRRK-60W-DOB | 220-240V | 60W | 6000lm | 290 x 240 |
| B40-LEDRRK-100W-DOB | 220-240V | 100W | 9000lm | 290 x 240 |

LED WALL PACK IP65

Supply Voltage: 90-240V | Die-Cast Aluminium | Colour Temp: 6000K



LS-WP

RSWP-*-B

RSWP-*-C

| Code | Wattage | Lumens | Size (mm) |
|------------|---------|--------|-----------------|
| LS-WP30W | 30W | 2100lm | 366 x 185 x 233 |
| LS-WP60W | 60W | 4200lm | 366 x 185 x 233 |
| RSWP-30W-B | 30W | 2100lm | 287 x 272 x 188 |
| RSWP-60W-B | 60W | 4200lm | 287 x 272 x 188 |
| RSWP-30W-C | 30W | 2100lm | 264 x 308 x 182 |
| RSWP-60W-C | 60W | 4200lm | 264 x 308 x 182 |

INDUSTRIAL BULKHEADS - INDUCTION

Industrial Bulkheads - Input Voltage: 230VAC



JRD-BG9012-40W

JRD-BG9013-40W

EAL-BM

| Code | Wattage | Lumens | Size (mm) |
|--------------------------------------------------------------------------|---------|--------|-----------------|
| Induction - IP65 | | | |
| JRD-BG9012-40W | 40W | 3200lm | 275 x 270 x 190 |
| JRD-BG9013-40W | 40W | 3200lm | 288 x 308 x 180 |
| Induction - IP66 - Glass fill Nylon Base Polycarbonate Diffuser | | | |
| EAL-BM-80W | 80W | 6400lm | 320 x 420 x 180 |
| EAL-BM-100W | 100W | 8000lm | 320 x 420 x 180 |

INDUSTRIAL BULKHEADS - ENERGY SAVING



BK6009

Industrial Bulkheads - IP55 - Input Voltage: 230VAC | Electronic Ballast | Lamps Included | Die-Cast Aluminium body

| Code | Spare Lamp | Wattage / Lamp | Lumens | Size (mm) |
|-----------|------------|----------------|--------|-----------------|
| BK6009-26 | PLC-26-CW | 2 x 26W | 3400lm | 260 x 300 x 180 |
| BK6009-42 | PLCE-42-CW | 2 x 42W | 3500lm | 260 x 300 x 180 |

INDUSTRIAL BULKHEADS - HID

Lamp to be ordered separately.



IBPC

H.P.S. (High Pressure Sodium)
M.H. (Metal Halide)
M.V. (Mercury Vapour)

Industrial Bulkheads IP44 - 230VAC, Size: 310 x 258 x 225(D)mm, Polycarbonate Diffuser

| Watts | Code | | | | | | Lamp Holder |
|-------------------------------------------------------------------------------------------|----------------|------------|---------------------------|---------|------------|--------|-------------|
| | H.P.S. | Lamp | M.H. | Lamp | M.V. | Lamp | |
| 70W | IBPC-70IHPS | SD-70I | IBPC-70MH | MTE-70 | - | - | E27 |
| 125W | - | - | - | - | IBPC-125MV | QE-125 | E27 |
| 150W | IBPC-150HPS/MH | SD-150-E27 | IBPC-150HPS/MH | MTE-150 | - | - | E27 |
| Energy Saving Fittings - Excluding Lamps. Fitted Polycarbon diffuser and die-cast. | | | | | | | |
| 2 x 18W | IBPC-218 | PLC-18 | | | | | BCF-G24d2 |
| 2 x 26W | IBPC-226 | PLC-26 | | | | | BCF-G24d3 |
| 2 x 42 | IBPC-242 | PLCE-42 | | | | | BCF-G24q4 |
| | NB1269 | - | Empty Body c/w Lampholder | | | | E27 |

Lamp to be ordered separately.



IBG

H.P.S. (High Pressure Sodium)
M.H. (Metal Halide)
M.V. (Mercury Vapour)

Industrial Bulkheads IP65 - 230VAC, Size: 418 x 314 x 203(D)mm Glass Diffuser with stainless steel clips.

Die-cast aluminium base.

| Watts | Code | | | | | | Lamp Holder |
|-------|---------------|--------|---------------|---------|------|------|-------------|
| | H.P.S. | Lamp | M.H. | Lamp | M.V. | Lamp | |
| 70W | IBG-70IHPS | SD-70I | - | - | - | - | E27 |
| 150W | IBG-150HPS/MH | SD-150 | IBG-150HPS/MH | MTE-150 | - | - | E27 |

INDUSTRIAL BULKHEADS - EMPTY



BK6009

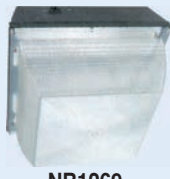

NB1269



EL-616

Industrial Bulkheads - Input Voltage: 230VAC I

E27 Lamp Holder I Lamps Excluded

| Code | Lens | IP Rating | Size (mm) |
|-----------------|-------|-----------|-----------------|
| BK6009 | PC | IP65 | 260 x 300 x 180 |
| NB1269 | PC | IP44 | 310 x 258 x 255 |
| EL-616 | Glass | IP65 | 418 x 314 x 203 |
| EL-616-PC-EMPTY | PC | IP65 | 418 x 314 x 203 |

BK6003



FL1057

Rectangular Bulkheads - Input Voltage: 230VAC I E27

Lamp Holder I Lamps Excluded I Aluminium Body I Glass Cover

| Code | Lens | IP Rating | Size (mm) |
|--------|-------|-----------|-----------------|
| BK6003 | PC | IP54 | 280 x 175 x 133 |
| FL1057 | Glass | IP65 | 330 x 230 x 190 |

LED INDUSTRIAL VANDAL PROOF

5 Year Warranty



V004579



V004586

LED Industrial Round Vandal Proof - IP54 Input Voltage: 220-240VAC I Colour Temp: 4000K I L70B10

ta30 - 100 000h I White painted metal frame RAL9003 with PC Cover I Direct fastening on ceiling or wall light I

Applications : Areas with high risk I.e. Prison Cells, Psychiatric Hospitals, Gymnasiums and Pedestrian Subways.

| Code | Power | Lumens | Size (mm) |
|----------------------|-------|--------|-----------|
| CLUMBER3-LED-1500-4K | 8W | 1047lm | Ø208 x 63 |
| CLUMBER2-LED-2650-4K | 19W | 1819lm | Ø370 x 63 |
| CLUMBER1-LED-6200-4K | 44W | 4690lm | Ø505 x 63 |

Accessories

| Code | Description |
|---------|------------------------------|
| V004579 | TORX Security Screw M5 x 12 |
| V004586 | BIT25 tool for Screw M5 x 12 |

5 Year Warranty



V004579



V004586

LED Industrial Box Vandal Proof - IP64 Input Voltage: 220-240VAC I Colour Temp: 4000K I L70B10 ta30 -

100 000h I White painted metal frame RAL9003 with PC Cover I Direct fastening on ceiling or wall light I

Applications : Areas with high risk I.e. Prison Cells, Psychiatric Hospitals, Gymnasiums and Pedestrian Subways.

| Code | Power | Lumens | Size (mm) |
|-------------------|-------|--------|-----------------|
| BOXER-LED-3300-4K | 25W | 2584lm | 700 x 184 x 56 |
| BOXER-LED-6600-4K | 53W | 5168lm | 1257 x 184 x 56 |
| BOXER-LED-8200-4K | 66W | 6421lm | 1537 x 184 x 56 |

Accessories

| Code | Description |
|---------|------------------------------|
| V004579 | TORX Security Screw M5 x 12 |
| V004586 | BIT25 tool for Screw M5 x 12 |

T8 LED WEATHERPROOF LINEAR LIGHTS IP65



LED Tubes to be ordered separately see page 1-3

Wiring Diagram

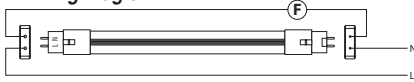

LED Standard Weatherproof Linear Light IP65 c/w Fuse Links | Easy Replacement

| Wired for L+N one end, Link Opposite end. **LED Tubes Excluded**

| Clear Diffuser | Opal Diffuser | LED Tube Code | Lamp Power | Size (mm) |
|----------------|---------------|---------------|------------|-----------|
|----------------|---------------|---------------|------------|-----------|

Single Tube

| | | | | |
|------------------|------------------|---------------------|--------------|----------------|
| LED-YZ-T8-8W-NT | YZ-8118-OP-EMPTY | LEDT8-A2FR-CW or DL | 1x 8W (2FT) | 675 x 85 x 90 |
| LED-YZ-T8-18W-NT | YZ-8136-OP-EMPTY | LEDT8-A4FR-CW or DL | 1x 18W (4FT) | 1278 x 85 x 90 |
| LED-YZ-T8-22W-NT | YZ-8158-OP-EMPTY | LEDT8-A5FR-CW or DL | 1x 22W (5FT) | 1578 x 85 x 90 |

Double Tube

| | | | | |
|--------------------|------------------|---------------------|--------------|-----------------|
| LED-YZ-T8-2X8W-NT | YZ-8218-OP-EMPTY | LEDT8-A2FR-CW or DL | 2x 8W (2FT) | 675 x 110 x 80 |
| LED-YZ-T8-2X18W-NT | YZ-8236-OP-EMPTY | LEDT8-A4FR-CW or DL | 2x 18W (4FT) | 1278 x 110 x 80 |
| LED-YZ-T8-2X22W-NT | YZ-8258-OP-EMPTY | LEDT8-A5FR-CW or DL | 2x 22W (5FT) | 1578 x 110 x 80 |

For LED tubes see page 1-3 | For Emergency Add Emergency Tube Code on page 3

Accessories

| Code | Wattage |
|---------------|-----------------------------------------------|
| LED-YZ-CLIP/S | Stainless Steel holding clips for YZ Diffuser |



LED Tubes to be ordered separately see page 1-3

Accessories Supplied

LED Economy Weatherproof Linear Light IP65 Material: ABS & Polycarbonate Diffuser | Supplied without LED Tube

| Code | Power | Dimensions |
|-------------|---------|-------------------|
| LEDWPT8-109 | 1 x 9W | 650 x 74 x 61mm |
| LEDWPT8-209 | 2 x 9W | 650 x 110 x 61mm |
| LEDWPT8-118 | 1 x 18W | 1250 x 74 x 61mm |
| LEDWPT8-218 | 2 x 18W | 1250 x 110 x 61mm |
| LEDWPT8-122 | 1 x 22W | 1550 x 74 x 61mm |
| LEDWPT8-222 | 2 x 22W | 1550 x 110 x 61mm |

For LED tubes see page 1-3 | For Emergency Add Emergency Tube Code on page 3



LED Weatherproof Linear Light with Motion Sensor IP65 Ideal for parking lots

Input Voltage: 230VAC | ABS + PC | Colour Temperature 6000K | Integrated Microwave Sensor | Time Setting: 10sec to 30min | Light Control: 10-2000 lux | Detection Range: 1-8m (Radius) (Adjustable)

| Code | Wattage | Lumen | Size (mm) |
|------------|---------|--------|----------------|
| BW-ECO2-18 | 18W | 1500lm | 568 x 70 x 55 |
| BW-ECO2-36 | 36W | 3000lm | 1168 x 70 x 55 |
| BW-ECO2-48 | 48W | 4000lm | 1480 x 70 x 55 |



Input Voltage: 230VAC | ABS Body + PC Diffuser | Colour Temperature 4000K | Integrated Microwave Sensor | Time Setting: 5s/90s/5min/15min | Detection Area: 10%-50%-75%-100% | Daylight Threshold: 2lux-10lux-50lux-Disable | Detection Range: Max. Ø14m (Ceiling) and Max. Ø10m (Wall)

| Code | Wattage | Lumen | Size (mm) |
|---------------|---------|--------|----------------|
| LG136C-E-S-CW | 23W | 2300lm | 1265 x 89 x 92 |



LED Integrated Weatherproof Linear Light IP65 - Supply Voltage 230VAC | Colour Temp 6500K (Daylight) | Snap on lens cover (no clips/screws) | Easy connection (no need to open fitting) | PC Base and Lens / Aluminium heat sink

| Code | Wattage | Lumen | Max Series Connection | Size (mm) |
|-----------|---------|--------|-----------------------|----------------|
| BW-ECO-18 | 18W | 1500lm | 20 | 590 x 86 x 66 |
| BW-ECO-36 | 36W | 3000lm | 10 | 1180 x 86 x 66 |
| BW-ECO-48 | 48W | 4000lm | 8 | 1480 x 86 x 66 |

T8 LED WEATHERPROOF LINEAR LIGHTS IP65

LED Mining Weatherproof Linear Light IP65 Input Voltage: 85 - 265VAC | c/w LED Tubes 6000K (Daylight) | c/w 2 x Stainless Steel Clips & 2 x Hooks

| Codes c/w LED Tube | Wattage | Supplied with | Size (mm) |
|-----------------------|---------|----------------------------------------------------------------|-----------------|
| MYZ-2X22W | 2 x 22W | 1.5m Cable & 2P + E 16A Industrial Plug 2 x Daylight LED Tubes | 1578 x 129 x 90 |
| MYZ-2X18W-E27 | 2 x 18W | 1.5m Cable & E27 Lamp Holder | 1278 x 129 x 90 |
| MYZ-2X22W-E27 | 2 x 22W | 1.5m Cable & E27 Lamp Holder | 1578 x 129 x 90 |

• For LED tubes see page 1-3

• For Emergency Add Emergency Tube Code on page 3

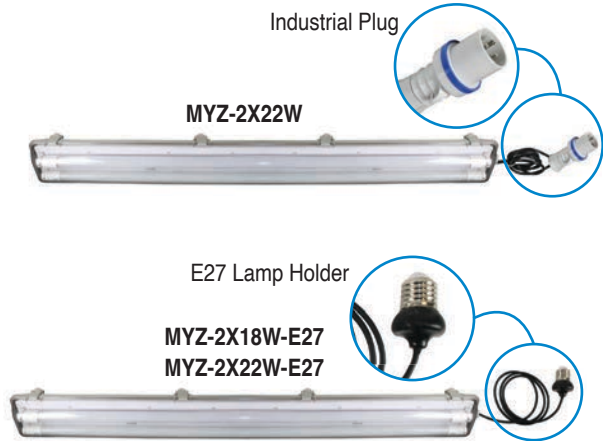

Industrial Plug

MYZ-2X22W

E27 Lamp Holder

MYZ-2X18W-E27
MYZ-2X22W-E27

T8 FLUORESCENT WEATHERPROOF LIGHT FITTINGS IP65

YZ & F7 Range - Material: ABS Base & Clip, Clear Poly-Carbonate diffuser |

Working Temp: 85°C max | PF >0.97

| Lamp Power | Size (mm) L x B x H | Codes | | | |
|---------------|------------------------|--------------|---------------------------|---------------------------|--------------------|
| | | Iron Ballast | Electronic Ballast (240V) | Electronic Ballast (110V) | *c/w Emergency Kit |
| 1 x 18W (2FT) | 675 x 85 x 90 | YZ-8118A | YZ-8118-ELC 240V | YZ-8118-ELC 110V | - |
| 1 x 36W (4FT) | 1278 x 85 x 90 | YZ-8136A | YZ-8136-ELC 240V | YZ-8136-ELC 110V | YZ-8136-EMG |
| 1 x 58W (5FT) | 1578 x 85 x 90 | YZ-8158A | YZ-8158-ELC 240V | YZ-8158-ELC 110V | YZ-8158-EMG |
| 2 x 18W (2FT) | 675 x 129 x 90 | YZ-8218A | YZ-8218-ELC 240V | YZ-8218-ELC 110V | YZ-8218-EMG |
| 2 x 36W (4FT) | 1278 x 129 x 90 | YZ-8236A | YZ-8236-ELC 240V | YZ-8236-ELC 110V | YZ-8236-EMG |
| 2 x 58W (5FT) | 1578 x 129 x 90 | - | YZ-8258-ELC 240V | YZ-8258-ELC 110V | YZ-8258-EMG |
| 3 x 18W (2FT) | 675 x 220 x 110 | F7318 | F7318-ELC 240V | - | F7318-EMG |
| 3 x 36W (4FT) | 1278 x 220 x 110 | F7336 | F7336-ELC 240V | - | F7336-EMG |

*1 Lamp fitted with emergency kit @ 11% of full power for 1 hour

YZ Range - Empty - Material: ABS Base & Clip, Poly-Carbonate diffuser | Working Temp: 85°C max |

Supplied without gear

| Lamp Power | Size (mm) L x B x H | Codes | | | |
|---------------|------------------------|--------------------------|----------------------|-------------------------|---------------------|
| | | Body with Clear Diffuser | Spare Clear Diffuser | Body with Opal Diffuser | Spare Opal Diffuser |
| 1 x 18W (2FT) | 675 x 85 x 90 | YZ-8118-EMPTY | YZ-8118-DIF | - | - |
| 1 x 36W (4FT) | 1278 x 85 x 90 | YZ-8136-EMPTY | YZ-8136-DIF | - | - |
| 1 x 58W (5FT) | 1578 x 85 x 90 | YZ-8158-EMPTY | YZ-8158-DIF | - | - |
| 2 x 18W (2FT) | 675 x 129 x 90 | YZ-8218-EMPTY | YZ-8218-DIF | - | - |
| 2 x 36W (4FT) | 1278 x 129 x 90 | YZ-8236-EMPTY | YZ-8236-DIF | YZ-8236-OP-EMPTY | YZ-8236-OP-DIF |
| 2 x 58W (5FT) | 1578 x 129 x 90 | YZ-8258-EMPTY | YZ-8258-DIF | YZ-8258-OP-EMPTY | YZ-8258-OP-DIF |
| 3 x 18W (2FT) | 675 x 220 x 110 | - | F7318-DIF | - | - |
| 3 x 36W (4FT) | 1278 x 220 x 110 | - | F7336-DIF | - | - |

F7D Range - High Temp Rating - Material: Poly-Carbonate Base & Clear Poly-Carbonate diffuser |

Working Temp: 120°C max | PF >0.97 | Cover & internal plate can be hinged

| Lamp Power | Size (mm) L x B x H | Codes | | | |
|---------------|------------------------|--------------|---------------------------|--------------------|----------------------|
| | | Iron Ballast | Electronic Ballast (240V) | *c/w Emergency Kit | Spare Clear Diffuser |
| 2 x 36W (4FT) | 1268 x 158 x 101 | F-7236D | F-7236D-ELC 240V | F-7236D-ELC 110V | F-7236D-DIF |
| 2 x 58W (5FT) | 1568 x 158 x 101 | - | F-7258D-ELC 240V | F-7258D-ELC 110V | F-7258D-DIF |



YZ Range

F7 Range



Opal

Clear

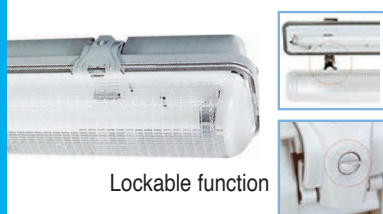

Lockable function

T8 FLUORESCENT WEATHERPROOF LIGHT FITTINGS IP65

| YZ-CLIP/S | | YZ-CLIP/P | | Accessories - For YZ Range | | Accessories - For F7 & F7-D Range | |
|-----------|---------------------------------------|-------------|-----------------------------------------|-----------------------------------------------------|---------------------------------------|-----------------------------------|-----------------------------------------|
| Code | Description | Code | Description | Code | Description | Code | Description |
| YZ-CLIP/C | Plastic holding clips for YZ Diffuser | F7-CLIP/P | Plastic holding clips for F7 Diffuser | YZ-CLIP/P | S/Steel holding clips for YZ Diffuser | F7-CLIP/S | S/Steel holding clips for F7 Diffuser |
| YZ-CLIP/M | S/Steel holding clips for YZ Diffuser | F7D-CLIP/P | Plastic holding clips for F7-D Diffuser | YZ-CLIP/M | S/Steel surface mount clips | F7D-CLIP/S | S/Steel holding clips for F7-D Diffuser |
| YZ-CLIP/C | Chassis assembly clips | F7318-DIF | Spare Diffuser for F7318 Fitting | YZ-CLIP/C | | F7336-DIF | Spare Diffuser for P7336 Fitting |
| | | | | Accessories - Spare Ballasts for YZ Fittings | | | |
| | | | | Emergency Accessories - For YZ Fittings | | | |
| | | | | | | | |
| Code | Description | Code | Description | Code | Description | Code | Description |
| BYZ-18W | 18 Watt Ballast | YZ-EMG-2X18 | 2x18W Emergency Ballast c/w Batteries | BYZ-36W | 36 Watt Ballast | YZ-EMG-2X36 | 2x36W Emergency Ballast c/w Batteries |
| BYZ-58W | 58 Watt Ballast | YZ-EMG-2X58 | 2x58W Emergency Ballast c/w Batteries | BYZ-2X18W | 2 x 18 Watt Ballast | YZ-BAT | Battery for emergency fitting only |
| BYZ-2X36W | 2 x 36 Watt Ballast | YZ-EMG | Emergency Ballast | BYZ-2X58W | 2 x 58W Ballast | | |

T5 FLUORESCENT WEATHERPROOF FITTINGS IP65

IP65 Weatherproof Light Fitting

Supplied with electronic ballasts
 Material: ABS Base & Polycarbonate diffuser
 Working Temp: 85°C max



| Lamp Power | Single Lamp | | | Twin Lamp | | |
|------------|--------------------|-------------------|------------------|--------------------|-------------------|------------------|
| | Code | c/w Emergency Kit | Size L x W x H | Code | c/w Emergency Kit | Size L x W x H |
| 14W(2ft) | YZ-1T514W-ELC 240V | - | 610 x 60 x 74mm | YZ-2T514W-ELC 240V | YZ-2T514W-EMG | 610 x 60 x 74mm |
| 28W(4ft) | YZ-1T528W-ELC 240V | YZ-1T528W-EMG | 1210 x 60 x 74mm | - | - | 1210 x 60 x 74mm |
| 54W(4ft) | YZ-1T554W-ELC 240V | YZ-1T554W-EMG | 1210 x 60 x 74mm | YZ-2T554W-ELC 240V | - | 1210 x 60 x 74mm |
| 35W(5ft) | YZ-1T535W-ELC 240V | YZ-1T535W-EMG | 1510 x 60 x 74mm | YZ-2T535W-ELC 240V | YZ-2T535W-EMG | 1510 x 60 x 74mm |
| 49W(5ft) | YZ-1T549W-ELC 240V | YZ-1T549W-EMG | 1510 x 60 x 74mm | YZ-2T549W-ELC 240V | YZ-2T549W-EMG | 1510 x 60 x 74mm |
| 80W(5ft) | YZ-1T580W-ELC 240V | YZ-1T580W-EMG | 1510 x 60 x 74mm | YZ-2T580W-ELC 240V | YZ-2T580W-EMG | 1510 x 60 x 74mm |

For LED Tubes see page 3

T8 LED STAINLESS STEEL LIGHT FITTINGS IP65

Material: 304 Stainless steel base
 & tempered glass diffuser.
 Working temperature: 120°C
 Application: Chemical factories, etc.



| Lamp Power | Size L x W x H | *Wired for LED | Spare Diffuser |
|---------------|-------------------|----------------|----------------|
| 1 x 8W (2FT) | 710 x 140 x 97mm | LED-SS-8118A | SS-8118-DIF |
| 1 x 18W (4FT) | 1310 x 140 x 97mm | LED-SS-8136A | SS-8136-DIF |
| 1 x 22W (5FT) | 1610 x 140 x 97mm | LED-SS-8158A | SS-8158-DIF |
| 2 x 8W (2FT) | 710 x 210 x 97mm | LED-SS-8218A | SS-8218-DIF |
| 2 x 18W (4FT) | 1310 x 210 x 97mm | LED-SS-8236A | SS-8236-DIF |
| 2 x 22W (5FT) | 1610 x 210 x 97mm | LED-SS-8258A | SS-8258-DIF |

*Note: Lamps Excluded, For LED Tubes see page 1-3 | For Emergency Add Emergency Tube Code on Page 3

Accessories

| Code | Description |
|-------|------------------------------------------------------|
| EL-FL | Fuse Link (To be Ordered Separately for LED Version) |

For Polycarbonate diffuser add -PCDIF to code. For example: SS-8258-PCDIF

T8 FLUORESCENT STAINLESS STEEL LIGHT FITTINGS IP65

Material: 304 Stainless steel base
& tempered glass diffuser.
Working temperature: 120°C
Application: Chemical factories, etc.



| Lamp Power | Size L x W x H | Iron Ballast | Electronic Ballast (240V) | Electronic Ballast (110V) | Spare Diffuser |
|---------------|-------------------|--------------|---------------------------|---------------------------|----------------|
| 1 x 18W (2FT) | 710 x 140 x 97mm | SS-8118A | SS-8118-ELC 240V | SS-8118-ELC 110V | SS-8118-DIF |
| 1 x 36W (4FT) | 1310 x 140 x 97mm | SS-8136A | SS-8136-ELC 240V | SS-8136-ELC 110V | SS-8136-DIF |
| 1 x 58W (5FT) | 1610 x 140 x 97mm | SS-8158A | SS-8158-ELC 240V | SS-8158-ELC 110V | SS-8158-DIF |
| 2 x 18W (2FT) | 710 x 210 x 97mm | SS-8218A | SS-8218-ELC 240V | SS-8218-ELC 110V | SS-8218-DIF |
| 2 x 36W (4FT) | 1310 x 210 x 97mm | SS-8236A | SS-8236-ELC 240V | SS-8236-ELC 110V | SS-8236-DIF |
| 2 x 58W (5FT) | 1610 x 210 x 97mm | SS-8258A | SS-8258-ELC 240V | SS-8258-ELC 110V | SS-8258-DIF |

For Polycarbonate Diffuser add **-PCDIF** to code. For example: **SS-8258-PCDIF**

T8 LED ALUMINIUM FITTINGS IP65



LED-F7118F



| Wired for LED | Lamp Power | Size L x W x H |
|---------------|---------------|-------------------|
| LED-F7118F | 1 x 8W (2FT) | 675 x 120 x 95mm |
| LED-F7218F | 2 x 8W (2FT) | 675 x 150 x 95mm |
| LED-F7136F | 1 x 18W (4FT) | 1285 x 120 x 95mm |
| LED-F7236F | 2 x 18W (4FT) | 1285 x 150 x 95mm |
| LED-F7158F | 1 x 22W (5FT) | 1585 x 120 x 95mm |
| LED-F7258F | 2 x 22W (5FT) | 1585 x 150 x 95mm |

Material: Aluminium base and tempered glass cover. Stainless Steel Clips

For Lamps see page 1-3 | For Emergency Add Emergency Tube Code on Page 3

Accessories

| Code | Description |
|------------|------------------------------------------------------|
| NF7-CLIP/S | Spare Stainless Steel Clips |
| EL-FL | Fuse Link (To be Ordered Separately for LED Version) |

For Spare Glass add **-DIF** to Code. For example: **F7258F-DIF**

T8 FLUORESCENT ALUMINIUM FITTINGS IP65



F7118F



| Iron Ballast | Elec. Ballast | Emerg. Ballast | Lamp Power | Size L x W x H |
|--------------|---------------|----------------|---------------|-------------------|
| F7118F | F7118F-ELC | - | 1 x 18W (2FT) | 675 x 120 x 95mm |
| F7218F | - | F7218F-EMG | 2 x 18W (2FT) | 675 x 150 x 95mm |
| F7136F | F7136F-ELC | - | 1 x 36W (4FT) | 1285 x 120 x 95mm |
| F7236F | F7236F-ELC | F7236F-EMG | 2 x 36W (4FT) | 1285 x 150 x 95mm |
| F7158F | F7158F-ELC | - | 1 x 58W (5FT) | 1585 x 120 x 95mm |
| F7258F | F7258F-ELC | F7258F-EMG | 2 x 58W (5FT) | 1585 x 150 x 95mm |

Material: Aluminium base and tempered glass cover.

For T8 type lamps. Stainless Steel Clips

For Lamps see page 19

For Spare Glass add **-DIF** to Code. For example: **F7258F-DIF**

Accessories

| Code | Description |
|------------|-----------------------------|
| NF7-CLIP/S | Spare Stainless Steel Clips |

LED WEATHERPROOF LINEAR LIGHTING IP65

LED Weatherproof Linear Light - Input voltage: 230VAC | Extruded body | IK08 | RA > 80 | Mounting Kit Included | 400W max in series

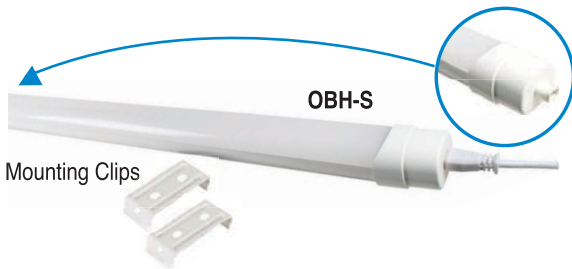

| Code | Wattage | Lumen | Size (mm) |
|--------------------------------------------|---------|--------|----------------|
| Ultra Slim - Linkable / PC Diffuser | | | |
| OBH-S-18W-* | 18W | 1440lm | 600 x 43 x 38 |
| OBH-S-36W-* | 36W | 2880lm | 1200 x 43 x 38 |
| OBH-S-45W-* | 45W | 3840lm | 1500 x 43 x 38 |

Accessories

| Code | Description |
|--------|-----------------------|
| OBH-MC | 1m Middle Connector |
| OBH-PC | 500mm Power Connector |

| Code | Wattage | Lumen | Size (mm) |
|--------------------------------------------------------|---------|--------|----------------|
| Standard Slimline - Quick Connect Power Adaptor | | | |
| LG08C-06-18W-* | 18W | 1650lm | 650 x 72 x 42 |
| LG08C-12-36W-* | 36W | 3300lm | 1250 x 72 x 42 |
| LG08C-15-45W-* | 45W | 4000lm | 1560 x 72 x 42 |

High Power Slimline - With 230mm Fly Lead

| | | | |
|------------------|-----|--------|----------------|
| MDT-1701-SMD30-* | 30W | 2700lm | 662 x 78 x 38 |
| MDT-1702-SMD60-* | 60W | 5400lm | 1232 x 78 x 38 |
| MDT-1703-SMD70-* | 70W | 6300lm | 1532 x 78 x 38 |

*Add colour to code: ○ CW (Cool White) 4200K, ○ DL (Daylight) 6000K

LED Weatherproof Linear Light - Supply Voltage 100 - 240VAC | 2 x LED chip boards to ensure even lighting | Colour temp 6500K (Daylight) | PC Base and Lens | Aluminium heat sink | Series connection possible | Easy connection | Mounting Kit Included

| Code | Wattage | Lumen | Size (mm) |
|---------------|---------|--------|----------------|
| RW-PK-WP60-1 | 9W | 800lm | 610 x 50 x 49 |
| RW-PK-WP120-1 | 18W | 1600lm | 1210 x 50 x 49 |
| RW-PK-WP150-1 | 22W | 1900lm | 1510 x 50 x 49 |

LED Tri-Proof Fitting - Input Voltage: 230VAC | 130lm/W | Colour Temperature: 6000K | Seamless Connection | c/w Surface Mounting Kit | c/w Waterproof End Cap | Suspension Kit Optional | Power-Connector not included

| Code | Code | Wattage | Lumen | Size (mm) |
|--------------------------|-----------------|---------|--------|----------------|
| Standard - 2 Wire | | | | |
| | Dimmable | | | |
| 01TP-C2F-15 | 01TP-C2F-D-15 | 15W | 1950lm | 600 x 67 x 67 |
| 01TP-C4F-33 | 01TP-C4F-D-33 | 33W | 4290lm | 1200 x 67 x 67 |
| 01TP-C5F-45 | 01TP-C5F-D-45 | 45W | 5850lm | 1500 x 67 x 67 |

Emergency - Lithium Ion | With Test Button | 4 Wire

| | | | |
|---------------|-----|------------------|----------------|
| 01TP-C2F-E-15 | 15W | 1950lm (E-280lm) | 600 x 67 x 67 |
| 01TP-C4F-E-33 | 33W | 4290lm (E-460lm) | 1200 x 67 x 67 |
| 01TP-C5F-E-45 | 45W | 5850lm (E-560lm) | 1500 x 67 x 67 |

Accessories - 2 Wire & 4 Wire

| 2 Wire Codes | Description | 4 Wire Codes | Description |
|--------------|--------------------------|--------------|--------------------------|
| 01TP-2W-PC | 1m Power Connector | 01TP-4W-PC | 1m Power Connector |
| 01TP-2W-JB | Seamless Joining Bracket | 01TP-4W-JB | Seamless Joining Bracket |
| 01TP-2W-JL | 1m Jumper Lead | 01TP-4W-JL | 1m Jumper Lead |
| 01TP-2W-MS | Microwave sensor | 01TP-4W-MS | Microwave sensor |

LED WEATHERPROOF LINEAR LIGHTING IP65

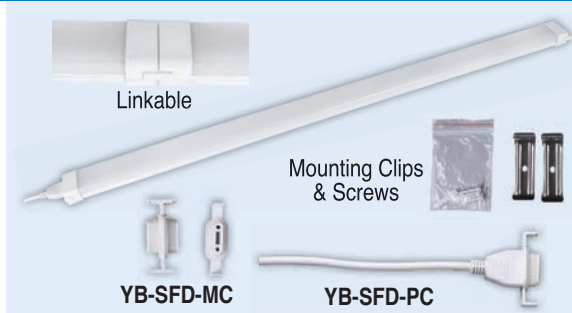

LED Linear Light - Input Voltage: 110-240VAC | Linkable | Easy Installation | c/w Mounting Clips, End Caps and 300mm Power Connector

| Codes | Wattage | Lumen | Size (mm) |
|----------------|---------|--------|----------------|
| YB-SFD01-18W-* | 18W | 1500lm | 600 x 60 x 29 |
| YB-SFD01-36W-* | 36W | 3200lm | 1200 x 60 x 29 |

*Add Colour to Code: ○ CW (Cool White - 4200K), ○ DL (Daylight - 6000K)

| Code (Accessories) | Description |
|--------------------|------------------------------|
| YB-SFD-PC | 300mm Power Connector |
| YB-SFD-MC | Middle Connector for Linking |

LED WEATHERPROOF LINEAR LIGHTING IP66



Narrow Body - Input Voltage: 230VAC | Integrated LED | CRI ≥80 | Material: PC | Mounting Clips Included | Supplied with 230mm Fly Lead

| Code | Power | Lumens | Size (mm) |
|-----------------|-------|--------|----------------|
| ZJT-0760-15W-* | 15W | 1425lm | 600 x 70 x 65 |
| ZJT-0790-20W-* | 20W | 1900lm | 900 x 70 x 65 |
| ZJT-07120-36W-* | 36W | 3600lm | 1200 x 70 x 65 |
| ZJT-07150-42W-* | 42W | 4200lm | 1500 x 70 x 65 |

Wide Body - Input Voltage: 230VAC | Integrated LED | CRI ≥80

| | | | |
|-----------------|-----|--------|-----------------|
| ZJT-1360-20W-* | 20W | 1900lm | 600 x 134 x 61 |
| ZJT-1390-30W-* | 30W | 2850lm | 900 x 134 x 61 |
| ZJT-13120-42W-* | 42W | 4200lm | 1200 x 134 x 61 |

*Add colour to code: ○ CW (Cool White) 4200K, ○ DL (Daylight) 6000K

LED LINEAR LIGHTING IP20



LED T8 Batten - Input Voltage: 220 - 240VAC | No Light Fitting Required | Easy Installation | Colour Temperature: 6000K (Daylight)

| Code | Wattage | Lumen | Size (mm) |
|---------------------|---------|--------|----------------|
| LEDT8-001A-9W-DL | 9W | 900lm | 610 x 40 x 34 |
| LEDT8-001A-18W-DL | 18W | 1800lm | 1120 x 40 x 34 |
| LEDT8-001A-2x9W-DL | 2 x 9W | 1800lm | 610 x 84 x 34 |
| LEDT8-001A-2x18W-DL | 2 x 18W | 3600lm | 1120 x 84 x 34 |

| Code (Accessories) | Description |
|--------------------|---------------------------|
| W1023 | 1m Figure 8 Linking Cable |

LED Batten EMG IP20 - Input Voltage: 230VAC | Colour Temp 6500K | Battery 2 x 1.8/Ah x 2 | 3hr Backup Time | Steel Body & PC Cover

| Code | Wattage | Emg. Watts | Lumens | Size (mm) |
|----------------|---------|------------|--------|---------------|
| EMG-BAT-40W-DL | 40W | 4W | 75lm/W | 650 x 98 x 28 |



LED Linear Light - Input Voltage: 230VAC | Aluminium body with PC diffuser | c/w Mounting Screws

| Code | Wattage | Lumen | Size (mm) |
|----------------|---------|--------|-----------------|
| GJZ-F10S-20W-* | 20W | 2000lm | 675 x 108 x 45 |
| GJZ-F10S-40W-* | 40W | 4000lm | 1269 x 108 x 45 |

*Add Colour to Code: ○ WW (Warm White) 3000K, ○ CW (Cool White) 4200K, ○ DL (Daylight) 6000K

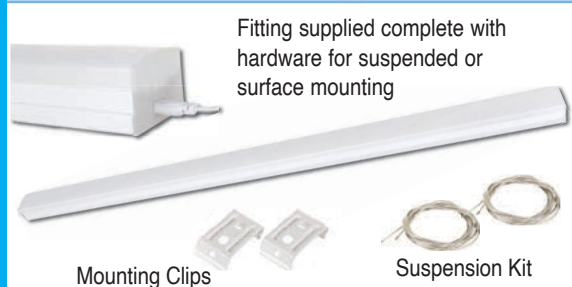

LED Linear Light - Colour Temperature: 4200K (Cool White) | Linkable | CRI >70

| Code | Wattage | Lumens | Size (mm) |
|------------------|---------|--------|----------------|
| TDL-G45017-36-CW | 36W | 2880lm | 1200 x 65 x 35 |

| Accessories | |
|-------------|-----------------------------|
| Code | Description |
| LC-1000 | 1m Figure 8 Linking Cable |
| LC-1500 | 1.5m Figure 8 Linking Cable |

LED LINEAR LIGHTING IP20



Aluminium Linkable without Parabolic Reflector - Input Voltage: 180 - 240VAC | 2 Part Design | Single or Interlink | Seamless Design | 120° Beam Angle | Frosted Diffuser

| Code | Wattage | Lumens | Size (mm) |
|---------------|---------|--------|----------------|
| LINA-120-40-* | 40W | 5600lm | 1190 x 57 x 67 |
| LINA-150-60-* | 60W | 8400lm | 1490 x 57 x 67 |

*Add colour temp to code: ○ CW (Cool White - 4000K), ○ DL (Daylight - 6000K)

Accessories

| Code | Description |
|-----------|--------------------------------------|
| LIN1A-A | Middle Connector |
| LIN01-B | Suspension Kit, 2Pcs, 1 Meter Length |
| LINA-R-12 | 1200mm Parabolic Reflector |
| LINA-R-15 | 1500mm Parabolic Reflector |



Linkable Linear - Input Voltage: 100 - 265VAC | 120° Beam Angle | Aluminium body & PC Cover | Single or interlink | Seamless design | Supplied with Mounting Accessories

| Code | Wattage | Lumens | Max Linkable Qty | Size (mm) |
|--------------|---------|--------|------------------|----------------|
| EVB-120-40-* | 40W | 5200lm | 35 | 1200 x 73 x 55 |
| EVB-150-60-* | 60W | 7800lm | 28 | 1500 x 73 x 55 |

* Add Colour Temperature to Code: ○ CW (4000K), ○ DL (6000K)

ALUMINIUM LED LINEAR LIGHTS IP40



LED Linear Light - c/w 1m Suspension Kit and Linking Connector | Linkable

| Code | XLN-1200-40W-* | XLN-1500-50W-* |
|-----------|----------------|----------------|
| Voltage | 230VAC | 230VAC |
| Power | 36W | 48W |
| Size (mm) | 1200 x 54 x 85 | 1500 x 54 x 85 |
| Lumen | 3060 | 4080 |
| CRI | 80 | 80 |

*Add colour to code: ○ CW (Cool White), ○ WW (Warm White)

Aluminium Profile - Empty | Ready to fit Strip Light

| Code | Description | Code | Description |
|-----------|---------------------------------------|-----------|--------------------|
| ALP052/2M | 2m Aluminium Profile | ALP052-EC | End Cap with Hole |
| ALP052-FD | PC Diffuser Cover (Frosted) | ALP052-SW | 2m Suspension Wire |
| ALP-LINK | Middle Connector to join two profiles | | |

(To make up complete set, order profile, diffuser, end cap & suspension wire)

LED Linear Light - 230VAC | c/w 1m Suspension Kit

| Code | GL-LS3050-1200-* | GL-LS3050-1500-* | GL-LS3050-2400-* |
|-----------|------------------|------------------|------------------|
| Power | 23W | 28W | 36W |
| Size (mm) | 1200 x 38 x 60 | 1500 x 38 x 60 | 2400 x 38 x 60 |
| Lumen | 1800lm | 2300lm | 3600lm |

*Add colour to code: ○ WW (Warm White), ○ CW (Cool White)

| Code (Accessories) | Description |
|--------------------|---------------------------------------|
| GL-LS3050-WIRE | 1m Suspension Kit |
| GL-LS3050-FLUSH | Surface Mount Bracket |
| GL-LS3050-LINK | Middle Connector to join two profiles |

NEW

3 CCT ADJUSTABLE LINEAR LIGHTS

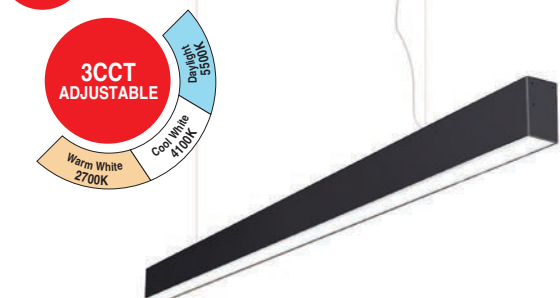

3CCT Adjustable Linear Light - High quality LED linear light for office, architectural, school, display centres, shops and stores | Colour Temperature Adjustable by Switch | Suspended or Surface Mount | c/w Suspension Kit and Linkable Link | Aluminium Body & PC Diffuser

| Code | HZ-L600-20W-* | HZ-L1200-40W-* |
|-------------------------|-------------------|-------------------|
| Voltage | 100-270VAC | 100-270VAC |
| Wattage | 20W | 40W |
| Size (mm) | 600 x 55 x 70 | 1200 x 55 x 70 |
| Lumens | 2000lm | 4000lm |
| Selectable Colour Temp. | 2700K-4100K-5500K | 2700K-4100K-5500K |

* Add Finish Colour to Code: S (Silver), BLK (Black)

LED LINEAR LIGHTING IP20



LED Single Round Shape Pendant

- Supply voltage: AC 190-240V
- Material: Aluminium
- Power factor: PF > 0.9
- Beam angle: 145°
- Mounting Kit: Included

| | |
|--------------------|---------------------|
| Code | LD-PD-SR-18W |
| Wattage | 18W |
| Luminous Flux | 1260lm |
| Colour Temperature | 6000K (Pure White) |

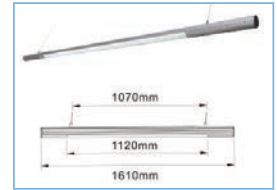

LED Double Round Shape Pendant

- Supply voltage: AC 190-240V
- Material: Aluminium
- Power factor: PF > 0.9
- Beam angle: 145°
- Mounting Kit: Included

| | |
|--------------------|---------------------|
| Code | LD-PD-DR-36W |
| Wattage | 36W |
| Luminous Flux | 2520lm |
| Colour Temperature | 6000K (Pure White) |

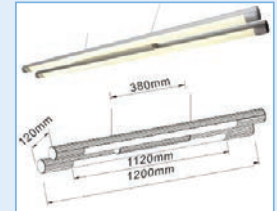

LED CONNECTABLE LINEAR LIGHTING IP20



LED Two-In-One Pendant Lighting -

Can be used as either an individual fitting or can be connected using the accessories below.

- Supply voltage: AC 190-240V
- Material: Aluminium
- Power factor: PF > 0.9
- Beam angle: 145°
- Mounting Kit: Included

| | |
|--------------------|---------------------|
| Code | LD-PD-EL-36W |
| Wattage | 36W |
| Luminous Flux | 90lm/W |
| Colour Temperature | 6000K (Pure White) |

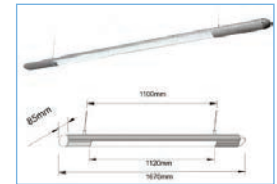

Connectable Accessories



| Code | LD-SC | LD-LC | LD-TC | LD-XC | LD-CB |
|-------------|---------------------------------------|--------------------------------------|---------------------------------------|----------------------------------------|-----------------------|
| Description | Straight connector 100 x 80 x 51mm | Left or Right bend 80 x 80 x 51mm | "T" Type connector 100 x 90 x 51mm | "+" Type connector 100 x 100 x 51mm | Spare connector block |

NEW

LED LINEAR LIGHTS

3 Year
Warranty



Recessed Mount LED Linear Light IP20 - Input Voltage 230VAC | 120° Beam Angle | Aluminium & PC Cover | CRI > 80 | Connectable with various configurations | White Finish

| Code | Wattage | Lumens | Size (mm) |
|------------------------|---------|--------|----------------|
| FX-LLR-60-20-* | 20W | 2200lm | 600 x 90 x 35 |
| FX-LLR-120-20-* | 40W | 3800lm | 1200 x 90 x 35 |

*Add colour to code: ○ WW (Warm White 2700K) or ○ CW (Cool White 4200K)

Connectors

| Code | Description | Code | Description |
|-------------------|--------------------|--------------------|-----------------------|
| FX-LLR-SS | Straight Connector | FX-LLR-XC | X Connector |
| FX-LLR-L90 | 90° Connector | FX-LLR-IC90 | Inside 90° Connector |
| FX-LLR-TC | T Connector | FX-LLR-OC90 | Outside 90° Connector |

NEW

LED OFFICE FIXTURES

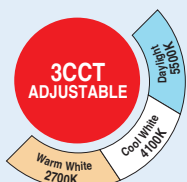

Linear Office Fixture - Input Voltage 230VAC | Direct & Indirect Lighting | Linkable | Frameless LED Panel | UGR < 19 | High Lumen Efficiency | Magnetic Mounting Box for Quick Installation | Adjustable Colour Temp 3000K-4000K

| Code | Wattage | Lumens | Size (mm) |
|----------------------|---------|--------|-----------------|
| UP-PL35120-40 | 40W | 4800lm | 1200 x 350 x 19 |
| UP-PL35120-60 | 60W | 7200lm | 1200 x 350 x 19 |

LED BATTENS IP20

Input Voltage: 230VAC | Mild Steel Body | Two Part for easy installation | c/w Mounting Screws

| Code 2 Year | Code 5 Year | Wattage | Lumen | Size (mm) |
|-----------------------------------|----------------------|---------|--------|----------------|
| Standard Version - 100lm/W | | | | |
| LG05G-06-100-20-* | LG05G-5Y-06-100-20-* | 20W | 2000lm | 630 x 75 x 85 |
| LG05G-12-100-40-* | LG05G-5Y-12-100-40-* | 40W | 4000lm | 1230 x 75 x 85 |
| LG05G-15-100-60-* | LG05G-5Y-15-100-60-* | 60W | 6000lm | 1518 x 75 x 85 |
| High-end Version - 125lm/W | | | | |
| LG05G-06-125-25-* | LG05G-5Y-125-25-* | 25W | 3125lm | 630 x 75 x 85 |
| LG05G-12-125-40-* | LG05G-5Y-125-40-* | 40W | 5000lm | 1230 x 75 x 85 |

*Add Colour to Code: ○ CW (Cool White - 4000K), ○ DL (Day Light - 6500K)



SLIM LINE LED BATTENS IP20

Ultra Slim Profile (Narrow Body) - Input Voltage: 240VAC | High transparent opal diffuser | Easy to mount | Colour Temperature: 6000K | CRI: ≥80

| Code | Wattage | Lumen | Size (mm) L x W x D |
|------------|---------|--------|---------------------|
| DY-30-10W | 10W | 900lm | 300 x 75 x 24 |
| DY-60-20W | 20W | 1800lm | 600 x 75 x 24 |
| DY-120-40W | 40W | 3600lm | 1200 x 75 x 24 |

High Power Ultra Slim Profile (Wide Body) - Input Voltage: 240VAC | High transparent opal diffuser | Easy to mount | Colour Temperature: 6500K | CRI: ≥80

| Code | Wattage | Lumen | Size (mm) L x W x D |
|-----------|---------|--------|---------------------|
| OQ-XT-362 | 30W | 2400lm | 600 x 92 x 32 |
| OQ-XT-721 | 72W | 5760lm | 1200 x 92 x 32 |
| OQ-XT-961 | 96W | 7680lm | 1200 x 128 x 42 |



WALL OR CEILING LED FITTINGS IP20

Input Voltage 230VAC | 4200K (Cool White) | Aluminium with polypropylene diffuser

| Code | Wattage | Lumen | Size (mm) |
|----------------|---------|--------|----------------|
| MB-075-LED-7W | 7W | 600lm | 291 x 53 x 60 |
| MB-075-LED-14W | 14W | 1200lm | 552 x 53 x 60 |
| MB-075-LED-21W | 21W | 1735lm | 900 x 53 x 60 |
| MB-075-LED-28W | 28W | 2380lm | 1200 x 53 x 60 |

Adjustable Wall Light

Input Voltage: 230VAC | Colour Silver | Adjustable Tilt | Material: Aluminium & PC cover with ABS End Caps | Colour Temperature: 4200K

| Code | Wattage | Lumen | Size (mm) |
|-----------|---------|-------|---------------|
| RW-551-10 | 10W | 700lm | 555 x 36 x 75 |



LINKABLE LED UNDERCOUNTER LIGHTING IP20

LED Linear Light - 230VAC - Tough plastic lens and body | Linkable c/w power cord and mounting accessories | Cool white (4000K)

| Code | Wattage | Lumen | Size (mm) |
|--------------|---------|-------------|----------------|
| RW-OC-T5-6W | 6W | 480-520lm | 325 x 22 x 35 |
| RW-OC-T5-10W | 10W | 870-920lm | 586 x 22 x 35 |
| RW-OC-T5-14W | 14W | 1120-1170lm | 885 x 22 x 35 |
| RW-OC-T5-18W | 18W | 1480-1530lm | 1185 x 22 x 35 |

Corner Mounting LED undercounter lighting - 230VAC | 4200K (Cool White) | Linkable, c/w power cord and mounting accessories

| Code | Wattage | Lumen | Size (mm) |
|------------|---------|-------|---------------|
| LDL-5050-1 | 3W | 308lm | 303 x 62 x 21 |
| LDL-5050-2 | 5W | 528lm | 441 x 62 x 21 |
| LDL-5050-3 | 6W | 638lm | 576 x 27 x 11 |

Linkable High output LED undercounter lighting - 230VAC | Linkable c/w power cord and mounting accessories | Cool white (4000K) | Spare Linking Cable: RS-T5-LINK

| Code | Wattage | Lumen | Size (mm) |
|-----------|---------|--------|----------------|
| RS-T5-18W | 18W | 1500lm | 1200 x 24 x 30 |
| RS-T5-24W | 24W | 2000lm | 1500 x 24 x 30 |



T5 & T8 LINEAR FITTINGS

Wall/Ceiling Tri-Phosphor Fluorescent Fittings IP40 - Input Voltage: 230VAC | c/w Lamp | On/off Switch | Acrylic prismatic diffuser | Built-in electronic ballast | Lamp colour: Cool White.

| Code | Lamp | Type | Size (mm) |
|------------|------|---------------|-----------------|
| NB5034-14W | 14W | T5 (Linkable) | 620 x 22 x 44 |
| NB5034-28W | 28W | T5 (Linkable) | 1210 x 22 x 44 |
| NB5002-18W | 18W | T8 | 670 x 35 x 64 |
| NB5002-36W | 36W | T8 | 1280 x 35 x 64 |
| NB5004-24W | 24W | 2G11 (NB5025) | 430 x 104 x 42 |
| NB5004-36W | 36W | 2G11 (NB5025) | 525 x 104 x 42 |
| NB5236-36W | 36W | T8 (FLT8-36) | 1280 x 104 x 42 |

T5-Cabinet Light Fittings - Input Voltage: 220-240V | Built-in electronic ballast | Lamps excluded. See page 19 for lamps

| Code | Description | Size (mm) |
|--------|--------------------------------------------|----------------|
| GL-114 | 14W T5/G5 alum. housing with plastic cover | 570 x 25 x 40 |
| GL-121 | 21W T5/G5 alum. housing with plastic cover | 880 x 25 x 40 |
| GL-128 | 28W T5/G5 alum. housing with plastic cover | 1180 x 25 x 40 |

Input Voltage: 220-240V | Built-in electronic ballast | c/w Lamps | Linkable

| Code | Description | Size (mm) |
|---------|----------------------------------------|---------------|
| TL3003B | Two Lamps 20W each, JC-12-20/G4 Lamp | 550 x 70 x 25 |
| TL3004B | Three Lamps 20W each, JC-12-20/G4 Lamp | 825 x 70 x 25 |

Tiltable Wall Fluorescent Fitting - Input Voltage: 230VAC | Lamp included | Lamp body in Aluminium | Acrylic diffuser. | End covers in ABS plastic | Lamp body finished in Matt Silver. | Lamp holder can be swivelled through 180° | Standard colour: Cool White

| Code | Lamp | Type | Size (mm) |
|------------|------|------|---------------|
| MB-056-8W | 8W | T5 | 340 x 82 x 45 |
| MB-056-21W | 21W | T5 | 906 x 82 x 45 |



OFFICE FIXTURES

LED Light with Prismatic Diffuser - Input Voltage: 100-240VAC | Colour Temp.: 6000K (Daylight) | LED tubes Included

| Code | Wattage | Lumen | Size (mm) |
|--------------|---------|--------|-----------------|
| LU-508-8W | 8W | 800lm | 628 x 100 x 60 |
| LU-508-18W | 18W | 1600lm | 1238 x 100 x 60 |
| LU-509-2X8W | 2 x 8W | 1600lm | 628 x 164 x 60 |
| LU-509-2X18W | 2 x 18W | 3400lm | 1238 x 164 x 60 |
| LU-509-2X22W | 2 x 22W | 3800lm | 1538 x 164 x 60 |

T8 Fluorescent Fittings with Diffuser & P.F. Capacitor. Electronic Ballast.

| Single Lamp Code | Size (mm) L x W x H | Lamp Power | Twin Lamp Code | Size (mm) L x W x H |
|------------------|---------------------|------------|----------------|---------------------|
| MX225-Y20 | 622 x 78 x 85 | 18W (2FT) | MX216B-Y20 | 628 x 176 x 65 |
| MX325-Y30 | 935 x 78 x 85 | 30W (3FT) | MX316B-Y30 | 933 x 176 x 65 |
| MX425-Y40 | 1240 x 78 x 85 | 36W (4FT) | MX416B-Y40 | 1238 x 176 x 65 |
| MX625-Y58 | 1540 x 78 x 85 | 56W (5FT) | MX616B-Y58 | 1538 x 176 x 65 |

For spare diffuser add '-DIF' to end of code. Lamps excluded.

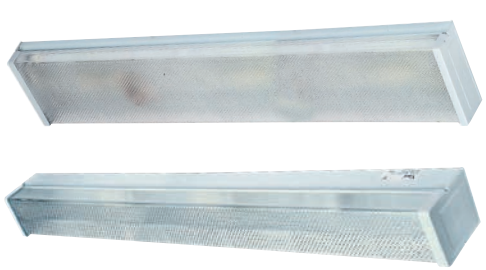

Commercial

LIGHTING

OFFICE FIXTURES

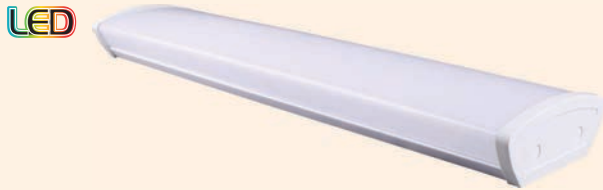

LED Fitting with Curved Opal Diffuser - Integrated LED

| Code | Wattage | Lumens | Size (mm) |
|---------------|---------|--------|-----------------|
| DW-LED-MX-18* | 2 x 9W | 1440lm | 600 x 155 x 65 |
| DW-LED-MX-36* | 2 x 18W | 2880lm | 1200 x 155 x 65 |

*Add Colour to Code: ○ CW (Cool White - 4200K), ○ DL (Day Light - 6000K)

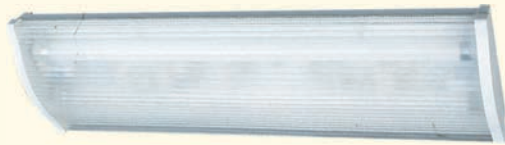

MX472

T8 Fluorescent Fittings with curved Opal Diffuser

| Twin Lamp Code | Lamp Power | Size L x W x H |
|----------------|---------------|-------------------|
| MX472-Y40 | 36W (4FT) x 2 | 1253 x 207 x 69mm |

For spare diffuser add '-DIF' to end of code



MX472B

Fluorescent Fittings with curved Diffuser - Lamps Excluded | c/w Electronic Ballast

| Twin Lamp Code | Lamp Power | Size L x W x H |
|----------------|---------------|-------------------|
| MX472B-Y40 | 36W (4FT) x 2 | 1253 x 207 x 69mm |

For spare diffuser add '-DIF' to end of code.

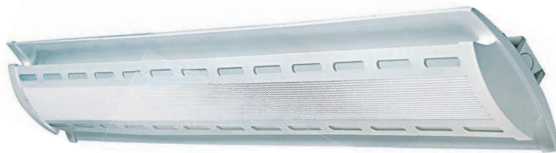

T8 Butterfly Surface Ceiling Fitting - c/w Electronic Ballast | White Powder Coated Steel Body | Lamps Excluded

| Code 2 Lamp | Wattage per Lamp | Lamp Type G13 | Size (mm) L x W x H |
|----------------|---------------------|------------------|------------------------|
| MF-BF9258 | 58W | FLT8-58 | 1563 x 180 x 80 (5FT) |



T8 Super Light Louvre Surface Ceiling Fitting - c/w Electronic Ballast | White Powder Coated Steel Body | Lamps Excluded

| Code | Wattage | Lamp Type | Size |
|-------------|---------|-----------|-----------------------|
| MF-SLM9240V | 36W | FLT8-36 | 1265 x 295 x 85 (4FT) |

T8 OPEN CHANNEL FITTINGS - WIDE BODY

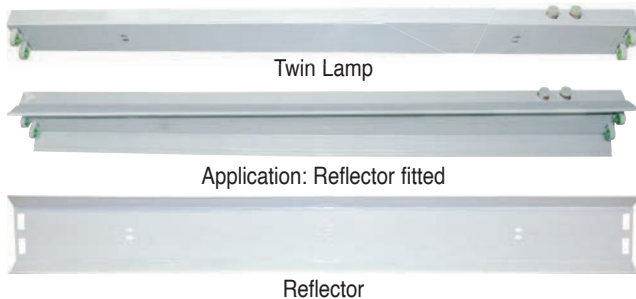

Wide Body Fitting - 100(W) x 38(H)mm

| Code LED | Fluorescent | | | Lamp Power | L (mm) |
|----------------|--------------|----------------|-----------|------------|--------|
| | Iron Ballast | Elec. Ballast | Reflector | | |
| MF-3220-WB-LED | MF-3220-WB | MF-3220-WB-ELC | CZ-3220 | 2x18W(2FT) | 630 |
| MF-3230-WB-LED | MF-3230-WB | MF-3230-WB-ELC | CZ-3230 | 2x30W(3FT) | 935 |
| MF-3240-WB-LED | MF-3240-WB | MF-3240-WB-ELC | CZ-3240 | 2x36W(4FT) | 1240 |
| MF-3258-WB-LED | MF-3258-WB | MF-3258-WB-ELC | CZ-3258 | 2x58W(5FT) | 1540 |

TELESCOPIC OPEN CHANNEL FITTINGS



Wired for LED - Telescopic Open Channel Fitting | Telescopic Lampholders.

| Single Lamp LED | Wattage | Twin Lamp LED | Wattage | Size |
|-----------------|---------|---------------|---------|--------------|
| LED-TS-1X9 | 9W | LED-TS-2X9 | 2 x 9W | 2FT (677mm) |
| LED-TS-1X18 | 18W | LED-TS-2X18 | 2 x 18W | 4FT (1277mm) |
| LED-TS-1X22 | 22W | LED-TS-2X22 | 2 x 22W | 5FT (1577mm) |

Lamps Excluded - For LED Tubes see Page 1-3

Fluorescent - Telescopic Open Channel Fitting | Telescopic Lampholders.

| Single Lamp Elec. Ballast | Size (mm) | Twin Lamp Elec. Ballast | Lamp Power | Size (mm) |
|------------------------------|----------------|----------------------------|------------|-----------------|
| TS-6118 | 677 x 50 x 40 | TS-6218 | 18W (2FT) | 677 x 100 x 38 |
| TS-6136 | 1277 x 50 x 40 | TS-6236 | 36W (4FT) | 1277 x 100 x 38 |
| TS-6158 | 1577 x 50 x 40 | TS-6258 | 58W (5FT) | 1577 x 100 x 38 |

Lamps Excluded - For Fluorescent Tubes see Page 19

Accessories

| Code | Description |
|--------|------------------------------|
| PT-C01 | Spare G13 lampholder per set |

T8 LED OPEN CHANNEL FITTINGS

Prewired Open Channel Fitting for T8 LED Tubes LED Tubes & Fuse Links Excluded

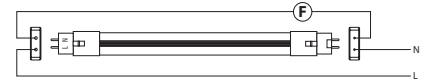

Wiring Diagram

Reflector
CZ-N3140

| Lamp Power | Code (Fitting Only) | | | | Size (mm) |
|------------|---------------------|--------------------|-----------|--------------------|-------------------|
| | Single Lamp | Optional Reflector | Twin Lamp | Optional Reflector | |
| 8W (2FT) | AL-A2 | CZ-3120 | AL-A2X2 | CZ-N3220 | 624L x 35W x 31H |
| 13W (3FT) | AL-A3 | CZ-3130 | AL-A3X2 | CZ-N3230 | 928L x 35W x 31H |
| 18W (4FT) | AL-A4 | CZ-3140 | AL-A4X2 | CZ-N3240 | 1234L x 35W x 31H |
| 22W (5FT) | AL-A5 | CZ-3158 | AL-A5X2 | CZ-N3258 | 1534L x 35W x 31H |

For LED tubes see page 1-3 | For Emergency Add Emergency Tube Code on page 3

Slimline LED T8 Fitting

Prewired for LED

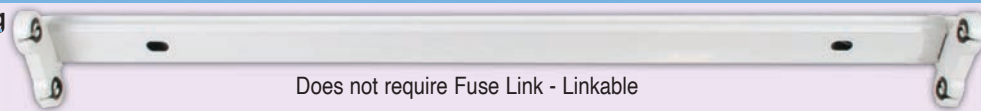

Does not require Fuse Link - Linkable

Side View

| Lamp Power | Code (Fitting Only) | | Size (mm) | Knock Out Size (mm) |
|------------|---------------------|--------------|----------------|---------------------|
| | Single Lamp | Twin Lamp | | |
| 9W (2FT) | OS-LED-006 | OS-LED-006-2 | 610 x 33 x 15 | 7 x 10 |
| 18W (4FT) | OS-LED-012 | OS-LED-012-2 | 1210 x 33 x 15 | 7 x 10 |
| 22W (5FT) | OS-LED-015 | OS-LED-015-2 | 1546 x 33 x 15 | 7 x 10 |



LC-1500

Accessories

| Code | Description |
|---------|------------------------------|
| LC-300 | 300mm Figure 8 Linking Cable |
| LC-1000 | 1m Figure 8 Linking Cable |
| LC-1500 | 1.5m Figure 8 Linking Cable |

For LED tubes see page 1-3 | For Emergency Add Emergency Tube Code on page 3

T8 OPEN CHANNEL FLUORESCENT FITTINGS

Open Fluorescent Fittings

c/w P.F. Capacitor



Twin Lamp

Reflector
CZ-N3140

Narrow Fitting 50(W) x 35(H)mm

Narrow Fitting 50(W) x 35(H)mm

| Lamp Power | Single Lamp | | | | | Twin Lamp | | | | |
|------------|-------------|--------------|---------------|-------------------|-----------|-----------|--------------|---------------|-------------------|-----------|
| | L (mm) | Iron Ballast | Elec. Ballast | c/w Emergency Kit | Reflector | L (mm) | Iron Ballast | Elec. Ballast | c/w Emergency Kit | Reflector |
| 18W (2FT) | 625 | MF-3120 | MF-3120-ELC | - | CZ-3120 | 630 | MF-3220 | MF-3220-ELC | - | CZ-N3220 |
| 30W (3FT) | 930 | MF-3130 | MF-3130-ELC | *MF-3130-EMG | CZ-3130 | 932 | MF-3230 | MF-3230-ELC | *MF-3230-EMG | CZ-N3230 |
| 36W (4FT) | 1240 | MF-3140 | MF-3140-ELC | *MF-3140-EMG | CZ-3140 | 1235 | MF-3240 | MF-3240-ELC | *MF-3240-EMG | CZ-N3240 |
| 58W (5FT) | 1540 | MF-3158 | MF-3158-ELC | *MF-3158-EMG | CZ-3158 | 1535 | MF-3258 | MF-3258-ELC | *MF-3258-EMG | CZ-N3258 |

*1 Lamp fitted with Emergency Kit @ 11% of full power for 1 hour @ 58W

For dimmable light fitting add 'dim' to part No. eg. MF-3140-DIM. Note dimmable units to work with correct external dimmer module EP1 / DS2F see page 158



PT-C07

PT-C02

Accessories - For spare ballasts see page 157-159

| Code | Description |
|--------|-------------------------------------------|
| PT-C07 | Spare lampholder for twin-lamp fittings |
| PT-C02 | Spare lampholder for single-lamp fittings |

T5 OPEN CHANNEL FLUORESCENT FITTINGS

Open Fluorescent Fittings - Supplied with electronic ballasts

Double Lamp

Single Lamp



| Lamp Power | Single Lamp | | | Twin Lamp | | |
|------------|------------------|-------------------|------------------|------------------|-------------------|------------------|
| | Code | c/w Emergency Kit | Size L x W x H | Code | c/w Emergency Kit | Size L x W x H |
| 14W(2ft) | MF-5114-ELC 240V | - | 579 x 50 x 70mm | MF-5214-ELC 240V | - | 579 x 50 x 70mm |
| 21W(3ft) | MF-5121-ELC 240V | - | 879 x 50 x 70mm | MF-5221-ELC 240V | - | 879 x 50 x 70mm |
| 28W(4ft) | MF-5128-ELC 240V | MF-5128-EMG | 1179 x 50 x 70mm | MF-5228-ELC 240V | MF-5228-EMG | 1179 x 50 x 70mm |
| 35W(5ft) | MF-5135-ELC 240V | MF-5135-EMG | 1479 x 50 x 70mm | MF-5235-ELC 240V | MF-5235-EMG | 1479 x 50 x 70mm |
| 24W(2ft) | MF-5124-ELC 240V | - | 579 x 50 x 70mm | MF-5224-ELC 240V | - | 579 x 50 x 70mm |
| 54W(4ft) | MF-5154-ELC 240V | MF-5154-EMG | 1179 x 50 x 70mm | MF-5254-ELC 240V | - | 1179 x 50 x 70mm |
| 49W(5ft) | MF-5149-ELC 240V | MF-5149-EMG | 1479 x 50 x 70mm | MF-5249-ELC 240V | MF-5249-EMG | 1479 x 50 x 70mm |

LED RECESSED PANELS IP40

NEW 3 Year Warranty



P0606

Backlit Panel - Input Voltage: 100-240VAC | High Quality | Ultra Efficient | Low Glare | PMMA Diffuser | Suspension Kit available under Accessories

| Code 3 Year | Wattage | Lumen | Size (mm) | Spare Driver |
|-----------------|---------|--------|-----------------|--------------|
| DFL-P0606-40W-* | 40W | 4400lm | 595 x 595 x 30 | DRV-DFL-40W |
| DFL-P0606-64W-* | 64W | 7040lm | 595 x 595 x 30 | DRV-DFL-64W |
| DFL-P1203-40W-* | 40W | 4000lm | 1195 x 300 x 30 | DRV-DFL-40W |
| DFL-P1206-64W-* | 64W | 7040lm | 1195 x 595 x 30 | DRV-DFL-64W |

* Add colour to code: ○ CW (Cool White) 4200K, ○ DL (Daylight) 6000K

3 Year Warranty

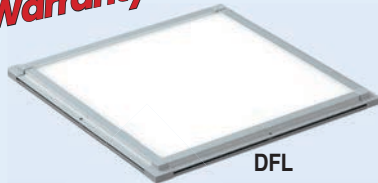

DFL



DIM-DFL

Sidelit Panel - 3 Year Warranty panels are designed for normal operating conditions at 8hrs a day. It is recommended to use the 5 Year Warranty panels for operating hours above 8hrs. Warranty void if panels are incorrectly specified for the application.

| Code | Wattage | Lumen | Size (mm) | Spare Driver |
|--------------------------------------------------------------------------------|---------|--------|-----------------|--------------|
| Standard - Supply Voltage: 100-240VAC CRI > 80 Lumen Output 100lm/W | | | | |
| DFL-P0303-* | 21W | 2100lm | 300 x 300 x 12 | DRV-DFL-21W |
| DFL-P0606-72W-CW | 72W | 7200lm | 595 x 595 x 12 | DRV-DFL-72W |
| DFL-P1203-CW | 52W | 5200lm | 1195 x 300 x 12 | DRV-DFL-52W |

Dimmable - Supply Voltage: 100-240VAC | Panels have a 1-10V input on driver (use GL-CA-1 Dimmer)

| Code | Wattage | Lumen | Size (mm) | Spare Driver |
|---------------------|---------|--------|-----------------|-----------------|
| DIM-DFL-P0303-* | 21W | 2100lm | 300 x 300 x 12 | DIM-DRV-DFL-21W |
| DIM-DFL-P0606-40W-* | 52W | 5200lm | 1195 x 300 x 12 | DIM-DRV-DFL-52W |
| DIM-DFL-P1203-* | 72W | 7200lm | 1195 x 595 x 12 | DIM-DRV-DFL-72W |
| DIM-DFL-P1206-72W-* | 40W | 4000lm | 595 x 595 x 12 | DIM-DRV-DFL-40W |

* Add colour to code: ○ CW (Cool White) 4200K, ○ DL (Daylight) 6000K

5 Year Warranty

125 lm/w



High Performance - Input Voltage: 100-277VAC | High Quality, Optimal Performance | CRI > 80 | Lumen Output 125lm/W | Flicker Free | Light Guide Plates PMMA | PF 0.95 | IP20

| Codes | Wattage | Lumen | Size (mm) | Spare Driver |
|----------------|---------|--------|-----------------|--------------|
| FN-0606-40W-* | 40W | 5000lm | 595 x 595 x 10 | DRV-FN-40W |
| FN-60120-50W-* | 50W | 6250lm | 595 x 1195 x 10 | DRV-FN-50W |

* Add colour to code: ○ CW (Cool White) 4200K, ○ DL (Daylight) 6000K

NEW



Splicing Frame Panel Light - Input Voltage: 220-240VDC | CRI>80 | Material: PC | High Light Output | Surface or Recess Mount | Elegant Design

| Code | Wattage | Lumen | Size (mm) |
|-------------------|---------|--------|----------------|
| SEC-L-PL225-36W-* | 36W | 2600lm | 595 x 595 x 20 |
| SEC-L-PL225-40W-* | 40W | 4000lm | 595 x 595 x 20 |
| SEC-L-PL225-48W-* | 48W | 4800lm | 595 x 595 x 20 |

* Add colour to code: ○ CW (Cool White) 4200K, ○ DL (Daylight) 6000K

3 Year Warranty



DALI Dimmable LED Panel - Input Voltage: 180-265VAC | CRI >80 | Beam Angle 120° | Meanwell DALI Dimmable Driver

| Codes | Wattage | Lumen | Size (mm) | Spare Driver |
|------------------|---------|--------|------------|--------------|
| DALI-DFL-P0606-* | 40W | 4000lm | 595 x 595 | DRV-DFL-40W |
| DALI-DFL-P1206-* | 60W | 6000lm | 1195 x 595 | DRV-DFL-60W |

* Add colour to code: ○ CW (Cool White) 4200K, ○ DL (Daylight) 6500K

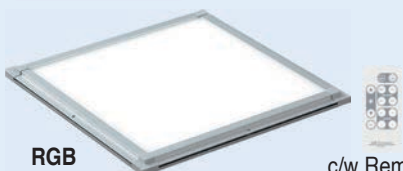

RGB

c/w Remote

RGB - Supply Voltage: 100-240VAC | ●●● RGB | c/w Remote

| Codes | Wattage | Lumen | Size (mm) | Spare Driver |
|-------------------|---------|--------|----------------|-----------------|
| DFL-P0606-46W-RGB | 46W | 3220lm | 595 x 595 x 50 | DRV-DFL-46W-RGB |

LED RECESSED PANELS

**2 Year
Warranty**

Daylight Harvesting - Input Voltage: 100-277VAC | Beam Angle 80° | UGR 19 | CRI > 80 | Built in daylight sensor to sense movement & calculate ambient light to automatically adjust light output to set parameters

| Code | Wattage | Lumens | Size (mm) |
|-----------|---------|--------|----------------|
| PL-0606-* | 40W | 3790lm | 595 x 595 x 44 |

* Add colour to code: ○ CW (Cool White) 4200K, ○ DL (Daylight) 6000K

Accessories

| Code | Description |
|--------|---------------------------------------|
| PL-RMC | Remote Control for setting Parameters |

**2 Year
Warranty**

GL-42-R-*

GL-42-S-*

Decorative Recessed LED Panel IP20 - Input Voltage: 230VAC | Body Construction ABS | Opal Diffuser | White Trim Colour | CRI: +80

| Code | Wattage | Lumen | Size (mm) | Inner Shape |
|-----------|---------|--------|-----------------|-------------|
| GL-42-R-* | 42W | 4368lm | 595 x 595 x 100 | Round |
| GL-42-S-* | 42W | 4368lm | 595 x 595 x 100 | Square |

* Add colour to code: ○ CW (Cool White) 4200K, ○ DL (Daylight) 6000K

**2 Year
Warranty**

LED Emergency Panel IP40 - Input Voltage: 230VAC | 1hr Backup time - Half power during backup | Green light - Main line, Red light - Charging, Yellow light - Error | Ni-MH Rechargeable battery

| Codes | Wattage | Lumen | Size (mm) |
|---------------------|---------|--------|------------|
| EMG-DFL-P0606-40W-* | 40W | 4000lm | 595 x 595 |
| EMG-DFL-P1206-60W-* | 50W | 5000lm | 1195 x 595 |

* Add colour to code: ○ CW (Cool White) 4200K, ○ DL (Daylight) 6500K

Dimmer

GL-CA-1



SF-300

 GL-CA-4KIT
GL-CA-6KIT

SM4-6060

SM4-60120

Accessories

| Code | Description |
|------------|-------------------------------------------------------|
| SF-300 | 2m 0.75 x 3 Core Cable with 5Amp Plug |
| GL-CA-4KIT | 4 Pcs of wire for 300x300 or 600x600 panels |
| GL-CA-6KIT | 6 Pcs of wire for 1200x300 or 1200x600 panels |
| GL-CA-1 | Up to 144W (230VAC) 1-10V Output (No Max Load) |
| SM4-6060 | 595 x 595 x 10mm Surface Mount Bracket for LED Panel |
| SM4-60120 | 595 x 1195 x 10mm Surface Mount Bracket for LED Panel |
| DFL-4H | Suspension bracket for 600x600 backlit panel |
| DFL-6H | Suspension bracket for 1200x600 backlit panel |

Commercial

LED RECESSED FITTINGS

**5 Year
Warranty**

FX-ZMP-12X6

FX-ZMP-6X6

Recessed Indirect Fitting - Input Voltage: 85-265VAC | Integrated LEDs

| Codes | Wattage | Lumen | Size (mm) |
|---------------|---------|--------|-----------------|
| FX-ZMP-6X6-* | 46W | 4600lm | 595 x 595 x 95 |
| FX-ZMP-12X3-* | 53W | 5300lm | 1195 x 295 x 95 |
| FX-ZMP-12X6-* | 53W | 5300lm | 1195 x 595 x 95 |

* Add colour to code: ○ CW (Cool White) 4200K, ○ DL (Daylight) 6500K

LED Tubes & Fuse Links Excluded



LED-66143

LED-66123

Recessed Fitting with Prismatic Diffuser - Wired for T8 LED tubes

| Code | No. of Lamps/ Power | Size (mm) L x W x H |
|-------------|---------------------|---------------------|
| LED-66123 | 3 x 2FT | 595 x 595 x 90 |
| LED-66123P4 | 4 x 2FT | 595 x 595 x 90 |
| LED-66143 | 3 x 4FT | 595 x 1195 x 90 |
| LED-66143P4 | 4 x 4FT | 595 x 1195 x 90 |

For LED tubes see page 1-3 | For Emergency Add Emergency Tube Code on page 3

LED Tubes & Fuse Links Excluded



LED-8143P3

LED-8123P3

Recessed Fitting Aluminium Parabolic Louvre - Wired for T8 LED tubes

| Code | No. of Lamps/ Power | Size (mm) L x W x H |
|------------|---------------------|---------------------|
| LED-8123P3 | 3 x 2FT | 595 x 595 x 90 |
| LED-8123P4 | 4 x 2FT | 595 x 595 x 90 |
| LED-8143P3 | 3 x 4FT | 595 x 1195 x 90 |
| LED-8143P4 | 4 x 4FT | 595 x 1195 x 90 |

LED T8 SURFACE FITTINGS



LED T8 Steel Surface Mount IP20 - V-Shaped Louvre Grill l c/w Fuse Links l Pre-wired for LED Tube

| Code | T8 Lamp | Size (mm) |
|--------------|---------|-----------------|
| LED-ETL240VG | 2 x 18W | 1250 x 303 x 68 |

T8 RECESSED FLUORESCENT FITTINGS

Recessed Fittings Aluminium Parabolic Louvre c/w P.F. Capacitor - Emergency Kit fitted @ 12% of full power for 3 hours @ 36W l Lamps excluded l Hinged Reflector for easy maintenance

| Code | No. of Lamps/Power | Size (mm) L x W x H | 1 Lamp fitted with EMG kit |
|--------------|--------------------|---------------------|----------------------------|
| SF-8123P3* * | 3 x 18W (2FT) | 595 x 595 x 90 | SF-8123P3-EMG |
| SF-8123P4* | 4 x 18W (2FT) | 595 x 595 x 90 | SF-8123P4-EMG |
| SF-8143P3* * | 3 x 36W (4FT) | 595 x 1195 x 90 | SF-8143P3-EMG |
| SF-8143P4* | 4 x 36W (4FT) | 595 x 1195 x 90 | SF-8143P4-EMG |

*For electronic ballast add -ELC. * For 2m cord set add SF to code

| Accessories Code | Description |
|------------------|------------------------------------------------|
| SF-300 | 2 meter 0.75 x 3 core cable with 5 Amp Plug |
| SF-305 | 3 meter 0.75 x 3 core cable with 5 Amp Plug |
| SF-304 | Assembly of 2 meter cable to light fitting |
| SF-8143P3-DIF | Spare 1200 x 600 Aluminium Parabolic Reflector |
| SF-8143P4-DIF | Spare 1200 x 600 Aluminium Parabolic Reflector |
| PT-C08 | Lamp holder |

Recessed Fittings Prismatic Diffuser c/w P.F. Capacitor - Emergency Kit fitted @ 12% of full power for 3 hours @ 36W l Lamps excluded.

| Code | No. of Lamps/Power | Size (mm) L x W x H | 1 Lamp fitted with EMG kit |
|-------------|--------------------|---------------------|----------------------------|
| SF-66123* | 3 x 18W (2FT) | 595 x 595 x 90 | SF-66123-EMG |
| SF-66123P4* | 4 x 18W (2FT) | 595 x 595 x 90 | SF-66123P4-EMG |
| SF-66143* | 3 x 36W (4FT) | 595 x 1195 x 90 | SF-66143-EMG |
| SF-66143P4* | 4 x 36W (4FT) | 595 x 1195 x 90 | SF-66143P4-EMG |

*For electronic ballast add -ELC

| Accessories Code | Description |
|------------------|-----------------------------------------------|
| SF-300 | 2 meter 0.75 x 3 core cable with 5 Amp Plug |
| SF-304 | Assembly of 2 meter cable to light fitting |
| SF-8123-DIF | Spare 600 x 600 Aluminium Parabolic Reflector |
| SF-66123-DIF | Spare 600 x 600 Prismatic Diffuser |
| SF-66143-DIF | Spare 1200 x 600 Prismatic Diffuser |
| PT-C08 | Lamp Holder |

T5 RECESSED FLUORESCENT FITTINGS

SK-T5L328
SK-T5L354



T5 Recessed Double Parabolic Light Fittings With Electronic Ballasts l Lamps excluded

| Size (mm) L x W x H | Code 2 Lamp | Code 3 Lamp | | Code 4 Lamp | Wattage per Lamp | Lamp Type G5 |
|---------------------|-------------|-------------|-----------------|-------------|------------------|--------------|
| | | Normal | 90min Emergency | | | |
| 600 x 600 x 60 | - | - | - | SK-T5L414 | 14W | FLT5-14 |
| 1200 x 295 x 60 | T5-T1142R | - | - | - | 28W | FLT5-28 |
| 1200 x 600 x 60 | SK-T5L228 | SK-T5L328 | SK-T5L328-EMG | - | 28W | FLT5-28 |
| 1200 x 600 x 60 | - | SK-T5L354 | - | - | 54W | FLT5-54 |

Accessories

| Code | Description |
|---------------|--------------------------------------------|
| SK-T5L228-DIF | Spare Aluminium Louvre for SK-T5L228 |
| SK-T5L314-DIF | Spare Aluminium Louvre for SK-T5L314 |
| SK-T5L328-DIF | Spare Aluminium Louvre for SK-T5L328 |
| SF-300 | 2 Meter 0.75 x 3 Core Cable with Samp Plug |
| SF-305 | 3 Meter 0.75 x 3 Core Cable with Samp Plug |
| SF-304 | Assembly of 2 Meter Cable to Light Fitting |

Recessed Fitting - White l With Electronic Ballast 230VAC l Double reflector system provides soft and glare-free lighting l Energy saving l Elegant and modern design l Lamps excluded. For Lamps see page 19

| Code | No. of Lamps/Power | Size (mm) L x W x H |
|---------|--------------------|---------------------|
| TCH-214 | 2 x 14W | 595 x 595 x 90 |
| TCH-220 | 2 x 28W | 1195 x 595 x 90 |

RECESSED PLL FITTINGS



PLL Recessed Parabolic Light Fittings c/w Electronic Ballasts for 2 x 55W(2G11)
| Elec. Transformer 230/12V 150VA for 3 x AR111 (included) | Lamps Excluded

| Size (mm) L x W x H | 2 x 55W (T5) 3 x AR111 | Lamp Type 2G11 |
|------------------------|---------------------------|-------------------|
| 600 x 600 x 60 | SF-0755G | NB5025-55 |



PLL Recessed Parabolic Fitting c/w Electronic Ballast | Lamps Excluded

| Size (mm) L x W x H | Code 3 Lamp | Wattage per Lamp | Lamp Type 2G11 |
|------------------------|----------------|---------------------|-------------------|
| 595 x 595 x 90 | SF-366-ELC | 36W | NB5025-36 |
| 595 x 595 x 85 | SF-8355 | 55W | NB5025-55 |



PLL Recessed Glider Fitting c/w Magnetic Ballast | Lamps Excluded

| Size (mm) L x W x H | Code 3 Lamp | Wattage per Lamp | Lamp Type 2G11 |
|------------------------|----------------|---------------------|-------------------|
| 595 x 595 x 111 | SF-86236V | 36W | NB5025-36 |

T8 SURFACE FLUORESCENT FITTINGS

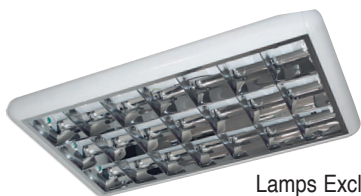

Lamps Excluded

T8 Steel Surface Ceiling Light Fitting c/w Electronic Ballasts | V-Shaped Louvre Grill

| Size (mm) L x W x H | Code 3 Lamp | Wattage per Lamp | Lamp Type G13 |
|------------------------|----------------|---------------------|------------------|
| 695 x 425 x 68 (2FT) | SK-ETL320VG | 18W | FLT8-18 |

T5 SURFACE FLUORESCENT FITTINGS

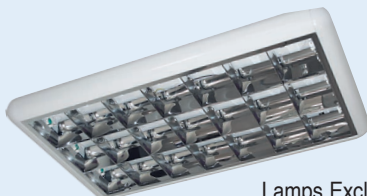

Lamps Excluded

T5 Steel Surface Ceiling Light Fitting c/w Electronic Ballasts | V-Shaped Louvre Grill

| Size (mm) L x W x H | Code 3 Lamp | Wattage per Lamp | Lamp Type G5 |
|------------------------|----------------|---------------------|-----------------|
| 660 x 425 x 68 (2FT) | SK-ETL314VG | 3 x 14W | FLT5-14 |

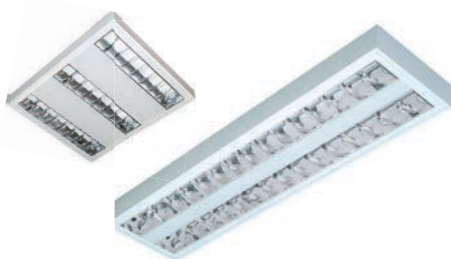

T5 Surface Double Parabolic Light Fittings With Electronic Ballasts | Lamps Excluded

| Size (mm) L x W x H | Code 2 Lamp | Code 3 Lamp | Wattage per Lamp | Lamp Type G5 |
|------------------------|----------------|----------------|---------------------|-----------------|
| 600 x 600 x 60 | - | MF-T5314 | 14W | FLT5-14 |
| 1200 x 295 x 60 | T5-T1142S | - | 28W | FLT5-28 |
| 1200 x 295 x 60 | T5-T254S | - | 54W | FLT5-54 |

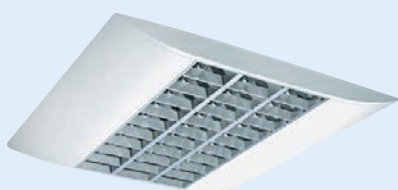

T5 Surface Fluorescent Louvre With Electronic Ballasts | Lamps Excluded

| Size (mm) L x W x H | Code 3 Lamp | Wattage per Lamp | Lamp Type G5 |
|------------------------|----------------|---------------------|-----------------|
| 623 x 623 x 66 | SK-STL314 | 14W | FLT5-14 |
| 1227 x 623 x 66 | SK-STL328 | 28W | FLT5-28 |
| 1227 x 623 x 66 | SK-STL354 | 54W | FLT5-54 |

SURFACE PLL FLUORESCENT FITTINGS



PLL Owl Surface Ceiling Fitting c/w Magnetic Ballast | Lamps excluded. For lamps see page 19

| Size (mm) L x W x H | Code 2 Lamp | Wattage per Lamp | Lamp Type 2G11 |
|------------------------|----------------|---------------------|-------------------|
| 585 x 550 x 64 | MF-OW236 | 36W | NB5025-36 |

RECESSED LED DOWNLIGHTS

Dimmable

- WW - 2700K
- CW - 4200K
- PW - 5000K

5 Year Warranty



Super Slim Design IP54 - Input Voltage: 230VAC | Triac Dimmable | CRI ≥ 80 | Class II Protection | IK06 Rating | Material PC / Aluminium | Lifetime 50 000hrs | Operating Temp: -20°C - 45°C

| Code | Wattage | Lumens (lm) | Cut out Size (mm) | Size (mm) | Beam Angle | *Add Colour to Code |
|----------------|---------|-------------|-------------------|-----------|------------|---------------------|
| UP-DL210-10W-* | 10W | 760 - 870 | Ø90 - 95 | Ø110 x 30 | 90° | WW / CW / PW |
| UP-DL210-13W-* | 13W | 1020 - 1140 | Ø120 - 130 | Ø145 x 30 | 90° | WW / CW / PW |
| UP-DL210-18W-* | 18W | 1620 - 1800 | Ø160 - 170 | Ø190 x 30 | 90° | WW / CW / PW |
| UP-DL210-25W-* | 25W | 2130 - 2380 | Ø200 - 210 | Ø225 x 34 | 90° | WW / CW / PW |

- WW - 2700K
- CW - 4200K
- PW - 5000K

5 Year Warranty



Deep Reflector IP54 - Input Voltage: 230VAC | Triac Dimmable | CRI ≥ 80 | Class II Protection | IK06 Rating | Material PC / Aluminium | Lifetime 50 000hrs | Operating Temp: -20°C - 45°C

| Code | Wattage | Lumens (lm) | Cut out Size (mm) | Size (mm) | Beam Angle | *Add Colour to Code |
|----------------|---------|-------------|-------------------|-----------|------------|---------------------|
| UP-DL179-10W-* | 10W | 700 - 800 | Ø90 - 95 | Ø110 x 54 | 80° | WW / CW / PW |
| UP-DL179-18W-* | 18W | 1600 - 1800 | Ø125 - 135 | Ø145 x 78 | 80° | WW / CW / PW |
| UP-DL179-25W-* | 25W | 2300 - 2550 | Ø150 - 165 | Ø172 x 90 | 80° | WW / CW / PW |

- WW - 2700K
- CW - 4200K
- PW - 5000K

5 Year Warranty



COB High Power IP54 - Input Voltage: 230VAC | Triac Dimmable | CRI ≥ 80 | Class II Protection | IK06 Rating | Aluminium Reflector + Tempered Glass Lens | Lifetime 50 000hrs | Operating Temp: -20°C - 40°C

| Code | Wattage | Lumens (lm) | Cut out Size (mm) | Size (mm) | Beam Angle | *Add Colour to Code |
|------------------|---------|-------------|-------------------|-----------|------------|---------------------|
| UP-DL229-10W-* | 10W | 760 - 988 | Ø90 - 95 | Ø110 x 35 | 60° | WW / CW / PW |
| UP-DL229-18W-S-* | 18W | 1500 - 1997 | Ø120 - 130 | Ø145 x 65 | 60° | WW / CW / PW |
| UP-DL229-18W-L-* | 18W | 1600 - 2066 | Ø200 - 210 | Ø225 x 87 | 60° | WW / CW / PW |
| UP-DL229-25W-* | 25W | 2200 - 2801 | Ø200 - 210 | Ø225 x 87 | 60° | WW / CW / PW |
| UP-DL229-42W-* | 42W | 3050 - 3659 | Ø200 - 210 | Ø225 x 87 | 60° | WW / CW / PW |

- CW - 4200K
- PW - 5000K

5 Year Warranty



Gimble Head IP20 - Input Voltage: 230VAC | Triac Dimmable | CRI ≥ 80 | Class II Protection | IK06 Rating | PC Reflector + Tempered Glass | Lifetime 50 000hrs | Operating Temp: -20°C - 40°C

| Code | Wattage | Lumens (lm) | Cut out Size (mm) | Size (mm) | *Beam Angle | *Add Colour to Code |
|------------------|---------|-------------|-------------------|--------------|-------------|---------------------|
| UP-DL77-10W-**-* | 10W | 700 - 800 | Ø85 - 90 | Ø96 x 68 | 15, 24 | CW / PW |
| UP-DL77-20W-**-* | 20W | 1840 - 2100 | Ø120 - 130 | Ø145 x 102 | 36, 60 | CW / PW |
| UP-DL77-35W-**-* | 35W | 3350 - 3800 | Ø165 - 170 | Ø180 x 128.5 | 45, 60 | CW / PW |

- WW - 2700K
- CW - 4200K



White / Silver Trim Downlight - Input Voltage: 100-240VAC | Ultra Thin | Beam Angle 110° | Triac Dimmable

| Code | Wattage | Lumens | Cut out Size (mm) | Material/ Colour | Size (mm) | *Add Colour to Code |
|--------------|---------|--------|-------------------|------------------|-----------|---------------------|
| GL-P9WA-**-* | 9W | 720lm | Ø135 | White/Silver | 145Ø x 14 | WW / CW |
| GL-P12WA-* | 12W | 960lm | Ø155 | Silver | 170Ø x 14 | WW / CW |
| GL-P16WA-* | 16W | 1280lm | Ø185 | Silver | 200Ø x 14 | WW / CW |
| GL-P20WA-* | 20W | 1600lm | Ø210 | Silver | 220Ø x 14 | WW / CW |

*Add WH to code for white trim

- WW - 2700K
- CW - 4200K
- DL - 6000K



Glass Trim Downlight - Input Voltage: 100-240VAC | Beam Angle 110° | Triac Dimmable

| Code | Wattage | Lumens | Cut out Size (mm) | Material/ Colour | Size (mm) | *Add Colour to Code |
|--------------------|---------|--------|-------------------|------------------|-----------|---------------------|
| DIM-DL-RN100-6W-* | 6W | 400lm | Ø75 | White | Ø100 x 28 | WW / CW / DL |
| DIM-DL-RN160-12W-* | 12W | 800lm | Ø120 | White | Ø160 x 30 | WW / CW / DL |

- WW - 2700K
- CW - 4200K



Input Voltage: 230VAC | Beam Angle: 90° | TRIAC Dimming

| Code | Wattage | Lumens | Cut out Size (mm) | Material/ Colour | Size (mm) | *Add Colour to Code |
|--------------|---------|--------|-------------------|------------------|-----------|---------------------|
| HI-015-6W-* | 6W | 510lm | Ø120 | White | Ø145 x 74 | WW / CW |
| HI-015-12W-* | 12W | 1020lm | Ø120 | White | Ø145 x 74 | WW / CW |
| HI-015-15W-* | 15W | 1300lm | Ø120 | White | Ø145 x 74 | WW / CW |

SURFACE MOUNT LED DOWNLIGHTS

Non-Dimmable

- WW - 2700K
- CW - 4200K

- *W - White
- *B - Black



Input Voltage: 185-265VAC | Aluminium | Beam Angle: 45°

| Code | Wattage | Lumens | Cut out Size (mm) | Material/ Colour | Size (mm) | *Add Colour to Code |
|---------------|---------|--------|-------------------|------------------|------------|---------------------|
| COB-SM*-10W-* | 10W | 800lm | - | *W / B | Ø90 x 124 | WW / CW |
| COB-SM*-20W-* | 20W | 1300lm | - | *W / B | Ø115 x 145 | WW / CW |
| COB-SM*-30W-* | 30W | 1950lm | - | *W / B | Ø149 x 165 | WW / CW |

Input Voltage: 185-285VAC | Back Lit | Beam Angle: 140°



| | | | | | | |
|----------------|-----|--------|---|-------|----------------|---------|
| SM-RN120-6W-* | 6W | 420lm | - | White | Ø123 x 35 | WW / CW |
| SM-RN170-12W-* | 12W | 960lm | - | White | Ø174 x 35 | WW / CW |
| SM-RN225-18W-* | 18W | 1620lm | - | White | Ø226 x 35 | WW / CW |
| SM-SQ120-6W-* | 6W | 420lm | - | White | 122 x 122 x 35 | WW / CW |
| SM-SQ172-12W-* | 12W | 960lm | - | White | 173 x 173 x 35 | WW / CW |
| SM-SQ225-18W-* | 18W | 1620lm | - | White | 226 x 226 x 35 | WW / CW |

2 IN 1 SURFACE AND RECESSED LED DOWNLIGHTS

Non-Dimmable

- WW - 2700K
- CW - 4200K
- DL - 6000K



Motion & Daylight Sensor LED Panel - Input Voltage: 230VAC | Detection Height 3,5m | Hold Time 30s | Moon Mode: Both motion sensor & light sensor work when indoor illumination < 13 lux. Sun Mode: Only motion sensor works (day or night). Trim rings available in various colours.

| Code | Wattage | Lumens | Cut out Size (mm) | Material/ Colour | Size (mm) | *Add Colour to Code |
|----------------|---------|--------|-------------------|------------------|-----------|---------------------|
| MD-RN220-18W-* | 18W | 1500lm | - | White | Ø220 x 18 | WW / CW / DL |
| MD-SQ220-18W-* | 18W | 1500lm | - | White | 220 x 220 | WW / CW / DL |

Round Trim Ring Colours – MD-RN220-TR-BK (Black), MD-RN220-TR-GD (Gold), MD-RN220-TR-S (Silver)
 Square Trim Ring Colours – MD-SQ220-TR-BK (Black), MD-SQ220-TR-GD (Gold), MD-SQ220-TR-S (Silver)

NEW

RECESSED/SURFACE DOWNLIGHTS

Recessed or Surface Downlights - Input Voltage: 230VAC | Beam Angle 120° | Purchase Frame to Surface Mount

| Code | Wattage | Lumens | Cut out Size (mm) | Material/ Colour | Size (mm) | *Add Colour to Code |
|-------------|---------|--------|-------------------|------------------|------------------|---------------------|
| RN-WM-6W-* | 6W | 600lm | Ø100 - 110 | White | Ø117 x 25.8 | WW / CW / DL |
| RN-WM-9W-* | 9W | 900lm | Ø125 - 135 | White | Ø147 x 25.8 | WW / CW / DL |
| RN-WM-12W-* | 12W | 1200lm | Ø140 - 160 | White | Ø167 x 25.8 | WW / CW / DL |
| RN-WM-18W-* | 18W | 1850lm | Ø195 - 210 | White | Ø222 x 25.8 | WW / CW / DL |
| SQ-WM-6W-* | 6W | 600lm | Ø100 - 110 | White | 117 x 117 x 25.8 | WW / CW / DL |
| SQ-WM-9W-* | 9W | 900lm | Ø125 - 135 | White | 147 x 147 x 25.8 | WW / CW / DL |
| SQ-WM-12W-* | 12W | 1200lm | Ø140 - 160 | White | 167 x 167 x 25.8 | WW / CW / DL |
| SQ-WM-18W-* | 18W | 1850lm | Ø195 - 210 | White | 222 x 222 x 25.8 | WW / CW / DL |

Accessories - Surface Mount Frame

| Code | Description | Code | Description |
|-------------|-----------------|-------------|------------------|
| RN-WM-6W-F | Round Frame 6W | SQ-WM-6W-F | Square Frame 6W |
| RN-WM-9W-F | Round Frame 9W | SQ-WM-9W-F | Square Frame 9W |
| RN-WM-12W-F | Round Frame 12W | SQ-WM-12W-F | Square Frame 12W |
| RN-WM-18W-F | Round Frame 18W | SQ-WM-18W-F | Square Frame 18W |



RECESSED LED DOWNLIGHTS

Non-Dimmable



NEW

Frameless Downlight - Input Voltage: 185-265VAC | 110° Beam Angle | CRF >70 | Adjustable Clip for Various Hole Sizes

| Code | Wattage | Lumens | Cut-out Size (mm) | Material/Colour | Size (mm) | *Add Colour to Code |
|-------------|---------|--------|-------------------|-----------------|-----------|---------------------|
| FD-RN-9W-* | 8W | 800lm | Ø50-70 | White | Ø85 | WW / CW / DL |
| FD-RN-18W-* | 18W | 1800lm | Ø50-100 | White | Ø120 | WW / CW / DL |
| FD-RN-24W-* | 24W | 2400lm | Ø50-150 | White | Ø170 | WW / CW / DL |
| FD-RN-36W-* | 36W | 3600lm | Ø50-200 | White | Ø220 | WW / CW / DL |
| FD-SQ-9W-* | 8W | 800lm | 75 x 70 | White | 85 x 85 | WW / CW / DL |
| FD-SQ-18W-* | 18W | 1800lm | 100 x 100 | White | 120 x 120 | WW / CW / DL |
| FD-SQ-24W-* | 24W | 2400lm | 150 x 150 | White | 170 x 170 | WW / CW / DL |
| FD-SQ-36W-* | 36W | 3600lm | 200 x 200 | White | 220 x 220 | WW / CW / DL |

- WW - 2700K
- CW - 4200K
- DL - 6000K

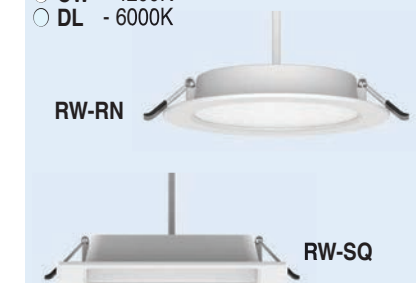

White Trim Downlight - Input Voltage: 185-265VAC | Black Lit | 25,5mm depth | Beam Angle 140° | CRI > 70

| | | | | | | |
|----------------|-----|--------|-----------|-------|-----------|--------------|
| RW-RN120-6W-* | 6W | 390lm | Ø95 | White | Ø118 | WW / CW / DL |
| RW-RN150-9W-* | 9W | 630lm | Ø110 | White | Ø145 | WW / CW / DL |
| RW-RN170-12W-* | 12W | 900lm | Ø140 | White | Ø175 | WW / CW / DL |
| RW-RN200-18W-* | 18W | 1530lm | Ø190 | White | Ø222 | WW / CW / DL |
| RW-SQ120-6W-* | 6W | 420lm | 95 x 95 | White | 120 x 120 | WW / CW / DL |
| RW-SQ150-9W-* | 9W | 675lm | 110 x 110 | White | 145 x 145 | WW / CW / DL |
| RW-SQ170-12W-* | 12W | 960lm | 140 x 140 | White | 175 x 175 | WW / CW / DL |
| RW-SQ220-18W-* | 18W | 1620lm | 190 x 190 | White | 224 x 224 | WW / CW / DL |

- WW - 2700K
- CW - 4200K
- DL - 6000K

EMG **NEW**

White Trim Emg Downlight - Input Voltage: 230VAC | RA 80 | 120° Beam Angle | 2500 mAh Li-ion Battery | Emergency Lumen: 250lm | Emergency 2-3hrs | Full Charge 6-8hrs

| | | | | | | |
|------------------|-----|-------|------|------------|-----------|--------------|
| RW-SPL-EMG-12W-* | 12W | 960lm | Ø155 | Pc White | Ø180 x 21 | WW / CW / DL |
|------------------|-----|-------|------|------------|-----------|--------------|



- WW - 2700K
- CW - 4200K
- DL - 6000K

NEW

LED Panel with Integrated Driver - Input Voltage: 175-265VAC | Aluminium & Plastic | Beam Angle 110°

| | | | | | | |
|----------------|-----|--------|-----------|-------|-----------|--------------|
| RN-RW04-R6W-* | 6W | 300lm | Ø75 | White | Ø90 | WW / CW / DL |
| RN-RW04-R12W-* | 12W | 780lm | Ø100 | White | Ø120 | WW / CW / DL |
| RN-RW04-R16W-* | 16W | 1040lm | Ø150 | White | Ø170 | WW / CW / DL |
| RN-RW04-R24W-* | 24W | 1560lm | Ø200 | White | Ø225 | WW / CW / DL |
| SQ-RW04-R6W-* | 6W | 300lm | 75 x 75 | White | 90 x 90 | WW / CW / DL |
| SQ-RW04-R12W-* | 12W | 780lm | 100 x 100 | White | 120 x 120 | WW / CW / DL |
| SQ-RW04-R16W-* | 16W | 1040lm | 150 x 150 | White | 170 x 170 | WW / CW / DL |
| SQ-RW04-R24W-* | 24W | 1560lm | 200 x 200 | White | 225 x 225 | WW / CW / DL |

Glass Trim Downlight - Input Voltage: 185-265VAC | Beam Angle 110°

| | | | | | | |
|----------------|-----|--------|-----------|-------|----------------|--------------|
| DL-RN100-6W-* | 6W | 400lm | Ø75 | White | Ø100 x 28 | WW / CW / DL |
| DL-RN160-12W-* | 12W | 800lm | Ø125 | White | Ø160 x 32 | WW / CW / DL |
| DL-RN200-18W-* | 18W | 1200lm | Ø160 | White | Ø200 x 34 | WW / CW / DL |
| DL-SQ100-6W-* | 6W | 400lm | 65 x 75 | White | 100 x 100 x 14 | WW / CW / DL |
| DL-SQ160-12W-* | 12W | 800lm | 115 x 120 | White | 160 x 160 x 14 | WW / CW / DL |
| DL-SQ200-18W-* | 18W | 1200lm | 155 x 160 | White | 220 x 220 x 14 | WW / CW / DL |

- WW - 2700K
- CW - 4200K
- DL - 6000K



RECESSED LED DOWNLIGHTS

Non-Dimmable

- WW - 2700K
- CW - 4200K
- DL - 6000K



Glass Trim Emg Downlight - Input Voltage: 230VAC | RA 80 | 1200mAh Li-ion Battery | Emergency Lumens: 75lm | Emergency 2-3hrs | Full Charge 8-10hrs

| Code | Wattage | Lumens | Cut-out Size (mm) | Material/Colour | Size (mm) | *Add Colour to Code |
|-------------------|---------|--------|-------------------|-----------------|-----------|---------------------|
| EMG-DL-RN100-7W-* | 7W | 360lm | Ø75 | White | Ø95 x 30 | WW / CW / DL |

- WW - 2700K
- CW - 4200K
- DL - 6000K



Input Voltage: 185-265VAC | Aluminium | COB LED | Aluminium Reflector

| | | | | | | |
|-----------------|-----|--------|------|-------|-----------|--------------|
| RAV160-DLC10W-* | 10W | 900lm | Ø140 | White | Ø165 x 45 | WW / CW / DL |
| RAV190-DLC20W-* | 20W | 1800lm | Ø170 | White | Ø195 x 58 | WW / CW / DL |
| RAV225-DLC30W-* | 30W | 2880lm | Ø205 | White | Ø225 x 73 | WW / CW / DL |

- WW - 2700K
- CW - 4200K



Input Voltage: 185-265VAC | Plastic

| | | | | | | |
|-------------|-----|--------|------|-------|-----------|---------|
| D6002-9W-* | 9W | 900lm | Ø93 | White | Ø108 x 52 | WW / CW |
| D9002-15W-* | 15W | 1500lm | Ø120 | White | Ø142 x 65 | WW / CW |
| D9002-20W-* | 20W | 2000lm | Ø142 | White | Ø158 x 75 | WW / CW |
| D9002-30W-* | 30W | 2700lm | Ø210 | White | Ø230 x 85 | WW / CW |
| D9002-40W-* | 40W | 3600lm | Ø210 | White | Ø230 x 85 | WW / CW |
| D9002-50W-* | 50W | 4500lm | Ø210 | White | Ø230 x 85 | WW / CW |

- WW - 2700K
- CW - 4200K
- DL - 6000K



Input Voltage: 185-265VAC | Beam Angle: 180° | Plastic

| | | | | | | |
|--------------|-----|--------|----------|-------|-----------|---------|
| PL-TD-5W-* | 5W | 350lm | Ø80-90 | White | Ø100 x 60 | CW / DL |
| PL-TD-12W-* | 12W | 840lm | Ø120-135 | White | Ø146 x 80 | CW / DL |
| PL-TD-20W-* | 20W | 1260lm | Ø155-170 | White | Ø178 x 98 | CW / DL |
| PL-TD-24W-CW | 24W | 2000lm | Ø195 | White | Ø252 x 90 | CW |

- WW - 2700K
- CW - 4200K
- DL - 6000K

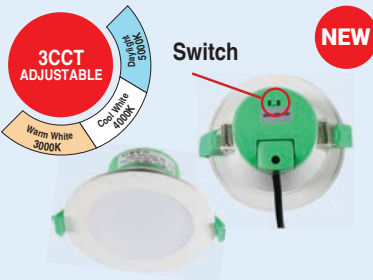

Adjustable CCT LED Light - Input Voltage: 230VAC | Switch Adjustable CCT (2700K - 4000K - 5700K) | 100° Beam Angle | IP54

| | | | | | | |
|--------------|-----|--------|------|-------|-----------|--------------|
| DL54-CCT-10W | 10W | 900lm | Ø90 | White | Ø115 x 60 | WW + CW + DL |
| DL54-CCT-16W | 16W | 1600lm | Ø110 | White | Ø140 x 65 | WW + CW + DL |
| DL54-CCT-20W | 20W | 2000lm | Ø150 | White | Ø190 x 70 | WW + CW + DL |

- WW - 2700K
- CW - 4200K



Input Voltage: 185-265VAC | Aluminium

| | | | | | | |
|----------------|-----|--------|------|--------------|-----------|---------|
| TD17-140-12W-* | 12W | 800lm | Ø125 | Satin Silver | Ø140 x 95 | WW / CW |
| TD17-165-15W-* | 15W | 1000lm | Ø145 | Satin Silver | Ø190 x 72 | WW / CW |
| TD17-195-18W-* | 18W | 1200lm | Ø175 | Satin Silver | Ø230 x 70 | WW / CW |

- WW - 2700K
- CW - 4200K
- DL - 6000K

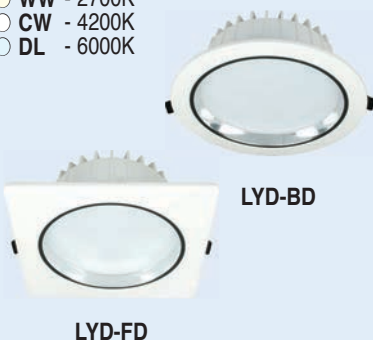

Input Voltage: 185-265VAC | Aluminium | Chrome Bezel

| | | | | | | |
|--------------|-----|-----------|------|-------|----------------|--------------|
| LYD-BD6W-* | 6W | 550lm | Ø110 | White | Ø130 x 66 | WW / CW / DL |
| LYD-BD12W-* | 12W | 1050lm | Ø145 | White | Ø162 x 70 | WW / CW / DL |
| LYD-BD18W-* | 18W | 1600lm | Ø165 | White | Ø190 x 70 | WW / CW / DL |
| LYD-BD24W-* | 24W | 2400±5%lm | Ø210 | White | Ø230 x 86 | WW / CW / DL |
| LYD-FD5W1-* | 5W | 500±5%lm | Ø80 | White | 100 x 100 x 55 | WW / CW / DL |
| LYD-FD9W1-* | 9W | 900±5%lm | Ø110 | White | 142 x 142 x 67 | WW / CW / DL |
| LYD-FD12W1-* | 12W | 1200±5%lm | Ø145 | White | 172 x 172 x 70 | WW / CW / DL |
| LYD-FD15W1-* | 15W | 1500±5%lm | Ø145 | White | 172 x 172 x 70 | WW / CW / DL |

RECESSED LED DOWNLIGHTS

Non-Dimmable

- WW - 2700K
- CW - 4200K



LBS-1201*

LBS-1202*

Input Voltage: 185-265VAC | Aluminium

| Code | Wattage | Lumens | Cut out Size (mm) | Material/ Colour | Size (mm) | *Add Colour to Code |
|------------|---------|--------|-------------------|------------------|-----------|---------------------|
| LBS-1201-* | 10W | 475lm | Ø78 | White | Ø85 x 82 | WW / CW |
| LBS-1202-* | 10W | 475lm | Ø78 | White | Ø85 x 82 | WW / CW |

- WW - 2700K
- CW - 4200K



Input Voltage: 185-265VAC | Aluminium

| | | | | | | |
|----------------|-----|--------|-----------|-------|----------------|---------|
| COB-S190/10W-* | 10W | 900lm | 90 x 90 | White | 110 x 110 x 52 | WW / CW |
| COB-S190/20W-* | 20W | 2000lm | 130 x 130 | White | 147 x 147 x 52 | WW / CW |
| COB-S190/30W-* | 30W | 3000lm | 160 x 160 | White | 180 x 180 x 52 | WW / CW |

- CW - 4200K
- DL - 6000K



15W

9W

20W

Input Voltage: 185-265VAC | Recessed LED with Reflector

| | | | | | | |
|--------------|-----|--------|------|-------|------------|---------|
| NED-D09W04-* | 9W | 680lm | Ø70 | White | Ø85 x 85 | CW / DL |
| NED-D15W04-* | 15W | 1100lm | Ø94 | White | Ø118 x 97 | CW / DL |
| NED-D20W04-* | 20W | 1500lm | Ø118 | White | Ø158 x 97 | CW / DL |
| NED-D30W04-* | 30W | 2150lm | Ø139 | White | Ø160 x 108 | CW / DL |
| NED-D40W04-* | 40W | 2800lm | Ø210 | White | Ø226 x 108 | CW / DL |
| NED-D50W04-* | 50W | 3500lm | Ø265 | White | Ø282 x 130 | CW / DL |
| NED-D60W04-* | 60W | 7200lm | Ø200 | White | Ø229 x 85 | CW / DL |
| NED-D70W04-* | 70W | 8400lm | Ø200 | White | Ø230 x 112 | CW / DL |
| NED-D80W04-* | 80W | 9000lm | Ø200 | White | Ø235 x 95 | CW / DL |

- WW - 2700K
- CW - 4200K



Complete Fitting

Input Voltage: 230VAC | IP20 | Beam Angle 38° | Optional Ring for Aesthetics

| | | | | | | |
|--------------|----|-------|-----|-------------|------------|---------|
| DL-B0105-*.* | 5W | 375lm | Ø68 | *BK, WH, SN | Ø85 x 50mm | WW / CW |
| DL-B0107-*.* | 7W | 525lm | Ø68 | *BK, WH, SN | Ø85 x 50mm | WW / CW |

* Add Trim Colours to Code: BK (Black), WH (White), SN (Satin Nickel)

Accessories

| Code | Description | *Add Colour to code |
|----------------|----------------------------|-------------------------------------------|
| DL-B010-TRIM-* | Trim Ring for surface look | BK (Black), WH (White), SN (Satin Nickel) |

- CW - 4200K



Input Voltage: 230VAC | c/w Driver | Beam Angle 30° | Glass | IP44

| | | | | | | |
|---------|----|-------|-----|-------|----------|----|
| RWCL-3W | 3W | 270lm | Ø56 | White | Ø70 x 66 | CW |
| RWCL-7W | 7W | 630lm | Ø76 | White | Ø90 x 72 | CW |

- WW - 2700K
- CW - 4200K



RW-RSL

RW-SSL

Input Voltage: 230VAC | ABS + PC | IP44

| | | | | | | |
|---------------|----|-------|--------|-------|--------------|---------|
| RW-RSL82-6W-* | 6W | 400lm | Ø65-70 | White | Ø82 x 40 | WW / CW |
| RW-SSL82-6W-* | 6W | 400lm | 65-70 | White | 82 x 82 x 40 | WW / CW |

RECESSED LED DOWNLIGHTS

Colours

| | | | | | | | | | | | | | | | | | | | | | | | | | | | | | | | | | | | | | | | | | | | | | | | | | | | | | | | | | | | | | | | | | | | | | | | | | | | | |
|--------------------------------------------------------------------------------------------------------------|-----------------------------------------------------------------------------------------------------------------------------------------------------------------------------------------------------------------------------------------------------------------------------------------------------------------------------------------------------------------------------------------------------------------------------------------------------------------------------------------------------------------------------------------------------------------------------------------------------------------------------------------------------------------------------------------------------------------------------------------------------------------------------------------------------------------------------------------------------------------------------------------------------------------------------------------------------------------------------------------------------------------------------------------------------------------------------------------------------------------------------------------------------------------------------------------------------------------------------------------------------------------------------------------------------------------------------------------------------------------------------------------------------------------------------------------------------------------------|-------------|-----------|--------|--------------|-------------------------------|----------------|--------|-------------|------|--------|----------|-------------------------------|----------------|---------|-------------|---------|--------|--------------|---------|----------------|---------|-------------|------|--------|-----------|--------------|----------------|--------|-------------|-----------|--------|-----------|----------------|----------------|---------|-------------|-----------|--------|-----------|----|----------------|---------|-------------|-----------|--------|-----------|--------------|-------------|----|-------|-----|--------|----------|-----------|-------------|----|------|-----|--------|----------|--------------|-------------|----|-------|-----|--------|----------|----------------|------------|----|-------|-----|-------|----------|---------|
| <p>○ CW - 4200K</p> <p>RW-SQ RW-RN</p> | <p>Input Voltage: 185-285VAC Blue LED Trim Dual Colour Beam Angle 110°</p> <table border="1"> <tr> <td>RW-RN145-CW-BL</td> <td>6 + 3W</td> <td>195 + 130lm</td> <td>Ø105</td> <td>White</td> <td>Ø145</td> <td>CW</td> </tr> <tr> <td>RW-RN195-CW-BL</td> <td>12 + 4W</td> <td>260 + 260lm</td> <td>Ø155</td> <td>White</td> <td>Ø195</td> <td>CW</td> </tr> <tr> <td>RW-RN245-CW-BL</td> <td>18 + 6W</td> <td>390 + 390lm</td> <td>Ø210</td> <td>White</td> <td>Ø245</td> <td>CW</td> </tr> <tr> <td>RW-SQ145-CW-BL</td> <td>6 + 3W</td> <td>195 + 130lm</td> <td>105 x 105</td> <td>White</td> <td>145 x 145</td> <td>CW</td> </tr> <tr> <td>RW-SQ195-CW-BL</td> <td>12 + 4W</td> <td>260 + 260lm</td> <td>155 x 155</td> <td>White</td> <td>195 x 195</td> <td>CW</td> </tr> <tr> <td>RW-SQ245-CW-BL</td> <td>18 + 6W</td> <td>390 + 390lm</td> <td>210 x 210</td> <td>White</td> <td>245 x 245</td> <td>CW</td> </tr> </table> | | | | | | RW-RN145-CW-BL | 6 + 3W | 195 + 130lm | Ø105 | White | Ø145 | CW | RW-RN195-CW-BL | 12 + 4W | 260 + 260lm | Ø155 | White | Ø195 | CW | RW-RN245-CW-BL | 18 + 6W | 390 + 390lm | Ø210 | White | Ø245 | CW | RW-SQ145-CW-BL | 6 + 3W | 195 + 130lm | 105 x 105 | White | 145 x 145 | CW | RW-SQ195-CW-BL | 12 + 4W | 260 + 260lm | 155 x 155 | White | 195 x 195 | CW | RW-SQ245-CW-BL | 18 + 6W | 390 + 390lm | 210 x 210 | White | 245 x 245 | CW | | | | | | | | | | | | | | | | | | | | | | | | | | | | |
| RW-RN145-CW-BL | 6 + 3W | 195 + 130lm | Ø105 | White | Ø145 | CW | | | | | | | | | | | | | | | | | | | | | | | | | | | | | | | | | | | | | | | | | | | | | | | | | | | | | | | | | | | | | | | | | | | | | | |
| RW-RN195-CW-BL | 12 + 4W | 260 + 260lm | Ø155 | White | Ø195 | CW | | | | | | | | | | | | | | | | | | | | | | | | | | | | | | | | | | | | | | | | | | | | | | | | | | | | | | | | | | | | | | | | | | | | | | |
| RW-RN245-CW-BL | 18 + 6W | 390 + 390lm | Ø210 | White | Ø245 | CW | | | | | | | | | | | | | | | | | | | | | | | | | | | | | | | | | | | | | | | | | | | | | | | | | | | | | | | | | | | | | | | | | | | | | | |
| RW-SQ145-CW-BL | 6 + 3W | 195 + 130lm | 105 x 105 | White | 145 x 145 | CW | | | | | | | | | | | | | | | | | | | | | | | | | | | | | | | | | | | | | | | | | | | | | | | | | | | | | | | | | | | | | | | | | | | | | | |
| RW-SQ195-CW-BL | 12 + 4W | 260 + 260lm | 155 x 155 | White | 195 x 195 | CW | | | | | | | | | | | | | | | | | | | | | | | | | | | | | | | | | | | | | | | | | | | | | | | | | | | | | | | | | | | | | | | | | | | | | | |
| RW-SQ245-CW-BL | 18 + 6W | 390 + 390lm | 210 x 210 | White | 245 x 245 | CW | | | | | | | | | | | | | | | | | | | | | | | | | | | | | | | | | | | | | | | | | | | | | | | | | | | | | | | | | | | | | | | | | | | | | | |
| <p>○ WW - 2700K ○ CW - 4200K</p> <p>HI-001 HI-004 HI-007 HI-010 HI-012 LED-3134*</p> | <p>Input Voltage: 230VAC Beam Angle: 20°</p> <table border="1"> <tr> <td>HI-001-1W-*</td> <td>3W</td> <td>70lm</td> <td>Ø56</td> <td>Silver</td> <td>Ø69 x 69</td> <td>WW / CW / ●R / ●G / ●B / ●Y</td> </tr> <tr> <td>HI-001-3W-*</td> <td>7W</td> <td>140lm</td> <td>Ø76</td> <td>Silver</td> <td>Ø69 x 79</td> <td></td> </tr> </table> <p>Input Voltage: 230VAC Beam Angle: 30°</p> <table border="1"> <tr> <td>HI-004-9W-*</td> <td>9W</td> <td>420lm</td> <td>Ø66</td> <td>Silver</td> <td>Ø75 x 109</td> <td>WW / CW / ●R</td> </tr> <tr> <td>HI-007-3W-*</td> <td>3W</td> <td>210lm</td> <td>Ø78</td> <td>Silver</td> <td>Ø92 x 86</td> <td>/ ●G / ●B / ●Y</td> </tr> <tr> <td>HI-007-9W-*</td> <td>9W</td> <td>420lm</td> <td>Ø78</td> <td>Silver</td> <td>Ø92 x 121</td> <td></td> </tr> <tr> <td>HI-010-1W-*</td> <td>1W</td> <td>70lm</td> <td>Ø42</td> <td>Silver</td> <td>Ø50 x 40</td> <td>WW / ●R / ●G</td> </tr> <tr> <td>HI-010-3W-*</td> <td>3W</td> <td>140lm</td> <td>Ø42</td> <td>Silver</td> <td>Ø50 x 50</td> <td>/ ●B / ●Y</td> </tr> <tr> <td>HI-012-1W-*</td> <td>1W</td> <td>70lm</td> <td>Ø42</td> <td>Silver</td> <td>Ø55 x 37</td> <td>WW / CW / ●R</td> </tr> <tr> <td>HI-012-3W-*</td> <td>3W</td> <td>140lm</td> <td>Ø42</td> <td>Silver</td> <td>Ø55 x 47</td> <td>/ ●G / ●B / ●Y</td> </tr> <tr> <td>LED-3134-*</td> <td>3W</td> <td>220lm</td> <td>Ø65</td> <td>White</td> <td>Ø79 x 27</td> <td>WW / CW</td> </tr> </table> | | | | | | HI-001-1W-* | 3W | 70lm | Ø56 | Silver | Ø69 x 69 | WW / CW / ●R / ●G / ●B / ●Y | HI-001-3W-* | 7W | 140lm | Ø76 | Silver | Ø69 x 79 | | HI-004-9W-* | 9W | 420lm | Ø66 | Silver | Ø75 x 109 | WW / CW / ●R | HI-007-3W-* | 3W | 210lm | Ø78 | Silver | Ø92 x 86 | / ●G / ●B / ●Y | HI-007-9W-* | 9W | 420lm | Ø78 | Silver | Ø92 x 121 | | HI-010-1W-* | 1W | 70lm | Ø42 | Silver | Ø50 x 40 | WW / ●R / ●G | HI-010-3W-* | 3W | 140lm | Ø42 | Silver | Ø50 x 50 | / ●B / ●Y | HI-012-1W-* | 1W | 70lm | Ø42 | Silver | Ø55 x 37 | WW / CW / ●R | HI-012-3W-* | 3W | 140lm | Ø42 | Silver | Ø55 x 47 | / ●G / ●B / ●Y | LED-3134-* | 3W | 220lm | Ø65 | White | Ø79 x 27 | WW / CW |
| HI-001-1W-* | 3W | 70lm | Ø56 | Silver | Ø69 x 69 | WW / CW / ●R / ●G / ●B / ●Y | | | | | | | | | | | | | | | | | | | | | | | | | | | | | | | | | | | | | | | | | | | | | | | | | | | | | | | | | | | | | | | | | | | | | | |
| HI-001-3W-* | 7W | 140lm | Ø76 | Silver | Ø69 x 79 | | | | | | | | | | | | | | | | | | | | | | | | | | | | | | | | | | | | | | | | | | | | | | | | | | | | | | | | | | | | | | | | | | | | | | | |
| HI-004-9W-* | 9W | 420lm | Ø66 | Silver | Ø75 x 109 | WW / CW / ●R | | | | | | | | | | | | | | | | | | | | | | | | | | | | | | | | | | | | | | | | | | | | | | | | | | | | | | | | | | | | | | | | | | | | | | |
| HI-007-3W-* | 3W | 210lm | Ø78 | Silver | Ø92 x 86 | / ●G / ●B / ●Y | | | | | | | | | | | | | | | | | | | | | | | | | | | | | | | | | | | | | | | | | | | | | | | | | | | | | | | | | | | | | | | | | | | | | | |
| HI-007-9W-* | 9W | 420lm | Ø78 | Silver | Ø92 x 121 | | | | | | | | | | | | | | | | | | | | | | | | | | | | | | | | | | | | | | | | | | | | | | | | | | | | | | | | | | | | | | | | | | | | | | | |
| HI-010-1W-* | 1W | 70lm | Ø42 | Silver | Ø50 x 40 | WW / ●R / ●G | | | | | | | | | | | | | | | | | | | | | | | | | | | | | | | | | | | | | | | | | | | | | | | | | | | | | | | | | | | | | | | | | | | | | | |
| HI-010-3W-* | 3W | 140lm | Ø42 | Silver | Ø50 x 50 | / ●B / ●Y | | | | | | | | | | | | | | | | | | | | | | | | | | | | | | | | | | | | | | | | | | | | | | | | | | | | | | | | | | | | | | | | | | | | | | |
| HI-012-1W-* | 1W | 70lm | Ø42 | Silver | Ø55 x 37 | WW / CW / ●R | | | | | | | | | | | | | | | | | | | | | | | | | | | | | | | | | | | | | | | | | | | | | | | | | | | | | | | | | | | | | | | | | | | | | | |
| HI-012-3W-* | 3W | 140lm | Ø42 | Silver | Ø55 x 47 | / ●G / ●B / ●Y | | | | | | | | | | | | | | | | | | | | | | | | | | | | | | | | | | | | | | | | | | | | | | | | | | | | | | | | | | | | | | | | | | | | | | |
| LED-3134-* | 3W | 220lm | Ø65 | White | Ø79 x 27 | WW / CW | | | | | | | | | | | | | | | | | | | | | | | | | | | | | | | | | | | | | | | | | | | | | | | | | | | | | | | | | | | | | | | | | | | | | | |
| <p>○ WW - 2700K ○ CW - 4200K</p> <p>LS0127H*</p> | <p>Input Voltage: 230VAC Beam Angle: 120°</p> <table border="1"> <tr> <td>LS0127H-*</td> <td>3W</td> <td>270lm</td> <td>Ø75</td> <td>Silver</td> <td>Ø80 x 67</td> <td>WW / CW / ●R / ●GN / ●BL / ●Y</td> </tr> </table> | | | | | | LS0127H-* | 3W | 270lm | Ø75 | Silver | Ø80 x 67 | WW / CW / ●R / ●GN / ●BL / ●Y | | | | | | | | | | | | | | | | | | | | | | | | | | | | | | | | | | | | | | | | | | | | | | | | | | | | | | | | | | | | | | | |
| LS0127H-* | 3W | 270lm | Ø75 | Silver | Ø80 x 67 | WW / CW / ●R / ●GN / ●BL / ●Y | | | | | | | | | | | | | | | | | | | | | | | | | | | | | | | | | | | | | | | | | | | | | | | | | | | | | | | | | | | | | | | | | | | | | | |
| <p>○ WW - 2700K ○ CW - 4200K</p> <p>LS0839B LS0839A</p> | <p>Input Voltage: 100-240VAC c/w LED Driver Stainless Steel</p> <table border="1"> <tr> <td>LS0839A-*</td> <td>1.5W</td> <td>120lm</td> <td>Ø60</td> <td>Silver</td> <td>Ø69 x 23</td> <td>WW / CW</td> </tr> <tr> <td>LS0839B-*</td> <td>1.5W</td> <td>120lm</td> <td>60 x 60</td> <td>Silver</td> <td>67 x 67 x 23</td> <td>WW / CW</td> </tr> </table> | | | | | | LS0839A-* | 1.5W | 120lm | Ø60 | Silver | Ø69 x 23 | WW / CW | LS0839B-* | 1.5W | 120lm | 60 x 60 | Silver | 67 x 67 x 23 | WW / CW | | | | | | | | | | | | | | | | | | | | | | | | | | | | | | | | | | | | | | | | | | | | | | | | | | | | | | | | |
| LS0839A-* | 1.5W | 120lm | Ø60 | Silver | Ø69 x 23 | WW / CW | | | | | | | | | | | | | | | | | | | | | | | | | | | | | | | | | | | | | | | | | | | | | | | | | | | | | | | | | | | | | | | | | | | | | | |
| LS0839B-* | 1.5W | 120lm | 60 x 60 | Silver | 67 x 67 x 23 | WW / CW | | | | | | | | | | | | | | | | | | | | | | | | | | | | | | | | | | | | | | | | | | | | | | | | | | | | | | | | | | | | | | | | | | | | | | |

SMART BLUETOOTH GLASS TRIM DOWNLIGHT

Smart LED Downlight - Input Voltage: 230VAC | 110° Beam Angle

| Code | Wattage | Lumens | Cut out Size (mm) | Material/ Colour | Size (mm) |
|-----------------|---------|--------|-------------------|------------------|-----------|
| BT-DL-RN100-6W | 6W | 300lm | Ø75 | White | Ø100 x 40 |
| BT-DL-RN160-12W | 12W | 840lm | Ø125 | White | Ø160 x 40 |
| BT-DL-RN200-18W | 18W | 1350lm | Ø165 | White | Ø200 x 40 |

Features

- Supports 16+ colour changes
- Synchronises lights with music rhythm

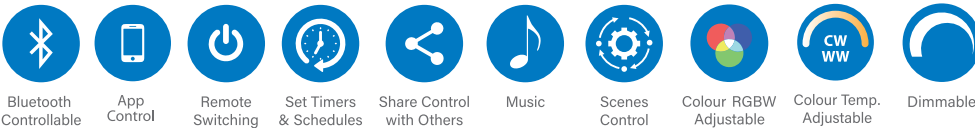

Pick Colour Set Scene Select Music

Commercial

LIGHTING

NEW

SMART BLUETOOTH FRAMELESS PANEL LIGHT

Input Voltage: 230VAC | 180° Beam Angle | CRI ≥80 | PC + Aluminium | Seamless Design

| Code | Wattage | Lumens | Cut out Size (mm) | Material/ Colour | Size (mm) |
|----------------|---------|--------|-------------------|------------------|-----------|
| MB004-9W-RGBW | 9W | 900lm | Ø71 | White | Ø90 x 27 |
| MB004-18W-RGBW | 18W | 1800lm | Ø106 | White | Ø120 x 27 |
| MB004-36W-RGBW | 36W | 3600lm | Ø206 | White | Ø225 x 27 |

Order remote Separately for RF Control (MB004-REMOTE)

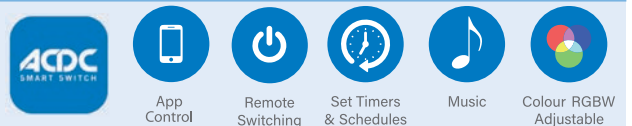

RECESSED LED DOWNLIGHTS

Non-Dimmable

Input Voltage: 230VAC | Beam Angle: 120°



| Code | Wattage | Lumens | Cut out Size (mm) | Material/ Colour | Size (mm) | *Add Colour to Code |
|-------------|---------|--------|-------------------|------------------|-----------|---------------------|
| LCM4105-RGB | 15W | 270lm | Ø75 | Silver | Ø80 x 67 | ●●●RGB |

- WW - 2700K
- CW - 4200K



Input Voltage: 185-265VAC | c/w LED Driver | Plastic | Ideal for Coastal Areas

| Code | Wattage | Lumens | Cut out Size (mm) | Material/ Colour | Size (mm) | *Add Colour to Code |
|------------|---------|--------|-------------------|------------------|-----------|---------------------|
| TD60-48D-* | 2.5W | 240lm | Ø70 | White | Ø80 x 37 | WW / CW |

RECESSED LED DOWNLIGHTS IP54-65

Non-Dimmable

- WW - 2700K
- CW - 4200K



| Code | Wattage | Lumens | Cut out Size (mm) | Material/ Colour | Size (mm) | *Add Colour to Code |
|-----------|---------|--------|-------------------|------------------|-----------|---------------------|
| CT-3312-* | 1W | 90lm | Ø50 | Silver | Ø77 x 24 | WW / CW |

Input Voltage: 12V | c/w LED Driver | Stainless Steel | IP54

| Code | Wattage | Lumens | Cut out Size (mm) | Material/ Colour | Size (mm) | *Add Colour to Code |
|-----------|---------|--------|-------------------|------------------|-----------|---------------------|
| CT-3312-* | 1W | 90lm | Ø50 | Silver | Ø77 x 24 | WW / CW |

Input Voltage: 100 - 240V | c/w LED Driver | Stainless Steel & Glass | IP54

| Code | Wattage | Lumens | Cut out Size (mm) | Material/ Colour | Size (mm) | *Add Colour to Code |
|-----------|---------|--------|-------------------|------------------|-----------|---------------------|
| CT-3620-* | 1W | 130lm | Ø75 | White | Ø105 x 40 | WW / CW |

Input Voltage: 100 - 240V | c/w LED Driver | IP65

| Code | Wattage | Lumens | Cut out Size (mm) | Material/ Colour | Size (mm) | *Add Colour to Code |
|-------------|---------|--------|-------------------|------------------|--------------|---------------------|
| LED-3322A-* | 3W | 130lm | Ø65 | Silver | Ø100 x 90 | WW / CW |
| LED-3324A-* | 3W | 130lm | Ø65 | Silver | 90 x 90 x 90 | WW / CW |

LINEAR RECESSED LED DOWNLIGHTS

Non-Dimmable

- WW - 2700K
- CW - 4200K

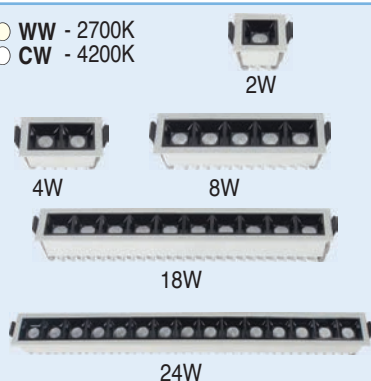

Input Voltage: 185-265VAC

| Code | Wattage | Lumens | Cut out Size (mm) | Material/ Colour | Size (mm) | *Add Colour to Code |
|---------------|---------|--------|-------------------|------------------|---------------|---------------------|
| LN-D001A-1-* | 2W | 160lm | 37 x 37 | Black | 45 x 45 x 50 | WW / CW |
| LN-D001A-2-* | 4W | 320lm | 68 x 37 | Black | 75 x 45 x 50 | WW / CW |
| LN-D001A-5-* | 8W | 640lm | 140 x 37 | Black | 145 x 45 x 50 | WW / CW |
| LN-D001A-10-* | 18W | 1440lm | 273 x 37 | Black | 280 x 45 x 50 | WW / CW |
| LN-D001A-15-* | 24W | 1420lm | 405 x 37 | Black | 411 x 45 x 50 | WW / CW |

ADJUSTABLE RECESSED MOUNT LED DOWNLIGHTS

Non-Dimmable

- WW - 2700K
- CW - 4200K



Input Voltage: 185-265VAC

| Code | Wattage | Lumens | Cut out Size (mm) | Material/ Colour | Size (mm) | *Add Colour to Code |
|-----------|---------|--------|-------------------|------------------|----------------|---------------------|
| RW-ID20-* | 20W | 1600lm | 220 x 130 | White | 230 x 146 x 86 | WW / CW |
| RW-IN25-* | 25W | 2000lm | 220 x 130 | White | 230 x 146 x 86 | WW / CW |
| RW-IN40-* | 40W | 3200lm | 220 x 130 | White | 230 x 146 x 86 | WW / CW |

ADJUSTABLE RECESSED LED DOWNLIGHTS

Non-Dimmable

- WW - 2700K
- CW - 4200K
- DL - 6000K

NEW



Input Voltage: 230VAC | 45° Beam Angle | Adjustable 360°

| Code | Wattage | Lumens | Cut out Size (mm) | Material/ Colour | Size (mm) | *Add Colour to Code |
|-----------|---------|--------|-------------------|------------------|-----------|---------------------|
| WD-GIM-7* | 7W | 696lm | Ø95 x 110 | White | Ø120 x 31 | WW/CW/DL |

- WW - 2700K
- CW - 4200K



Input Voltage: 230VAC | Beam Angle: 60° | c/w Driver

| Code | Wattage | Lumens | Cut out Size (mm) | Material/ Colour | Size (mm) | *Add Colour to Code |
|---------------|---------|--------|-------------------|------------------|-----------|---------------------|
| NED-D3W05B-* | 3W | 250lm | Ø73 | White | Ø90 x 60 | WW / CW |
| NED-D7W05B-* | 7W | 550lm | Ø98 | White | Ø105 x 85 | WW / CW |
| NED-D12W05B-* | 12W | 900lm | Ø113 | White | Ø138 x 90 | WW / CW |

- WW - 2700K
- CW - 4200K



Input Voltage: 185-265VAC | Tilttable

| Code | Wattage | Lumens | Cut out Size (mm) | Material/ Colour | Size (mm) | *Add Colour to Code |
|---------------|---------|--------|-------------------|------------------|-----------|---------------------|
| CHR-090-9W-* | 9W | 600lm | Ø75 | White | Ø95 x 66 | WW / CW |
| CHR-090-12W-* | 12W | 800lm | Ø90 | White | Ø110 x 72 | WW / CW |

- WW - 2700K
- CW - 4200K



Input Voltage: 230VAC | c/w LED Driver | Beam Angle: 30°

| Code | Wattage | Lumens | Cut out Size (mm) | Material/ Colour | Size (mm) | *Add Colour to Code |
|-------------|---------|--------|-------------------|------------------|-----------|-----------------------------|
| HI-005-3W-* | 3W | 210lm | Ø78 | Black | Ø90 x 75 | WW / CW / ●R / ●G / ●B / ●Y |
| HI-005-9W-* | 9W | 420lm | Ø78 | Black | Ø90 x 119 | |
| HI-009-3W-* | 3W | 210lm | Ø78 | Silver | Ø90 x 75 | |
| HI-009-9W-* | 9W | 420lm | Ø78 | Silver | Ø90 x 119 | |
| HI-013-1W-* | 1W | 70lm | Ø42 | Silver | Ø55 x 37 | |
| HI-013-3W-* | 3W | 140lm | Ø42 | Silver | Ø55 x 47 | |
| HI-014-3W-* | 3W | 210lm | Ø78 | Silver | Ø92 x 86 | |
| HI-014-9W-* | 9W | 420lm | Ø78 | Silver | Ø92 x 121 | |

Commercial

- WW - 2700K
- CW - 4200K



Input Voltage: 230VAC | c/w LED Driver | Beam Angle: 120°

| Code | Wattage | Lumens | Cut out Size (mm) | Material/ Colour | Size (mm) | *Add Colour to Code |
|-----------|---------|--------|-------------------|------------------|-----------|-------------------------------|
| LS0127B-* | 3W | 270lm | Ø75 | Silver | Ø90 x 46 | WW / CW / ●R / ●GN / ●BL / ●Y |

- WW - 2700K
- CW - 4200K



Input Voltage: 185-265VAC | c/w LED Driver | Plastic | Ideal for Coastal Areas

| Code | Wattage | Lumens | Cut out Size (mm) | Material/ Colour | Size (mm) | *Add Colour to Code |
|------------|---------|--------|-------------------|------------------|-----------|---------------------|
| TD70-60D-* | 3W | 285lm | Ø80 | White | Ø90 x 49 | WW / CW |

LIGHTING

- WW - 2700K
- CW - 4200K



IDEAL FOR COASTAL REGIONS

RN-AP3

SQ-AP3

Input Voltage: 185-265VAC | PBT Thermal Plastic | Tilttable | Beam Angle 38° | RA80

| Code | Wattage | Lumens | Cut out Size (mm) | Material/ Colour | Size (mm) | *Add Colour to Code |
|--------------|---------|--------|-------------------|------------------|----------------|---------------------|
| RN-AP3-3W-* | 3W | 240lm | Ø60 | White | Ø75 x 45 | WW / CW |
| RN-AP3-5W-* | 5W | 400lm | Ø75 | White | Ø90 x 45 | WW / CW |
| RN-AP3-7W-* | 7W | 560lm | Ø75 | White | Ø90 x 45 | WW / CW |
| RN-AP3-10W-* | 10W | 800lm | Ø95 | White | Ø120 x 55 | WW / CW |
| SQ-AP3-3W-* | 3W | 240lm | 60 x 60 | White | 75 x 75 x 45 | WW / CW |
| SQ-AP3-5W-* | 5W | 400lm | 75 x 75 | White | 90 x 90 x 45 | WW / CW |
| SQ-AP3-7W-* | 7W | 560lm | 75 x 75 | White | 90 x 90 x 45 | WW / CW |
| SQ-AP3-10W-* | 10W | 800lm | 95 x 95 | White | 120 x 120 x 55 | WW / CW |

ADJUSTABLE RECESSED LED DOWNLIGHTS

Non-Dimmable

- WW - 2700K
- CW - 4200K



Input Voltage: 185-265VAC | Aluminium

| Code | Wattage | Lumens | Cut out Size (mm) | Material/ Colour | Size (mm) | *Add Colour to Code |
|----------|---------|--------|-------------------|------------------|---------------|---------------------|
| VKC-50-* | 3W | 244lm | 1 x Ø80 | Silver | 90 x 90 x 49 | WW / CW |
| VKC-51-* | 6W | 450lm | 2 x Ø80 | Silver | 175 x 90 x 50 | WW / CW |
| VKC-52-* | 9W | 720lm | 3 x Ø80 | Silver | 179 x 62 x 25 | WW / CW |

- WW - 2700K
- CW - 4200K



Input Voltage: 185-265VAC | Aluminium

| Code | Wattage | Lumens | Cut out Size (mm) | Material/ Colour | Size (mm) | *Add Colour to Code |
|-----------|---------|--------|-------------------|------------------|----------------|---------------------|
| NED-D20-* | 1 x 20W | 1550lm | Ø119 | Silver | 135 x 135 x 93 | WW / CW |
| NED-D40-* | 2 x 20W | 3000lm | 238 x 119 | Silver | 260 x 135 x 93 | WW / CW |
| NED-D60-* | 3 x 20W | 4500lm | 360 x 119 | Silver | 382 x 135 x 93 | WW / CW |

- WW - 2700K
- CW - 4200K

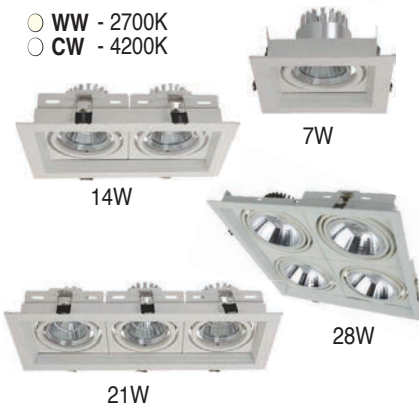

Input Voltage: 185-265VAC | Aluminium cover & Steel Housing

| Code | Wattage | Lumens | Cut out Size (mm) | Material/ Colour | Size (mm) | *Add Colour to Code |
|-------------|---------|--------|-------------------|------------------|----------------|---------------------|
| GDL6H-1R-* | 1 x 7W | 580lm | 110 x 110 | Silver | 125 x 125 x 90 | WW / CW / DL |
| GDL12H-2R-* | 2 x 7W | 1160lm | 210 x 110 | Silver | 225 x 125 x 90 | WW / CW / DL |
| GDL18H-3R-* | 3 x 7W | 1740lm | 305 x 110 | Silver | 320 x 125 x 90 | WW / CW / DL |
| GDL24HS-* | 4 x 7W | 2320lm | 215 x 215 | Silver | 230 x 230 x 90 | WW / CW / DL |

- WW - 2700K
- CW - 4200K



Input Voltage: 185-265VAC | 2 Way Adjustable

| Code | Wattage | Lumens | Cut out Size (mm) | Material/ Colour | Size (mm) | *Add Colour to Code |
|----------------|---------|--------|-------------------|------------------|----------------|---------------------|
| COB-S192/10W-* | 1 x 10W | 900lm | 93 x 97 | White | 120 x 120 x 52 | WW / CW |
| COB-S192/20W-* | 2 x 10W | 1800lm | 188 x 97 | White | 215 x 120 x 52 | WW / CW |
| COB-S192/30W-* | 3 x 10W | 2700lm | 285 x 97 | White | 310 x 120 x 52 | WW / CW |

- WW - 2700K
- CW - 4200K



Adjustable Commercial Spotlight Fittings - Input Voltage: 230VAC | Beam Angle: 24°

| Code | Wattage | Lumens | Cut out Size (mm) | Material/ Colour | Size (mm) | *Add Colour to Code |
|---------------|---------|--------|-------------------|------------------|-----------------|---------------------|
| HQ-43013-* | 12W | 1000lm | Ø155 | White | Ø162 x 120 | WW / CW |
| TLL27-15W-* | 15W | 1300lm | Ø175 | White | Ø190 x 180 | WW / CW |
| RS-Q401-20W-* | 20W | 1400lm | Ø175 | White | Ø188 x 150 | WW / CW |
| RS-Q401-30W-* | 30W | 2100lm | Ø175 | White | Ø188 x 150 | WW / CW |
| 8822-301-* | 30W | 1600lm | Ø160 | White | Ø164 x 120 | WW / CW |
| 8819-302-* | 30W | 1600lm | 160 x 160 | White | 168 x 168 x 180 | WW / CW |

DOWNLIGHTS



Aluminium Recessed Spot Lights - G4 Lamp 20W (see page 12 for LED)

| Code | *Colour | Hole Size | Bezel Size |
|-----------|-------------|-----------|------------|
| ELC-127-* | *SN, CH, WH | 25mm | 30mm |
| ELC-258-* | *SN, CH, WH | 26mm | 50mm |

Fixed - (Zinc Alloy)

| Code | *Colour | Hole Size | Bezel Size |
|----------|-----------------|-----------|------------|
| SL-200-* | *WH, CH, SN, PB | 96mm | 67mm |

*Add colour to code. Lamps excluded.



ELC-348-CH

Steel Recessed Spot Lights - 50W

| Code | *Colour | Hole Size | Bezel Size |
|------------|-------------|-----------|------------|
| ELC-348M-* | *SN, CH, WH | 75x75mm | 90x90mm |

*Add colour to code. Lamp holder excluded.



ELC-004S ELC-004C ELC-001S DT-30

Glass Recessed Spot Lights

| Code | Colour | Lamp Type | Hole Size | Bezel Size |
|----------|-----------------------|-----------|-----------|------------|
| ELC-004S | Chrome/ Clear Crystal | G4-12 | 55mm | 80mm |
| ELC-004C | Chrome/ Clear Crystal | JC-12 | 58mm | 110mm |
| ELC-001S | Chrome/ Clear Crystal | G4-12 | 55mm | 80mm |
| DT-30 | Chrome/ Clear Crystal | G4-12 | 60mm | 70mm |

For LED lamps see page 12



D-224

D-320

SL-009

SL-034A

SD105-BP

Luxury Downlighters - Lamp holder excluded.

| Code | *Colour | Hole Size | Bezel Size |
|--------|-----------------|-----------|------------|
| D-224* | *WH, PB, CH | 85mm | 100mm |
| D-320* | *WH, PB, CH, SN | 105mm | 120mm |

*Add colour to code

| Code | Colour | Hole Size | Bezel Size |
|------------|------------|-----------|------------|
| SL-009SS/G | Pearl/Gold | 89mm | 97mm |
| SL-034A | Gold | 76mm | 95mm |
| SD105-BP | Pearl/Gold | 85mm | 95mm |

Commercial

SPECIAL DOWNLIGHTS

| Lamp Holder: | G4 | MR16 | MR16 | Lamp G4 12V | |
|----------------------------|-------------------------------------|-------------|------------|------------------|-----------------------------------------------------------|
| GU5.3 or GU10 see page 148 | | | | | |
| Code Clear | D-9852B-E51 | Code | DG-110CR | DG-70/2C | SL-094SN |
| Code Blue | D-9852B-E53 | Description | CH/ Clear | CH/ Clear | Stainless Steel complete with on/off switch Lamp excluded |
| Code Rose | D-9852B-E52 | | Crystal | Crystal | JC-12-20 |
| Hole size Ø | - | Hole size Ø | 58mm | 48mm | |
| Bezel Ø | - | Bezel Ø | 110mm | 70mm | |
| Lamp Holder: | Use LED MR16 Lamp for colour effect | | | MR16 | MR16 |
| GU5.3 or GU10 see page 148 | | | | | |
| Code | SL-222G | SL-005G | SL-048G | ELC-287-T | ELC-2874-C4 |
| Colour | Satin/Clear | Satin/Clear | SN/G+Clear | CH/Clear Crystal | SN/G+Clear |
| Hole Size Ø | 67mm | 67mm | 65mm | 58mm | 68mm |
| Bezel Ø | 82mm | 81mm | 80mm | 121mm | 83mm |

*For MR16, order CLH202. For GU10, order LH2-ST.

LIGHTING

DOWNLIGHTS



Fixed (Pressed Metal) *Lamp holder excluded.**

| Code | *Colour | Hole Size | Bezel Size |
|---------|---------------------------------|-----------|------------|
| SL-076* | *WH, BK, PB, CH, RB, GB, SN, GM | 60mm | 80mm |

*Add colour to code

Fixed (Zinc Alloy die cast) *Lamp holder excluded.**

| Code | *Colour | Hole Size | Bezel Size |
|---------|-----------------|-----------|------------|
| SL-006* | *WH, PB, GM, SN | 62mm | 80mm |

*Add colour to code

2 Way Adjustable (Zinc Alloy die cast) *Lamp holder excluded.**

| Code | *Colour | Hole Size | Bezel Size |
|---------|----------------------------------------|-----------|------------|
| SL-250* | *WH, BK, PB, CH, RB, GB, SN, GM, SN/G† | 73mm | 83mm |

*Add colour to code. †Satin Nickel with gold trim

Fixed (Zinc Alloy die cast) GU10 Lamp no retaining clip required *Lamp holder excluded.**

| Code | *Colour | Hole Size | Bezel Size |
|---------|-----------------|-----------|------------|
| SL-025* | *WH, SN, CH, PB | 73mm | 82mm |

*Add colour to code

2 Way Adjustable (Zinc Alloy die cast)

| Code | *Colour | Hole Size | Bezel Size |
|---------|-----------------|-----------|------------|
| SL-028* | *WH, SN, CH, PB | 80mm | 96mm |

*Add colour to code

Eyeball Downlighters (Pressed Metal) *Lamp holder excluded.**

| Code | *Colour | Hole Size | Bezel Size |
|---------|---------------------|-----------|------------|
| SL-203* | *WH, PB, CH, GM, SN | 100mm | 110mm |
| SL-009* | *CH/G†, SN/N, SS/G | 89mm | 101mm |

*Add colour to code. †Chrome with gold trim

Fixed (pressed metal) - For MR11 *Lamp holder excluded.**

| Code | *Colour | Hole Size | Bezel Size |
|---------|------------------------|-----------|------------|
| SL-078* | *SN, PB, WH 2 way tilt | 55mm | 68mm |
| SL-080* | *SN, PB, WH fixed | 55mm | 68mm |

*Add colour to code

*For MR16, order **CLH202**. For GU10, order **LH2-ST**.

Zink Alloy Recessed Spot Lights *Lamp holder excluded.**

| Code | *Colour | Hole Size | Bezel Size |
|----------|-----------------|-----------|------------|
| ELC-144* | *SN, CH, WH, PB | 62mm | 75 x 75mm |
| ELC-429* | *SN, CH, WH, PB | 75mm | 82 x 82mm |

Aluminium Recessed Spot Lights *Lamp holder excluded.**

| Code | *Colour | Hole Size | Bezel Size |
|---------|-------------|-----------|-------------|
| SL-204* | *SN, CH, WH | 2 x 65mm | 220 x 100mm |

*Add colour to code

Aluminium Recessed Spot Lights - 50W *Lamp holder excluded.**

| Code | *Colour | Hole Size | Bezel Size |
|-----------|---------|-----------|------------|
| ELC-618B* | *WH | 95mm | 105mm |
| ELC-618C* | *WH | 95mm | 105mm |

*Add colour to code

Aluminium Recessed Spot Lights - 50W *Lamp holder excluded.**

| Code | *Colour | Hole Size | Bezel Size |
|-----------|-------------|-----------|------------|
| ELC-3390* | *SN, CH, WH | 95mm | 108mm |
| ELC-265* | *SN, CH, WH | 108mm | 127mm |

*Add colour to code

*For MR16, order **CLH202**. For GU10, order **LH2-ST**.

PLASTIC DOWNLIGHTS

Suitable for GU10 or MR16 Lamps (Lamp holder to be ordered separately, see page 148).
Ideal for Coastal Areas

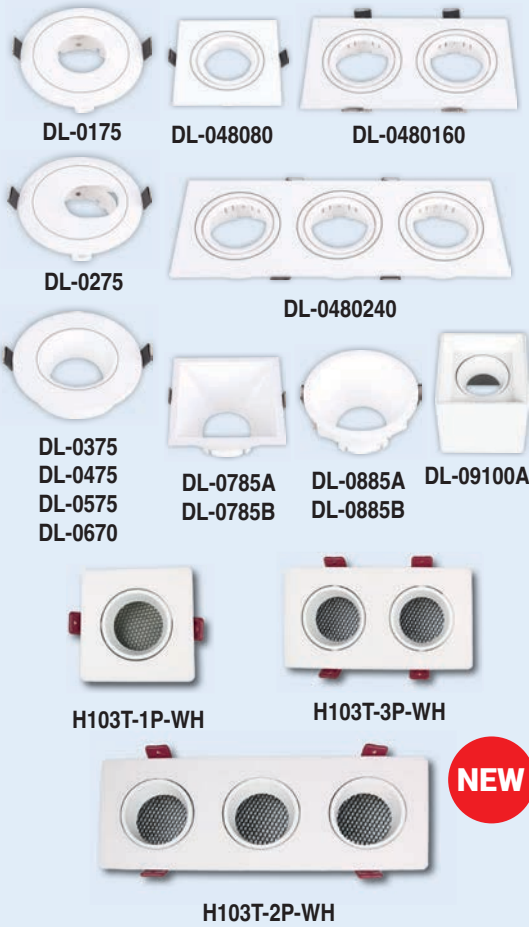

| Code | Colour | Cut-Out (mm) | Bezel Size (mm) |
|-------------------------|--------|---------------|-----------------|
| Standard Range | | | |
| DL-0175 | White | Ø75 | Ø88 |
| DL-0275 | White | Ø75 | Ø88 |
| DL-0375 | White | Ø75 | Ø90 |
| DL-0475 | White | Ø75 | Ø90 |
| DL-0575 | White | Ø75 | Ø90 |
| DL-0670 | White | Ø75 | Ø90 |
| DL-048080 | White | 75 x 75 | 93 x 93 |
| DL-0480160 | White | 80 x 160 | 173 x 93 |
| DL-0480240 | White | 80 x 240 | 252 x 93 |
| DL-0785A | White | 85 x 85 | 93 x 93 |
| DL-0785B | White | 85 x 85 | 93 x 93 |
| DL-0885A | White | Ø85 | Ø93 |
| DL-0885B | White | Ø85 | Ø93 |
| DL-09100A | White | Surface Mount | 96 x 96 x 100 |
| Anti-Glare Range | | | |
| H103T-1P-WH | White | 75 x 75 | 90 x 90 |
| H103T-2P-WH | White | 150 x 75 | 167 x 90 |
| H103T-3P-WH | White | 230 x 75 | 245 x 90 |



Waterproof Downlight Fittings IP54-IP65 - Ideal for areas with water and high humidity | Max 10W LED

| Code | Base | Size (mm) | Cut Out (mm) | Material |
|--------------|-----------|----------------|--------------|-------------------------|
| CT-3309 | MR16 | Ø86 x 35 | Ø60 | Satin Nickel |
| CT-3621 | MR16 | 100 x 100 x 85 | Ø75 | S/Steel with Glass Trim |
| KFN-020-75 | MR16/GU10 | Ø90 x 31 | Ø75 | PC/White |
| KFN-020-8080 | MR16/GU10 | 93 x 93 x 31 | Ø75 | PC/White |
| KFN-019-75 | MR16/GU10 | Ø82 x 45 | Ø75 | PC/White |

LED DOWNLIGHTS IP20

Supply Voltage: 230V/50Hz

| Code | LED-29G-A* | LED-29G-B* | LED-29G-C* | LED-29G-D* | LED-29G-F* |
|-----------------|------------|------------|------------|------------|------------|
| Hole Size (mm) | 78.5 Ø | 78.5 Ø | 78.5 Ø | 78.5 Ø | 78.5 Ø |
| Bezel Size (mm) | 88.5 Ø | 105.5 Ø | 90.5 Ø | 95 Ø | 83.5 Ø |
| LEDs | 29 | 29 | 29 | 29 | 29 |

*Add LED colour to code: ○ WH (White), ● BL (Blue), ● Y (Yellow), ● GN (Green), ● R (Red)

Supply Voltage: 230V/50Hz

| Code | LED-30T-2* | LED-25P-1* | LED-30P-1* | LED-52A-29G* | LD-29G-* |
|-----------------|------------|------------|------------|---------------|----------|
| Hole Size (mm) | 74 Ø | 60 Ø | 74 Ø | - | - |
| Bezel Size (mm) | 95 Ø | 74 Ø | 90 Ø | 64.5H x 132 Ø | 75 Ø |
| LEDs | 61 | 19 | 61 | 29 | 29 |

Spare Lamp

*Add LED colour to code: ○ WH (White), ● BL (Blue), ● Y (Yellow), ● GN (Green), ● R (Red)

CFL DOWNLIGHTS

Downlights for GX53 lamps

Material:
Plastic
Base: GX53
(Lamps
Excluded)



| Code | L0501CB* | L0503RC* | L0504RC* | L0505CL |
|-----------|------------------|---------------------------|-------------------|---------------|
| Size (mm) | Ø83 x 18H | Ø135 x 60H | Ø100 x 15H | Ø132 x 217H |
| Type | Surface mount(1) | Recessed c/w reflector(1) | Recessed fixed(1) | Ceiling mount |

*Add colour of bezel to code: ○ W (white), ● S (Silver), ● G (Gold) eg. L0504RC-W
(1)Fly lead and terminal block supplied

Downlights for GX53 lamps

Material:
Plastic
Base: GX53
(Lamps
Excluded)



With on/off switch

Downlights For PAR lamps E27

Material:
Plastic
(Lamps
Excluded)

For PAR30
& 38



Aluminium IP20



| Code | DGX5360* | EL-306-53RS* | Code | L0601CL | NB1048-PL |
|-----------|------------------------------------------------------------------------------|----------------------------------------------------|-----------|-------------|--------------------------|
| Size (mm) | Ø135 x 60H | Ø90 x 33H | Size (mm) | Ø137 x 272H | 230 x 144 x 145 |
| Type | Surface mount | Surface mount | Base | E27 | G24d |
| | *Add bezel colour: ○ W (White), ● BK (Black), ● S (Silver), ● G (Gold) | *Add bezel colour: ○ W (White), ● S (Silver) | Power | 20W CFL | 18W CFL |
| | | | Type | Fixed | Adjustable |
| | | | | White only | Cutout size: 126 x 216mm |

Supply
Voltage
230VAC

GX70 Lamp



GX70 Downlight Fittings - Satin Nickel I c/w Lamps



| Code | ESGX70-131* | CT-3712 | CT-3733 | CT-3734 |
|-------------|-------------|-----------|-----------|-----------|
| Base | GX70 | GX70 | GX70 | GX70 |
| Power | 18W | Max. 18W | Max. 18W | Max. 18W |
| Size (mm) | Ø110 x 45 | Ø148 x 52 | Ø170 x 68 | Ø120 x 40 |
| Cutout (mm) | - | 130 | 150 | 35 |

*Add colour to code: ○ WW (Warm White) 2700K, ○ CW (Cool White), 4200K

PLASTIC DOWNLIGHTS

Downlights for GU10 lamps

Material:
Flame
Retardant
ABS
Base: GU10
(Lamps
Excluded)



| Code | L0301RC* | L0302RC* | L0303RC* | DU50128* |
|-----------|-----------|------------|---------------------|--------------------------|
| Size (mm) | Ø80 x 91H | Ø85 x 67H | Ø102 x 128H | Ø128 x 70H |
| Type | Fixed | Adjustable | Fixed c/w reflector | Adjustable c/w reflector |

*Add colour of bezel to code: ○ W (White), ● S (Silver), ● G (Gold) eg. L0301RC-W. For CFL or LED Lamps only.

RECESSED AR111 DOWNLIGHTS



Low Voltage Box Lighting

| Code | Watts | Cutout Size L x W x H (mm) |
|------------|---------|----------------------------|
| HL011-1 WH | 1 x 50W | 200 x 200 x 140 |
| NB1034-E | 3 x 50W | 450 x 167 x 135 |
| NB1034-G | 4 x 50W | 320 x 320 x 135 |

- All supplied without 230/12V transformer. • Lampholder AR111.
- Colour of frame White.
- Excluding lamps see pages 23 | For LED Lamps see page 14

SURFACE MOUNT DOWNLIGHTS

Supplied complete with iron ballast. For PLC lamps only



| Code | WL-6036 | WL-8006 | WL-6046 | WL-8016 |
|-----------|-----------------|-------------|-----------------|-------------|
| Size (mm) | 197Ø x 125H | 232Ø x 220H | 197Ø x 125H | 232Ø x 220H |
| Lamp Type | PLC-13/ 2 x 13W | E27 | PLC-13/ 2 x 13W | E27 |

METAL HALIDE DOWNLIGHTS FLUSH MOUNTING



| Code | Colour | Lamp | Cut-out | Bezel |
|---------|--------------|----------------------------|---------|---------|
| NB1040 | White | Metal Halide 230V 150W max | 215mm Ø | 230mm Ø |
| T07A-SN | Satin Nickel | Metal Halide 230V 150W max | 215mm Ø | 230mm Ø |
| NB1046 | White | Metal Halide 230V 150W max | 220mm Ø | 235mm Ø |

Control gear and lamp not included. Control gear **NB150GB**. Lamps **MD-150** (see page 25-26)

| | | | | |
|----------|-------|----------------------------|-------------|-------------|
| NB1048-W | White | Metal Halide 230V 150W max | 200 x 215mm | 288 x 140mm |
|----------|-------|----------------------------|-------------|-------------|

Control gear and lamp not included. Control gear **NB150GB**. Lamps **MD-150** (see page 25-26)

METAL HALIDE DISPLAY LIGHTING



150W Metal Halide - c/w control gear

| Code | Colour | Description |
|-----------|--------|----------------------------|
| NB1044-BK | Black | Metal Halide 230V 150W max |
| NB1044-WH | White | Metal Halide 230V 150W max |
| EL200733 | White | Metal Halide 230V 150W max |

Lamp excluded, see page 25-26

LED SUSPENDED DOWNLIGHTS



Suspended Multiple Light - Supply Voltage 230VAC | c/w 12W LED Lamps

| Code | Watts | Lamp Type | Lamp Volts | Dimensions (mm) |
|----------|-------|-----------|------------|-----------------|
| NDL512E | 10W | AR111 | 12VAC | 485 x 190 x 30 |
| NDL514E | 10W | AR111 | 12VAC | 815 x 190 x 30 |
| NDL516E | 10W | AR111 | 12VAC | 1240 x 190 x 30 |
| NDL514LM | 6W | MR16 | 12VAC | 640 x 130 x 30 |
| NDL514RM | 6W | MR16 | 12VAC | 340 x 240 x 30 |
| NDL514LG | 6W | GU10 | 230VAC | 460 x 130 x 30 |
| NDL514RG | 6W | GU10 | 230VAC | 240 x 240 x 30 |

- Material: Aluminium
- Adjustable length suspension wires included (max length 1.2m)
- Fittings for low voltage AR111 and MR16 lamps electronic transformer included. For LED Lamps see page 14



HORIZONTAL CFL DOWNLIGHTS

| | | | | |
|--------------------------|--------------------------------------------------------|-----------------------|-----------------------|------------------------|
| 230VAC No Glass Cover | | | | |
| Code White | MD-76109H (1 x 9W) MD-76209H (2 x 9W) | SD-76113WH* | F609WH-18-ELC | F806WH-26-* |
| Code Satin Nickel | - | - | F609SN-18* | F806SN-26* |
| Size (mm) | 190Ø x 100H | 190Ø x 100H | 190Ø x 100H | 240Ø x 130H |
| Cut-out Size (mm) | 175Ø | 175Ø | 170Ø | 215Ø |
| Lamp Type | PL-9 | PLC-13/1 x 13W | PLC-18/2 x 18W | PLCE-26/2 x 26W |

*Add **EMG** to code for Emergency (1H)

| | | | | |
|--------------------------------------|--------------------|-----------------------|-----------------------|------------------------|
| 230VAC c/w Frosted Glass Cover | | | | |
| Code White | MD-76209HF* | MD-76213HF** | FG602WH-18* | FG806WH-26-ELC |
| Code Satin Nickel | - | - | FG602SN-18* | FG806SN-26-ELC |
| Size (mm) | 190Ø x 110H | 190Ø x 110H | 190Ø x 110H | 240Ø x 130H |
| Cut-out Size (mm) | 175Ø | 165Ø | 165Ø | 215 Ø |
| Lamp Type | PL-9/2 x 9W | PLC-13/2 x 13W | PLC-18/2 x 18W | PLCE-26/2 x 26W |

*For emergency 1H add 'EMG' to code

*For electronic ballast add '-ELC' to code. For **ELC** use **PLCE** lamps *Add **EMG** to code for Emergency (1H)
Lamps to be ordered separately see page 18

CFL DOWNLIGHTS

Vertical C.F.L. Downlights - 230V c/w Magnetic Ballast

Lamps to be ordered separately. See page 18.

| | | | |
|-------------------|-----------------------|-----------------------|----------------------------------------------|
| | | | |
| Code | SD-74113VB3 | SD-75113V | DL-2050-WH DL-2050-SN |
| Size (mm) | 150Ø x 186H | 180Ø x 190H | White Satin-Nickel |
| Cut-out Size (mm) | 125Ø | 155Ø | DL-2050-WH-26 DL-2050-SN-26 |
| Lamp Type | PLC-13/1 x 13W | PLC-13/1 x 13W | Lamp type PLC-26 (2 x 26W) |

Downlights - Ballast to be ordered separately | 270Ø x 69Hmm

Horizontal C.F.L. Downlights - (Excludes ballast. To be ordered separately)

| | | | | | | |
|--|--|-------------------|-------------------------------------|----------------------|-------------------|------------------------|
| | | Code | Colour | Cutout Size Ø | Size Ø x H | Watts/Lamp Type |
| | | ELC-8026-* | * WH (White) * SN (Satin Nickel) | 205mm | 222 x 185mm | 26W / 2 x PLC-26 |
| | | ELC-8024-* | * WH (White) * SN (Satin Nickel) | 205mm | 222 x 185mm | 26W / 2 x PLC-26 |

Lamps to be ordered separately - see page 18

Horizontal C.F.L. Downlights - (Excludes ballast. To be ordered separately)

| | | | | | | | |
|--|--|--------------|---------------|-----------------------|------------------------|--------------------------------------|------------------------|
| | | Watts | Colour | C/W Glass Code | Size Ø x H (mm) | C/W Glass and Reflector Code | Size Ø x H (mm) |
| | | 2 x 13W | White | DL-2022-WH-13 | 160 x 110 | ELC-4030-WH-13* | 140 x 95 |
| | | 2 x 13W | Satin Nickel | DL-2022-SN-13 | 160 x 110 | ELC-4030-SN-13* | 140 x 95 |
| | | 2 x 18W | White | DL-2022-WH-18 | 230 x 130 | ELC-6030-WH-18 | 180 x 120 |
| | | 2 x 18W | Satin Nickel | DL-2022-SN-18 | 230 x 130 | ELC-6030-SN-18 | 180 x 120 |
| | | 2 x 26W | Satin Nickel | - | - | ELC-7030-SN-26 | 240 x 150 |
| | | 2 x 26W | White | DL-2035-WH-26 | 230 x 230 x 115 | *This fitting uses only one 13W lamp | |
| | | 2 x 26W | Satin Nickel | DL-2035-SN-26 | 230 x 230 x 115 | | |

Lamp type for above: **PLC-13/18/26**

Lamps to be ordered separately see page 18. For Self Ballast Lamps see page 23.

For Ballast see page 157-159

ELC range

COMMERCIAL LED SPOTLIGHTS CEILING MOUNT

| | Surface Mount | | | Recessed |
|-----------------------------------------------------------------------------------|---------------------|----------------------|----------------------|----------------------|
| Supply Voltage: 230VAC Tilttable: 90° Rotatable: 355° Beam Angle: 36° | | | | |
| Code | LWQ-001-7W-* | LWQ-001-10W-* | LWQ-001-12W-* | LWQ-003-12W-* |
| Wattage | 7W | 10W | 12W | 12W |
| Lumens | 560lm | 800lm | 960lm | 960lm |
| Size (mm) | Ø100 x 61 | Ø100 x 115 | Ø100 x 185 | Ø100 x 60 |
| Cutout (mm) | - | - | - | Ø95 |

* Add Colour to Code: **W** (White), **B** (Black). * Add Colour Temp to Code: ○ **WW** (Warm White) 2700K, ○ **CW** (Cool White) 4200K, ○ **DL** (Daylight) 6000K

| Supply Voltage: 230VAC | Adjustable Focus | | Fixed Focus | | | | |
|---------------------------|------------------|------------------|------------------|----------------------|----------------------|----------------------|----------------------|
| | | | | <td> </td> | | | |
| Code | 8302-* | A020-01-* | A001-01-* | MS-WL003003-* | MS-WL003006-* | MS-WL004006-* | MS-WL004012-* |
| Wattage | 9W | 9W | 13W | 3 x 1W (3W) | 6 x 1W (6W) | 6 x 1W (6W) | 12 x 1W (12W) |
| Beam Angle | Focus 22°-62° | Focus 18°-55° | Fixed 35° | 30° | 30° | 30° | 30° |
| Lumen | 850lm | 850lm | 1045lm | 180lm | 2 x 180lm | 360lm | 2 x 360lm |
| Colour | Black | Silver | Silver | Silver | Silver | Silver | Silver |
| Size | Ø80 x 90 | 190 x 80 x 100 | Ø90 x 180 | 105 x 55 x 12 | 178 x 55 x 121 | 123 x 63 x 130 | 213 x 63 x 130 |

*Add colour to code: ○ **WW** (Warm White) 3000K, ○ **CW** (Cool White) 4000K *Add colour to code: ○ **WW** (Warm White) 3000K, ○ **CW** (Cool White) 4000K
○ **DL** (Daylight) 6000K

LED SPOTS/ DISPLAY LIGHTS

| | | |
|--------------------------------------------|-----------------------------------------------------------------------------------------------------|------------------------------------------------------------------------------------------|
| Supply Voltage: 100-240VAC Angle 60° | <td> <p>*Add colour to code: ○ WW (Warm White) 2700K, ○ DL (Daylight) 6000K</p> </td> | <p>*Add colour to code: ○ WW (Warm White) 2700K, ○ DL (Daylight) 6000K</p> |
|--------------------------------------------|-----------------------------------------------------------------------------------------------------|------------------------------------------------------------------------------------------|

DISPLAY / POP-UP STAND LIGHTS

| | | | | | |
|---------------------|----------------------------|----------------|-------------------|-----------------|-----------------|
| Lamps not included. | Supplied with two in a box | Chrome Plated | | | |
| Code | E2-DL-006 | CT-3521 | EL202702-B | EL202702 | EL202723 |
| Supply Volts | 230VAC | 12VDC | 230VAC | 12VAC/DC | 230VAC |
| Power | 150W | 50W Max. | 1 x 3W | 1 x 3W | 3 x 1W |
| Lamp Holder | Rx7s (78mm) | MR16 | LED | LED | LED |
| Size (mm) | 590 | 55 x 50 | 70 x 140 | 70 x 170 | 77 x 425 |

NEW

MAGNETIC LED TRACK LIGHTS

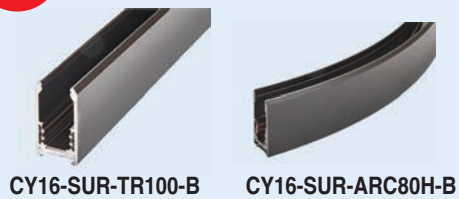

CY16-SUR-TR100-B

CY16-SUR-ARC80H-B

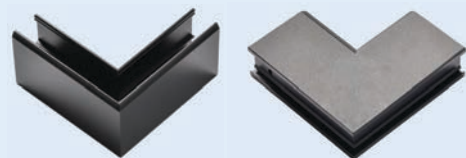

CY16-SUR-HOR-B

CY16-SUR-VER-B



CY16-FJ02-B

CY16-FJ03-B

CY16-FJ04-B



CY16-TR-CON-B

CY16-ARC-CON-B



CY16-30CON

CY16-ARC-200CON

CY16-BI-DR200

Surface Mount Track

| Code | Type | Dimensions |
|--------------------|------------------|----------------|
| CY16-SUR-TR100-B | Straight | 1000mm |
| CY16-SUR-TR200-B | Straight | 2000mm |
| CY16-SUR-TR300-B | Straight | 3000mm |
| CY16-SUR-ARC80Q-B | Quarter Curve | 1/4 of Ø800mm |
| CY16-SUR-ARC100Q-B | Quarter Curve | 1/4 of Ø1000mm |
| CY16-SUR-ARC120Q-B | Quarter Curve | 1/4 of Ø1200mm |
| CY16-SUR-ARC80H-B | Half Curve | 1/2 of Ø800mm |
| CY16-SUR-ARC100H-B | Half Curve | 1/2 of Ø1000mm |
| CY16-SUR-ARC120H-B | Half Curve | 1/2 of Ø1200mm |
| CY16-SUR-HOR-B | Horizontal Track | 40 x 40mm |
| CY16-SUR-VER-B | Vertical Track | 100 x 100mm |

Track Adaptors

| | | |
|----------------|---------------------|------------------|
| CY16-FJ02-B | 2 Directions (15°) | 120 x 50mm |
| CY16-FJ03-B | 3 Directions (15°) | 120 x 80 x 50mm |
| CY16-FJ04-B | 4 Directions (15°) | 120 x 120 x 50mm |
| CY16-TR-CON-B | Rigid Straight | 144 x 17 x 19mm |
| CY16-ARC-CON-B | Arc Track Connector | 50.5 x 16 x 17mm |

Track Power Adaptors

| | | |
|-----------------|-----------------------------------|---------------------|
| CY16-30CON | Straight Track 4 Wire (LN+Signal) | 104 x 17 x 19mm |
| CY16-ARC-200CON | Curve Track 4 Wire (LN+Signal) | 50.5 x 16 x 17mm |
| CY16-BI-DR100 | DC48V, 80W, AC176-264V | 280 x 22.2 x 49.5mm |
| CY16-BI-DR200 | DC48V, 150W, AC176-264V | 280 x 22.2 x 49.5mm |

Track Luminaires IP20 - Straight Matt Black | CRI 90 | Die-cast Aluminium



CY16-L300-B

CY16-LR12-B

CY16-AR12-B



CY16-S11-B

CY16-ARC-S02-B

| Code | Wattage | Lumens | Beam Angle | Dimensions |
|------------------|---------|--------|------------|------------------|
| CY16-L300-B-* | 7W | 420lm | 120° | 302 x 17 x 42mm |
| CY16-LR12-B-* | 12W | 840lm | 36° | 255 x 17 x 42mm |
| CY16-AR12-B-* | 12W | 840lm | 36° | 254 x 17 x 102mm |
| CY16-S11-B-* | 11W | 800lm | 36° | Ø50 x 86mm |
| CY16-ARC-S02-B-* | 2W | 100lm | 36° | 50 x 17 x 55mm |
| CY16-ARC-11-B-* | 11W | 800lm | 36° | Ø50 x 145mm |

*Add colour to code: ○ WW (Warm White) 3200K, ○ CW (Cool White) 4200K, ○ DL (Daylight) 6000K

FLEXIBLE TRACK LIGHT SYSTEM



Flexible Track Light Kit - Input Voltage: 230VAC

| Code | Description |
|---------------|-----------------------------------|
| LT-FT5094-4PA | 2m Flexible Track Light Kit with |
| | - 1 x Floating Canopy |
| | - 4 x Rail Supports |
| | - 4 x GU10 Track Heads |
| | - Middle Connector to join tracks |

2 WIRE LED TRACK LIGHTS

- WW - 2700K
- CW - 4200K



Standard LED Track Head - Input Voltage: 230VAC | CRI > 80

| Code | Wattage | Beam Angle | Lumens | Size (mm) | * Add Colour Temp to Code |
|---------------|---------|------------|-----------|-----------------|---------------------------|
| TLL19-9W-*.* | 9W | Fixed 24° | 850lm | Ø60 x 90 | WW / CW |
| TLL19-12W-*.* | 12W | Fixed 30° | 1100lm | Ø90 x 120 | WW / CW |
| 8611-311-*.* | 30W | Fixed 24° | 1600lm | Ø80 x 140 | WW / CW |
| GDD-002-*.* | 7W | 36° | 490lm | Ø47 x 150 | WW / CW |
| 371-X2G-*.* | 7W x 2 | 15° | 700lm x 2 | 120 x 125 x 142 | WW / CW |
| GD15A-40-*.* | 40W | 15° | 3200lm | 140 x 100 x 230 | WW / CW |
| GD01-H07C-*.* | 7W | 24° | 560lm | 100 x 55 x 110 | WW / CW |

*Add colour to code: ○ WH (White), ● BK (Black)

*Add colour to code: ○ W (White), ● B (Black)

- WW - 2700K
- CW - 4200K



Commercial LED Track Head - Input Voltage: 220-240VAC | CRI > 80

| Code | Wattage | Beam Angle | Lumens | Size (mm) | * Add Colour Temp to Code |
|-----------------|---------|------------|-------------|----------------|---------------------------|
| XH-TL-15W-F-*.* | 15W | 24° | 1400lm | 60 x 77 x 229 | WW / CW |
| XH-TL-25W-F-*.* | 25W | 24° | 2100lm | 71 x 88 x 249 | WW / CW |
| XH-TL-35W-F-*.* | 35W | 24° | 3040lm | 83 x 100 x 252 | WW / CW |
| XH-TL-10W-B-*.* | 10W | 40° | 830lm | 114 x 172 x 75 | WW / CW |
| XH-TL-20W-B-*.* | 20W | 40° | 1680lm | 132 x 177 x 75 | WW / CW |
| XH-TL-30W-B-*.* | 30W | 40° | 2600lm | 144 x 180 x 75 | WW / CW |
| XH-TL-15W-E-*.* | 15W | 15° - 50° | 1200-1400lm | Ø62 x 150 | WW / CW |
| XH-TL-25W-E-*.* | 25W | 15° - 50° | 1900-2100lm | Ø90 x 197 | WW / CW |
| XH-TL-35W-E-*.* | 35W | 15° - 50° | 3040-3550lm | Ø90 x 197 | WW / CW |
| XH-TL-45W-E-*.* | 45W | 60° | 4100lm | 226 x 248 x 40 | WW / CW |

*Add colour to code: ○ W (White), ● B (Black)

- WW - 2700K
- CW - 4200K

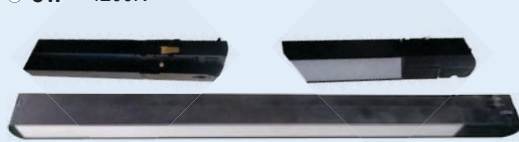

Linear LED Track Head - Input Voltage: 230VAC | CRI > 80

| Code | Wattage | Beam Angle | Lumens | Size (mm) | * Add Colour Temp to Code |
|---------------|---------|------------|--------|-----------|---------------------------|
| LX-LT-10W-*.* | 10W | 110° | 1300lm | 300 | WW / CW |
| LX-LT-20W-*.* | 20W | 110° | 2600lm | 600 | WW / CW |
| LX-LT-30W-*.* | 30W | 110° | 3900lm | 1000 | WW / CW |



Adjustable LED Track Head - Input Voltage: 230VAC | Tilttable: 90° | Rotatable: 355°

| Code | Wattage | Beam Angle | Lumens | Size (mm) | * Add Colour Temp to Code |
|-----------------|---------|------------|--------|------------|---------------------------|
| LWQ-002-7W-*.* | 7W | 36° | 490lm | Ø100 x 61 | WW / CW |
| LWQ-002-10W-*.* | 10W | 36° | 800lm | Ø100 x 115 | WW / CW |
| LWQ-002-12W-*.* | 12W | 36° | 900lm | Ø100 x 185 | WW / CW |

*Add colour to code: ○ W (White), ● B (Black)

| | | | | | |
|-------------|----|-----|-------|-----------|---------|
| LWQ-068-*.* | 7W | 36° | 560lm | Ø40 x 260 | WW / CW |
|-------------|----|-----|-------|-----------|---------|

*Add colour to code: ○ W (White), ● B (Black)

- WW - 2700K
- CW - 4200K

3CCT Adjustable Track Light Head - Input Voltage: 230VAC | CRI 90 | Dimmable 10-100% | 36° Beam Angle | Colour Temperature Adjustable: 3000K-4000K-5000K Switchable

| Code | Wattage | Beam Angle | Lumens | Size (mm) | Colour Temp. Adj. |
|--------------|---------|------------|--------|-----------|-------------------|
| CCT-TL-20W-* | 20W | 36° | 2000lm | Ø76 x 139 | WW + CW + DL |

*Add colour to code: ○ W (White), ● B (Black)

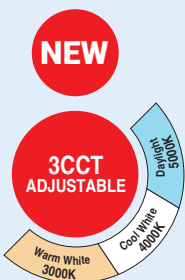

TRACK LIGHT & ACCESSORIES

| Track Lighting - Track supplied with End Cap and Power End Cap | | | | | Spare End Cap & Power End Cap | |
|----------------------------------------------------------------------------------------|------------|------------|------------|----------|------------------------------------------------|----------|
| | | | | | | |
| Code 2 Wire | YD-2C-*.** | | | | YD-E-2-* | KTK-V |
| Code 3 Wire | | YD-3C-*.** | | | YD-E-3-* | YD-F-3-* |
| Code 4 Wire | | | YD-4C-*.** | | YD-E-4-* | YD-F-4-* |
| *Add to code: length (meter) 1, 2 or 3. **Add colour to code: ○ W (White), ● B (Black) | | | | | | |
| Track Lighting - Track supplied with End Cap and Power End Cap | | | | | Spare End Cap & Power End Cap | |
| | | | | | | |
| Code 2 Wire | KTK-I | KTK-L | KTK-T | KTK-X | YD-E-2-* | KTK-V |
| Code 3 Wire | YD-I-3-* | YD-L-3-* | YD-T-3-* | YD-X-3-* | YD-E-3-* | YD-F-3-* |
| Code 4 Wire | YD-I-4-* | YD-L-4-* | YD-T-4-* | YD-X-4-* | YD-E-4-* | YD-F-4-* |
| *Add colour to code: ○ W (White), ● B (Black). | | | | | *Add colour to code: ○ W (White), ● B (Black). | |

Track Light Fitting & Pendant Adaptors - Universal Adaptors to modify existing tracks to heads | Pendant track adaptors allow pendants to wire to adaptor

| | | | | | | | |
|-----------------------------------------------|-------|-------|-------|-------|-------|-------|-------|
| | | | | | | | |
| Code 2 Wire | 201-* | 202-* | 203-* | | | | |
| Code 3 Wire | | | | 301-* | 302-* | | |
| Code 4 Wire | | | | | | 401-* | 402-* |
| *Add colour to code: ○ W (White), ● B (Black) | | | | | | | |

MINI LED TRACK & DISPLAY CABINET LIGHTS

| Track - Can be cut to length | | Connectors | | | | Fixing Clip | |
|-----------------------------------------------------------------------|--------------------|-------------------------|-----------|---------------------------------------------------|---------------|---------------|--|
| | | | | | | | |
| Code | TT-1000 | TT-23 | TT-24 | TT-25 | TT-27 | TT-37M | |
| Size (mm) | 1000 x 11.8 x 9.6H | 50 | 31 x 31H | 50 x 31 x 31H | 31 x 31 x 31H | 12 x 12 x 15H | |
| Description | Track 1m | Straight | L Corner | T Connector | 3D Connector | Clip | |
| Live / Dead Ends | | End Caps | | | | Fixing Clip | |
| | | | | | | | |
| Code | TT-38C | TT-38D | TT-38 | TT-DE1 | TT-ECL | TT-ECR | |
| Description | Corner Live | Corner Dead End | Live End | Dead End | End Cap Left | End Cap Right | |
| Heads - Adjustable, Beam Angle 15° | | Strips - Beam Angle 15° | | LED Cabinet Lights - Supply Voltage: 110 - 240VAC | | | |
| | | | | | | | |
| Code | TT-32-* | TT-31-* | TT-S250-* | TT-S500-* | LUA2411-1 | LUA2411-3 | |
| Wattage | 1W | 1W | 9W | 9W | 1W | 3W | |
| Lumens | 100lm | 100lm | 900lm | 900lm | 90lm | 250lm | |
| Size (mm) | Ø31 x 63 | Ø18 x 60 | 250 x 12H | 500 x 12H | 75 x 19 x 250 | 68 x 20 x 250 | |
| *Add colour to code: ○ WW (Warm White) 3000K, ○ CW (Cool White) 4000K | | | | | | | |

NEW LED DOWNLIGHT / CABINET LIGHTS

Supply Voltage:
230VAC



| Code | LCS0210R-1-* | LCS0210S-1-* | LCS0310R-1-* | LCS0320R-3-* | LCS0420R-3-* |
|-------------------|--------------|--------------|--------------|--------------|--------------|
| Power | 1W | 1W | 1W | 3W | 3W |
| Lumen | 85lm | 85lm | 85lm | 255lm | 255lm |
| Size (mm) | Ø30 x 22 | 30 x 30 x 22 | Ø35 x 25 | Ø40 x 25 | Ø40 x 25 |
| Cut Out Size (mm) | Ø27 | 27 x 27 | Ø25 | Ø30 | Ø35 |

Supply Voltage:
230VAC



| Code | LCS0420S-3-* | LCS0420Q-3-* | LCS0420H-3-* | LCS0420A-3-* | LCS0820R-3-* |
|-------------------|--------------|--------------|--------------|--------------|--------------|
| Power | 3W | 3W | 3W | 3W | 3W |
| Lumen | 255lm | 255lm | 255lm | 255lm | 255lm |
| Size (mm) | 40 x 40 x 25 | Ø40 x 25 | 44 x 44 x 30 | Ø44 x 30 | Ø55 x 42 |
| Cut Out Size (mm) | 35 x 35 | Ø35 | 35 x 35 | Ø35 | Ø43 |



| Code | LCS0820S-3-* | LCS1425R-3-* | LCS1425R-5-* | LCS1425S-3-* | LCS1425S-5-* |
|-------------------|--------------|--------------|--------------|--------------|--------------|
| Power | 3W | 3W | 5W | 3W | 5W |
| Lumen | 255lm | 255lm | 425lm | 255lm | 425lm |
| Size (mm) | 55 x 55 x 42 | Ø50 x 55 | Ø50 x 62 | 50 x 50 x 55 | 50 x 50 x 62 |
| Cut Out Size (mm) | 43 x 43 | Ø42 | Ø42 | 42 x 42 | 42 x 42 |

*Add colour to code: ○ WW (Warm White) 3000K, ○ CW (Cool White) 4200K

Commercial

Supply Voltage:
230V/50Hz.
Constant current
driver to be ordered
separately
CLD-B3503 (pg 888)



| Code | QL201B20-* | QL101B11-* | LWQ-009-* | QL102B02-* | QL103B32-* |
|-------------------|------------|------------|-----------|------------|------------|
| Power | 1W | 1W | 12W | 1W | 1W |
| Lumen | 83lm | 83lm | 240lm | 83lm | 83lm |
| Size (mm) | Ø52 | Ø52 | Ø41 x 89 | Ø41.5 | Ø41.5 |
| Cut Out Size (mm) | Ø42 | Ø42 | Ø35 | Ø35 | Ø35 |

*Add LED colour to code: ○ WW (Warm White) 2700K, ○ CW (Cool White) 4200K, ● BL (Blue), ● Y (Yellow), ● GN (Green), ● R (Red)

LIGHTING

Mini Aluminium LED Downlights

Supply Voltage:
230V/50Hz.
Constant current
driver to be ordered
separately
CLD-B3503 (pg 888)

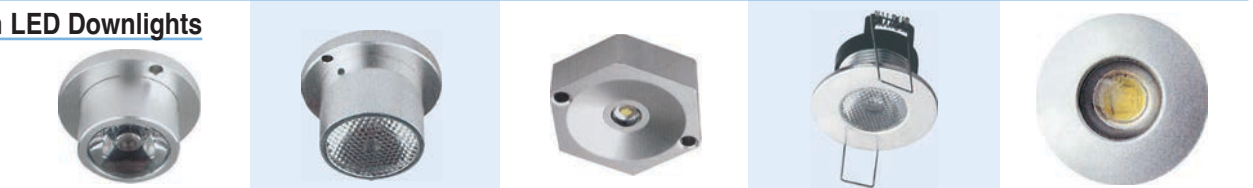

| Code | EL212003-* | EL212004-* | EL212005-* | EL202732-B-* | EL212007-* |
|-------------------|--------------|--------------|------------|--------------|------------|
| LED | 1W (350mA) | 1W (350mA) | 1W (350mA) | 1W (700mA) | 1W (350mA) |
| Req PSU | CLD-B3503 | CLD-B3503 | CLD-B3503 | LED-N12-9W | CLD-B3503 |
| Size (mm) | Ø23.5 x 16.5 | Ø23.5 x 16.5 | Ø30 x 9 | Ø49 | Ø30 |
| Cut-out Size (mm) | - | - | - | Ø40 | Ø24 |

*Add LED colour to code: ○ W (Cool White) 4200K, ● BL (Blue), ● Y (Yellow), ● GN (Green), ● R (Red)

LED CABINET LIGHTS

| | | | | |
|-------------------------|----------------------------------------------------------------------------|-------------------|-----------------------------------------------------------------------------|------------------------------------------------|
| | 12VDC | 12VDC | | Supply Voltage: 230V/50Hz c/w LED Driver |
| | | | | |
| Code | EL202744-* | EL200867-* | LS0841-1-* | LED-3199-* |
| LED | 1.2W | 0.5W | 3W | 3W |
| Req PSU | 12V | 12V | Included | Included |
| Size (mm) | Ø60 x 9 | Ø40 | Ø57 x 7.5 | Ø44 x 45 |
| Cut-out Size (mm) | - | Ø34 | - | - |
| *Add LED colour to code | ○ W (Cool White) 4200K, ● BL (Blue), ● Y (Yellow), ● GN (Green), ● R (Red) | | ○ CW (Cool White) 4200K, ● BL (Blue), ● Y (Yellow), ● GN (Green), ● R (Red) | |

| | | | |
|-----------------------------------------------------------------------------|------------------|-----------------|----------------------|
| Supply Voltage: 100-240VAC c/w LED Driver, Transformer & Switch | | | |
| Code | LS0834-WW | LS0833-* | LS0839A-KIT-* |
| Wattage | 3W x 4 | 1.28W | 28.5W x 3 |
| Lumens | 40lm x 4 | 30lm | 120lm x 3 |
| Size | Ø75 x 4H | Ø75 x 19H | Ø69 x 23H |
| IP Rating | IP20 | IP20 | IP20 |

| | | | |
|-------------------------------------|--------------------|-------------------------|-------------------------|
| | | | |
| Code | LS0841-3-* | LS-CG2301YM-3-PW | LS-CG2301FM-3-PW |
| Wattage | 3W x 3 | 1.5W x 3 | 1.5W x 3 |
| Lumens | 148lm x 3 | 80lm | 80lm |
| Size | Ø57 x 7.5H | Ø65 x 15 | 75 x 75 x 20 |
| IP Rating | IP20 | IP20 | IP20 |
| IP20 - Linkable 80-260VAC | | | |
| Code | QL-6022A-* | QL-6023A-* | QL-6025A-* |
| Size (mm) | 239L x 51.5W x 29H | 360L x 51.5W x 29H | 605L x 51.5W x 29H |
| Lumen | 120lm | 180lm | 300lm |
| Watts | 2 x 1W | 3 x 1W | 5 x 1W |

*Add colour to code: ○ WW (Warm White) 2700K, ○ CW (Cool White) 4200K

LED HINGE LIGHT

| | | | | | |
|-------------------|-----------------|------------------|-------------------|-------------------|--------------------------------|
| | | | Code | CHL-A49A/2 | CH-A04/2 |
| CHL-A49A/2 | CH-A04/2 | Installed | Lumens | 16lm | Soft Close Hinge (Set of 2) |
| | | | Integrated | On / Off | |
| | | | Sensor | Trigger | |
| | | | Operating Voltage | 12V | |
| | | | Application | Cupboards | |
| | | | Spare Battery | AC531 | |

CABINET LIGHTS

230VAC

Power Supply

Portable Makeup Light IP40 - Input Voltage: 5VDC USB
 | 3 Level Touch Dimming | RA > 80 | Colour Temperature:
 6000K | Mounting Suction Cup Included

| Code | Wattage | Lumens | Size (mm) |
|---------|---------|--------|-----------|
| PI4A1CH | 4W | 180lm | Ø14 x 206 |

Complete with Power Supply 230VAC / 5VDC

230VAC

- CW - 4200K
- DL - 6500K



Power Supply

Smart Sensor Light - Auto On & Off IP20 - Input
 Voltage: 5VDC | PIR & Daylight Sensor | Sensing Distance
 > 3m | Adjustable Time Delay | Colour Temperature: 6000K |
 Magnetic Mounting Strip Included

| Code | Wattage | Lumens | Size (mm) |
|------------|---------|--------|---------------|
| M3062CH-DL | 4W | 180lm | 315 x 60 x 30 |

Complete with Power Supply 230VAC / 5VDC

230VAC

- CW - 4200K
- DL - 6500K



Power Supply

Smart PIR Cabinet Light IP20 - Input Voltage 100 -
 240VAC | PIR Sensor | Sensing Distance < 3m | 2 Minute
 Delay Off | Colour Temperature: 6000K | Mounting Kit Included

| Code | Wattage | Lumens | Size (mm) |
|------------|---------|--------|---------------|
| M45A1CH-DL | 11W | 850lm | 450 x 39 x 10 |

Complete with Power Supply 230VAC / 5VDC

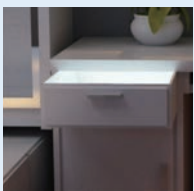
5VDC USB



Charger

Mini Drawer LED Light - Rechargeable 330mAh Lithium
 Battery | Input Voltage: 5V (USB) | Colour Temperature: 6000K
 | Auto On/Off | Very Small, Portable & Easy to Install | Magnetic
 Mounting Kit Included

| Code | Wattage | Lumens | Size (mm) |
|---------|---------|--------|--------------|
| MMSL1/2 | 0.6W | 36lm | 68 x 28 x 11 |

Complete with USB Cable

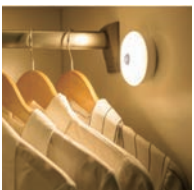
Commercial

5VDC USB



Charger

Rechargeable PIR Cabinet Light IP20 - Beam Angle 120°
 | Battery Capacity 1200mAh | PIR Sensor | Switch Mode: Left -
 off, Right - manual mode, Middle - PIR | 12 Second Delay Off |
 Colour Temperature: 6000K | Mounting Kit Included

| Code | Wattage | Lumens | Size (mm) |
|---------|---------|--------|------------|
| M80P2CH | 2W | 150lm | Ø80 x 28.5 |

Complete with USB Cable

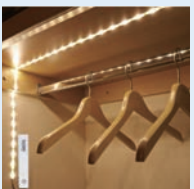
LIGHTING

Battery Operated

Battery Operated PIR Wardrobe Light IP20 - 4 x AAA
 Battery (Not Included) | PIR Sensor | Sensing Distance 2m |
 Switch Mode: Upwards - PIR, Downwards - Manual Mode |
 12 Second Delay Off | Colour Temperature: 4000K | Mounting
 Tape Included

| Code | Wattage | Lumens | Strip Size (mm) |
|---------|---------|--------|-----------------|
| M21M1CH | 2.4W | 200lm | 1000 x 8 x 2.3 |

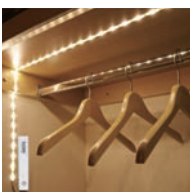
Battery Operated
NEW

LED Rechargeable PIR Wardrobe Light IP20 -
 1m Length LED Strip | Controller size: 112 x 35 x 26.5mm |
 Li-Battery, 1500MAh | PIR Sensor | Sensing Distance:
 2.5m | Function: Motion Sensor or Switch | Charging Time:
 2-3hrs | >3hrs Working Time | Colour Temperature: 4000K |
 Accessories: 1m USB Charge Cable

| Code | Wattage | Lumens | Strip Size (mm) |
|-----------|---------|--------|-----------------|
| M21M1CH-R | 2.4W | 200lm | 1000 x 8 x 2.3 |

BATTERY OPERATED CABINET LIGHTS

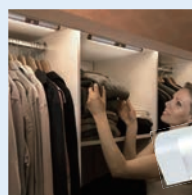

5VDC USB



Charger

Rechargeable PIR Wardrobe Light - Battery Capacity 900mAh | PIR Sensor | Sensing Distance 2m | Switch Mode: Left - PIR, Right - Manual, Middle - Off | Colour Temperature: 4000K | **IP20** | Magnetic Mounting Kit Included

| Code | Wattage | Lumens | Size (mm) |
|---------|---------|--------|----------------|
| M33A1GB | 1.5W | 120lm | 330 x 345 x 15 |

Complete with USB Cable



5VDC USB

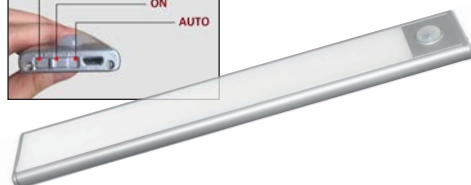

Ultra Slim Cabinet Light - 5V USB Charging | Alluminium Alloy | **IP20** | c/w Built-in Magnet for Easy Mounting, Mounting Clips & USB Charging Cable | Colour Temp: 4200K | c/w Motion Sensor

| Code | Wattage | Lumens | Battery | Size (mm) |
|------------|---------|--------|---------|--------------|
| DL-6110-23 | 1.4W | 140lm | 900mAh | 230 x 40 x 9 |
| DL-6110-40 | 3W | 300lm | 1500mAh | 400 x 40 x 9 |
| DL-6110-60 | 3.2W | 320lm | 2000mAh | 600 x 40 x 9 |

NEW

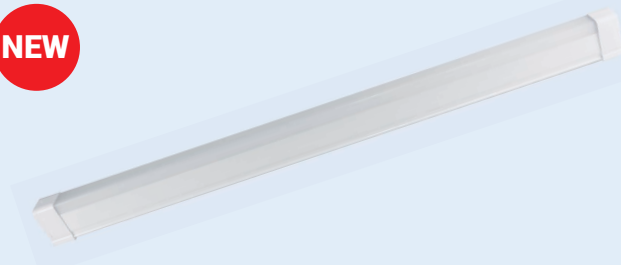

LED Linear T5 Rechargeable Lamp **IP20** - 5VDC USB Charging | Battery Capacity: 4W - 1x1.8Ah, 6W - 2x1.8Ah | Charging Time: 4W - 2hrs, 6W - 4hrs | Working Time: 4W - 1hr Full Power & 2hrs Half Power, 6W - 2hrs Full Power & 4hrs Half Power | 3 Working Modes: Full Power, Half Power, Flashing | Colour Temp: 8000K | Beam Angle: 120° | Magnetic Mounting Kit included

| Code | Wattage | Lumens | Size (mm) |
|---------------|---------|--------|---------------|
| JCL-T5-901-4W | 4W | 400lm | 320 x 40 x 23 |
| JCL-T5-901-6W | 6W | 600lm | 540 x 40 x 23 |

BATTERY OPERATED CABINET LIGHTS



Cupboard & Wardrobe Light - Battery Operated Linear Light | Integrated 6 SMD LED's | 4000K | Integrated On/Auto/Off Switch | Magnet Operated | 6 x AA Batteries (Not Included) | c/w Mounting Bracket and Screws.

| Code | Wattage | Lumens | Size (mm) |
|---------|---------|--------|---------------|
| BOCL02W | 2W | 130lm | 400 x 43 x 27 |



Drawer Light - Battery Operated Linear Light | Integrated 3 SMD LED's | 4000K | On/Off Switch | Magnet Operated | 3 x AA Batteries (Not Included) | c/w Mounting Bracket and Screws.

| Code | Wattage | Lumens | Size (mm) |
|---------|---------|--------|---------------|
| BOCL03W | 3W | 150lm | 250 x 44 x 27 |



Counter Top & Wardrobe Light - Battery Operated Linear Light | Integrated 12 SMD LED's | Integrated On/Off Switch | Magnet Operated | 12 x AA Batteries (Not Included) | c/w Mounting Kit and Screws.

| Code | Wattage | Lumens | Size (mm) |
|---------|---------|--------|---------------|
| BOCL01W | 4W | 260lm | 465 x 58 x 27 |

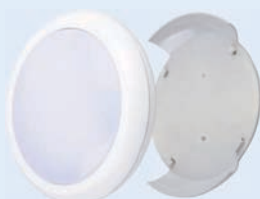

Ceiling Light - Battery Operated Spot Light | Integrated 9 SMD LED's | 4000K | On/Off Operated and push front cover | 4 x C Batteries (Not Included) | c/w Mounting Kit and Screws

| Code | Wattage | Lumens | Size (mm) |
|---------|---------|--------|-----------|
| BOCL05W | 3W | 150lm | Ø144 x 43 |



Ceiling Light - Battery Operated Spot Light | Integrated 1 SMD LED | 4000K | Light & Motion Sensor with On/Auto/Off Switch | 3 x AA Batteries (Not Included) | c/w Mounting Kit and Screws.

| Code | Wattage | Lumens | Size (mm) |
|----------|---------|--------|-----------|
| BOCL04W* | 4W | 260lm | Ø96 x 30 |

* For a set of 3 add /3 to code

LED UNDERCOUNTER / CABINET LIGHTS

Low Profile LED undercounter Lighting

Supply Voltage : 12VDC. Power Supply excluded



Features

- Polycarbonate lens and aluminium body
- Linkable, c/w power cord and mounting accessories
- 30 000 hours average lifespan
- Max length in series 1.5m
- Cool White (4000K)
- For DC power supply see page 108-109.



Touch Switch



S02-PD

On/Off Switch
Dimming

Cupboard Door Switch



S02-IR

Photo-electric Sensor
Used on doors
Light will switch on when door opens

Motion Sensor Switch



S02-PR

PIR Motion Sensor
Distance 1-3m
Time Delay 1min/5min
Selectable

| Code | Size (mm) | Power | No. of LED's | LED Type | Lumen | Spare Link |
|----------|---------------|-------|--------------|----------|-------|------------|
| L300S25 | 300 x 25 x 9 | 3W | 42 | 3528 SMD | 292lm | S25-LINK |
| L500S25 | 500 x 25 x 9 | 5W | 72 | 3528 SMD | 475lm | |
| L800S25 | 800 x 25 x 9 | 8.5W | 120 | 3528 SMD | 760lm | |
| L1000S25 | 1000 x 25 x 9 | 10.5W | 144 | 3528 SMD | 880lm | |

Low Profile LED undercounter Lighting

For corner application

Supply Voltage : 12VDC. Power Supply excluded

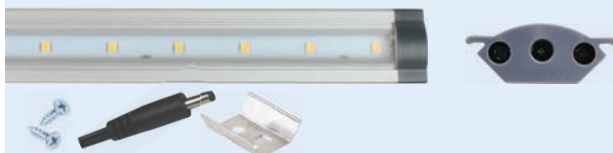

Features

- Polycarbonate lens and aluminium body
- Linkable, c/w power cord and mounting accessories
- 30 000 hours average lifespan
- Max length in series 1.5m
- Cool White (4000K)
- For DC power supply see page 108-109.



| Code | Size (mm) | Power | No. of LED's | LED Type | Lumen | Spare Link |
|----------|----------------|-------|--------------|----------|-------|------------|
| L300T27 | 300 x 27 x 11 | 3W | 42 | 3528 SMD | 292lm | T27-LINK |
| L500T27 | 500 x 27 x 11 | 5W | 72 | 3528 SMD | 475lm | |
| L800T27 | 800 x 27 x 11 | 8.5W | 120 | 3528 SMD | 760lm | |
| L1000T27 | 1000 x 27 x 11 | 10.5W | 144 | 3528 SMD | 880lm | |

LED DC LIGHT FITTINGS

Commercial

LIGHTING

| | | | | | | |
|-------------|---------------------------------------------------------------------------|-----------------------------------------------------|-----------------------------------------------------|-----------------------------------------------------|-----------------------------------------------------|------------------------------------------|
| | | | | | | |
| Code | C2-83 | C2-94 | C2-116 | C2-147 | C2-59C | C2-146 |
| LED Colour | Warm White | White | Pure White | White | White | White |
| Watts | 1.5W | 1.5W | 1W | 1.5W | 1.5W | 1.5W |
| Volts | 12-24VDC | 12-24VDC | 9-30VDC | 12-24VDC | 12-24VDC | 12-24VDC |
| Size (mm) | Ø80 x 45 | Ø80 x 48 | 115 x 77 x 48 | Ø78 x 29 | 139 x 92 x 21 | 139 x 92.5 x 21 |
| Control | Built in rocker switch On-Off control 350° swivel/40° angle adjustment | | | Built in rocker switch On-Off control | Built in rocker switch On-Off control | Built in rocker switch On-Off control |
| | | | | | | |
| Code | C2-103 | C2-138 | C2-123-CL2* | C2-123-CL4* | C2-64CAL | C2-613 |
| LED Colour | White | Cool White | Pure White | Pure White | White | White |
| Watts | 3W | 4(4 x 1W) | 2(2 x 1W) | 4(4 x 1W) | 1.2(4 x 0.5W) | 3(10 x 0.3W) |
| Volts | 12-24VDC | 9-30VDC | 9-32VDC | 9-32VDC | 12-24VDC | 12VDC |
| Size (mm) | 250 x 87 x 35 | 249 x 108 x 31 | 95 x 30 x 33 | 275 x 30 x 33 | 187 x 30 x 30 | 230 x 24 x 11 |
| Control | | Built in rocker switch On-Night-Off or On-Off | 180° Pivot. Built in rocker switch for On-Off | 180° Pivot. Built in rocker switch for On-Off | 180° Pivot. Built in rocker switch for On-Off | |

*Add fitting colour to code: ○W (White), ●BK (Black)

LED INTERIOR DC LIGHTING

| | | | | | |
|------------------------------------------------------|-------------------------------|---------------|----------------|----------------|----------------|
| Light Colour: White Supply Voltage: 9-33VDC | | | | | |
| Code | C2-212 | C2-217 | C2-218 | C2-220 | C2-221 |
| No. of LED's | 42 x SMD | 68 x SMD | 60 x SMD | 64 x SMD | 60 x SMD |
| Watts | 3W | 4W | 4W | 4W | 4W |
| Size (mm) | Ø130 x 12 | Ø180 x 12 | 200 x 120 x 19 | 185 x 150 x 12 | 220 x 100 x 12 |
| Control | Touch Control (On-Dimmer-Off) | | | | |

DC Fluorescent Light Fittings - For battery installations eg. caravans etc.

| | | | | | |
|--------------------------------------|-----------------------|------------------|----------------------|-------------------|------------------|
| Lamp included Cool White 4000K | | | 5700K | | |
| Code | C2-76 12V | C2-78 12V | C2-89 12V-LED | C2-92 12V | C2-91 12V |
| Code | C2-76 24V | C2-78 24V | C2-89 24V-LED | C2-92 24V | |
| Lamp Type | T5 | T5 | LED | T8 | T5 |
| Watts | 1 x 8W (FLT5-8) | 2 x 8W (FLT5-8) | 0,5W x 18Pcs | 1 x 15W (FLT8-15) | 1 x 8W (FLT5-8) |
| Size (mm) | 410 x 68 x 35 | 411 x 68 x 35 | 485 x 65 x 45 | 591 x 65 x 45 | 340 x 50 x 28 |
| Fitting Colour | White | White | Satin | Satin | White |
| Control | Rocker switch, On-Off | | | | |

| | | | | | |
|--------------------------------------|----------------------------------------------------------|------------------|-------------------|-----------------------|--------------------|
| Lamp included Cool White 4000K | | | | 12-24VDC 5700K | 12VDC 5700K |
| Code | C2-68 12V | C2-50 12V | C2-113 12V | C2-62-LED | C2-95-LED |
| | C2-68 24V | C2-50 24V | | | |
| Lamp Type | 2G7 | 2G7 | 2D | LED | LED |
| Watts | 1 x 13W (PL-13-WW) | 1 x 7W (PL-7-WW) | 1 x 6W (2D-16-CW) | 6W | 8W |
| Size (mm) | 254 x 70 x 37.5 | 206 x 86 x 42.2 | Ø250 x 47.5 | 186 x 179 x 37 | 200 x 120 x 40 |
| Fitting Colour | Satin | White | Satin | White | White |
| Control | On: Always on, Door: Door open Light on, Off: Always off | | | Rocker switch, On/Off | |

| | | |
|----------------------------------------------------------------------------------|------------------------------|----------------|
| <i>Ideal for steps, interior or exterior courtesy lighting and storage areas</i> | DC LED Light Fittings | |
| | | |
| | Code | C2-98-* |
| Code | C2-104-* | |
| Volts | 12-24VDC | |
| Size (mm) | 90L x 24.7W x 14.3H | |

| |
|------------------------------------------------------------------------------------------|
| Accessories |
| |
| Code |
| C2-98-B-* |
| *Add BK (Black) or CH (Chrome) bezel for C2-98. Surface mounting. LED Lamp not included. |

*Add colour to code: ● R (Red), ● BL (Blue), ● GN (Green), ● Y (Yellow), CW (Cool White)

NEW

NON-WEATHERPROOF LED STRIP LIGHTS IP20

2 Year Warranty



LD60W-R3528

5 Year Warranty



5Y-LD60W-R2835

2835 Chipset

Standard Range 12VDC | 5m | Cutting length every 3rd LED | c/w Self-Adhesive Backing | Max Length Connected in series 5m

| Code | No. of LEDs | Max Power | Lumens | *Add Colour to Code |
|----------------|-------------|-----------|--------|---------------------------------|
| IMG-R30*-S | 30/0.5m | 1.5W/m | 135lm | |
| LD30W-R3528-* | 30/m | 2.4W/m | 216lm | ●R / ●GN / ●BL / ●Y / ○WW / ○DL |
| LD60W-R3528-* | 60/m | 4.8W/m | 432lm | |
| LD120W-R3528-* | 120/m | 9.6W/m | 864lm | |
| LD240W-R3528-* | 240/m | 19.2W/m | 1728lm | |

Professional Range 24VDC | 10m | RA 80 | Cutting length every 6 LEDs | c/w Self-Adhesive Backing | Max Length connected in series 10m

| | | | | |
|-------------------|-------|--------|--------|---------------------------------|
| 5Y-LD30W-R2835-* | 30/m | 3.6W/m | 324lm | ●R / ●GN / ●BL / ●Y / ○WW / ○CW |
| 5Y-LD60W-R2835-* | 60/m | 7.2W/m | 648lm | |
| 5Y-LD120W-R2835-* | 120/m | 12W/m | 1080lm | |

5050 Chipset

Standard Range 12VDC | 5m | Cutting length every 3rd LED | c/w Self-Adhesive Backing | Max Length Connected in series 5m

| Code | No. of LEDs | Max Power | Lumens | *Add Colour to Code |
|----------------|-------------|-----------|--------|-------------------------------------------|
| LD30W-R5050-* | 30/m | 7.2W/m | 576lm | ●R / ●GN / ●BL / ●Y / ○WW / ○DL / ●●●RGBW |
| LD60W-R5050-* | 60/m | 14.4W/m | 1152lm | |
| LD120W-R5050-* | 120/m | 28.8W/m | 2304lm | |

Professional Range 24VDC | 10m | RA 80 | Cutting length every 6 LEDs | c/w Self-Adhesive Backing | Max Length connected in series 10m

| | | | | |
|------------------|------|-------|-------|------------------------------------------|
| 5Y-LD30W-R5050-* | 30/m | 5W/m | 400lm | ●R / ●GN / ●BL / ●Y / ○WW / ○CW / ●●●RGB |
| 5Y-LD60W-R5050-* | 60/m | 10W/m | 800lm | |

2 Year Warranty



LD60W-R5050

5 Year Warranty



5Y-LD30W-R5050

NEW

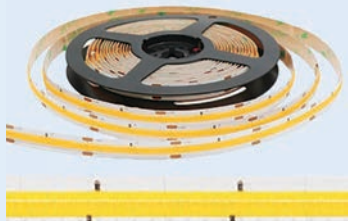

COB Strip

24VDC | 5m | Cutting length 65mm | c/w Self-Adhesive Backing | Max length connected in series 10m | 180° Beam Angle | CRI 90 | Even light distribution | No hot spots | Ideal for Architectural, Archway Bridge, Auditorium, Signage & Channel lettering

| Code | No. of LEDs | Max Power | Lumens | *Add Colour to Code |
|--------------|-------------|-----------|--------|---------------------------------|
| LD-COB-R-* | 336/m | 10W/m | 900lm | ●R / ●GN / ●BL / ●Y / ○WW / ○DL |
| LD-COB-R-RGB | 840/m | 10W/m | 900lm | ●●●RGB |

Accessories

| Code 2 Wire | Code 4 Wire | Description |
|--------------|--------------|------------------|
| LD-COB-R-2PC | LD-COB-R-4PC | Power connector |
| LD-COB-R-2MC | LD-COB-R-4MC | Middle connector |
| LD-COB-R-2JC | LD-COB-R-4JC | Jumper connector |
| LD-COB-R-2L | LD-COB-R-4L | 'L' connector |
| LD-COB-R-2T | LD-COB-R-4T | 'T' connector |
| LD-COB-R-2X | LD-COB-R-4X | 'X' connector |



Power Connector



Middle Connector



Jumper Connector



'L' Connector



'T' Connector



'X' Connector

NEW



WS2811 Addressable LED Strip

12VDC | 5m | Cutting length every 3rd LED | c/w Self-Adhesive Backing | Max length in series 5m | WS2811 is an addressable LED strip controlled by external IC WS2811 | Each IC controls 3 leds. Each pixel is individually addressable

| Code | No. LEDs | Max Power | Lumen | Colour |
|---------------|----------|-----------|-------------|--------|
| LD-WS2811-RGB | 60 | 14.4W/m | 1000-1440lm | RGB |

WEATHERPROOF LED STRIP LIGHTS IP54

2 Year Warranty



5 Year Warranty



2835 Chipset

Standard Range 12VDC | 5m | Cutting length every 3rd LED | c/w Self-Adhesive Backing | Max Length Connected in series 5m

| Code | No. of LEDs | Max Power | Lumens | *Add Colour to Code |
|----------------|-------------|-----------|--------|------------------------------------|
| IMG-OR30*-SF | 30/0.5m | 1.5W/m | 135lm | ●R / ●GN / ●BL / ●Y / ○WW / ○DL |
| IMG-WR30*-SF | 30/0.5m | 1.5W/m | 135lm | |
| LD30W-W3528-* | 30/m | 2.4W/m | 135lm | |
| LD60W-W3528-* | 60/m | 4.8W/m | 432lm | |
| LD120W-W3528-* | 120/m | 9.6W/m | 864lm | |

Professional Range 24VDC | 10m | RA 80 | Cutting length every 6 LEDs | c/w Self-Adhesive Backing | Max Length connected in series 10m

| | | | | |
|------------------|------|--------|-------|------------------------------------|
| 5Y-LD30W-W2835-* | 30/m | 3.6W/m | 396lm | ●R / ●GN / ●BL / ●Y / ○WW / ○CW |
| 5Y-LD60W-W2835-* | 60/m | 7.2W/m | 792lm | |

5050 Chipset

Standard Range 12VDC | 5m | Cutting length every 3rd LED | c/w Self-Adhesive Backing | Max Length Connected in series 5m

| Code | No. of LEDs | Max Power | Lumens | *Add Colour to Code |
|----------------|-------------|-----------|--------|----------------------------------------------------------------|
| IMG-OR15*-3SF | 30/0.5m | 1.5W/m | 120lm | ●R / ●GN / ●BL / ●Y / ○WW / ○DL / ●●● RGB / ●●●○ RGBW |
| IMG-WR15*-3SF | 30/0.5m | 1.5W/m | 120lm | |
| LD30W-W5050-* | 30/m | 2.4W/m | 192lm | |
| LD60W-W5050-* | 60/m | 4.8W/m | 384lm | |
| LD120W-W5050-* | 120/m | 28.8W/m | 2304lm | |

Professional Range 24VDC | 10m | RA 80 | Cutting length every 6 LEDs | c/w Self-Adhesive Backing | Max Length connected in series 10m

| | | | | |
|------------------|------|-------|-------|-------------------------------------------------|
| 5Y-LD30W-W5050-* | 30/m | 5W/m | 400lm | ●R / ●GN / ●BL / ●Y / ○WW / ○CW / ●●● RGB |
| 5Y-LD60W-W5050-* | 60/m | 10W/m | 800lm | |

2 Year Warranty



5 Year Warranty



WEATHERPROOF LED STRIP LIGHTS IP65

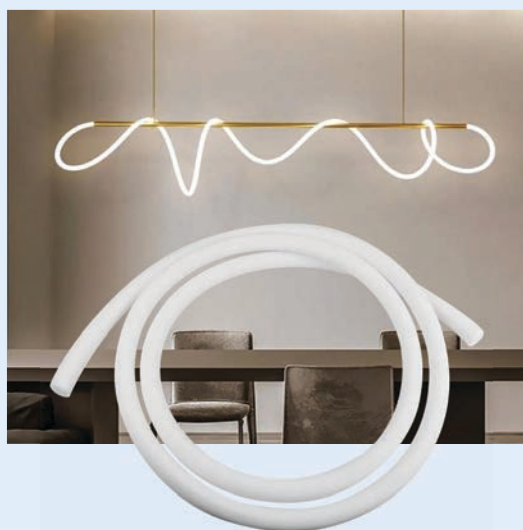

Flexible LED Tube

24VDC | 5m | Flexible | No Specific cutting length | 360° Illumination | Tube diameter 23mm

| Code | No. of LEDs | Max Power | Lumens | *Add Colour to Code |
|------------|-------------|-----------|--------|---------------------------------------------|
| DL-ECN25-* | 168 x 2/m | 14.4w/m | 1400lm | ●R / ●GN / ●BL / ●Y / ○WW / ○CW / ○DL |

Accessories

| Code | Description |
|---------------|--------------------------------------------------------------------------------------|
| DL-ECN25-FP | Straight Power out Cap and End Cap |
| DL-ECN25-SO | Side Power out Cap and End Cap |
| DL-ECN25-MC/5 | Arched shaped PC Mounting clip/5(Pack) |
| DL-ECN25-PCG | 1m Arched Shaped PC Profile |
| DL-ECN25-VC | 1m vertical PC Ceiling mount Tube c/w metal head cap, metal end cap, 1m Hanging wire |

LED PLANT GROW STRIPS IP65



Supplied with 230VAC Power Adaptor | LED Strip is 24VDC | Lumens: 10-22lm | Viewing Angle: 120° | Blue (Wave Length: 455-465nm) - Good for Photosynthesis | Red (Wave Length: 660-665nm) - Peak Wavelength for Photosynthesis & Photoperiodism - Good for Blooming & Fruits | Red/Blue in one Chip: Red:Blue = 5:1 (Suitable for most Plant Growing)

| Code | Description | No. LEDs | Max Power/m | Length |
|------------|--------------|----------|-------------|--------|
| HH-SRB60W | Red/Blue 5:1 | 60/m | 14W/m | 10m |
| HH-SRB120W | Red/Blue 5:1 | 120/m | 28W/m | 10m |
| HH-SR-60W | Red | 60/m | 14W/m | 10m |
| HH-SB-60W | Blue | 60/m | 14W/m | 10m |

NEW

ANTI-GLARE LED STRIP IP65



Input Voltage: **24VDC** - 5m Roll | 120° Viewing Angle | Even Light Distribution | Ideal for Architectural, Archway, Bridge, Auditorium, Signage & Channel Letter Lighting | Dimensions: 12 x 4.5mm | Supplied with front and back Power Connectors

| Code | No. LEDs | Max Power | Lumens | *Add Colour to Code |
|---------------|----------|-----------|--------|---------------------|
| AG210-W2835-* | 210/m | 12W/m | 1300lm | WW / CW / DL |

Accessories

| Code | Description |
|-------------|-----------------------------|
| AG210-CON | Male and Female Connector |
| AG210-CL/10 | Mounting Clips Pack of 10 |

NEW

COB LED STRIP LIGHT IP65

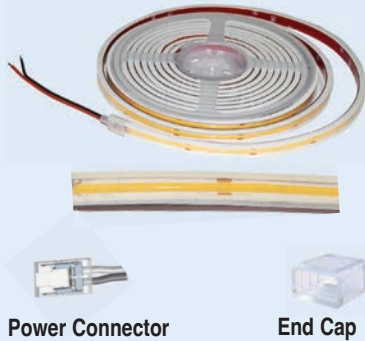

24VDC | 5m | Cutting length 65mm | c/w Self-Adhesive Backing | Max length connected in series 10m | 180° Beam Angle | CRI 90 | Even light distribution | No hot spots | Ideal for Architectural, Archway Bridge, Auditorium, Signage & Channel lettering

| Code | No. of LEDs | Max Power | Lumens | *Add Colour to Code |
|--------------|-------------|-----------|--------|-------------------------------|
| LD-COB-W-* | 336/m | 10W/m | 900lm | ●R / ●GN / ●BL / ○WW / ○DL |
| LD-COB-W-RGB | 840/m | 10W/m | 900lm | ●R ●G ●B |

Accessories

| Code 2 Wire | Code 4 Wire | Description |
|--------------|--------------|-----------------|
| LD-COB-W-2PC | LD-COB-W-4PC | Power connector |
| LD-COB-W-2EC | LD-COB-W-4EC | End Cap |

NEW

FLEXIBLE WALL WASHER STRIP LIGHT IP67



24VDC | 5m | 30° beam angle | Designed to replace traditional wall washers | Small flexible and light weight and easy to install

| Code | No LED's | Max Power/m | Lumens | *Add colour to code |
|---------------|----------|-------------|--------|---------------------|
| FW48-W30D-* | 48/m | 18W | 1915lm | WW / CW / DL |
| FW42-W30D-RGB | 42/m | 8W | 540lm | ●R ●G ●B |

Accessories

| Code | Description |
|----------|----------------------------------|
| FW-AP | 1m Aluminium channel |
| FW-AM | Angle bracket - Can adjust Angle |
| FW-MC | Metal clip for mounting |
| FW-SC | Silicone clip for mounting |
| VHB3M-18 | 3m Tape - Supplied in 1m Length |

Commercial

WEATHERPROOF LED STRIP LIGHTS IP68



2835 Chipset - **12VDC** | 5m | Silicone gel insulated tube | Min cutting length every 3rd LED | Max length connected in series 5m

| Code | No. of LEDs | Max Power | Lumens | *Add Colour to Code |
|---------------|-------------|-----------|--------|------------------------------------|
| WP30W-W3528-* | 30/m | 2.4W/m | 216lm | ●R / ●GN / ●BL / ●Y / ○WW / ○DL |
| WP60W-W3528-* | 60/m | 4.8W/m | 432lm | |

5050 Chipset - **12VDC** | 5m | Silicone gel insulated tube | Min cutting length every 3rd LED | Max length connected in series 5m

| Code | No. of LEDs | Max Power | Lumens | *Add Colour to Code |
|----------------|-------------|-----------|--------|--------------------------------------------------|
| WP30W-W5050-* | 30/m | 7.2W/m | 576lm | ●R / ●GN / ●BL / ●Y / ○WW / ○DL / ●R ●G ●B |
| WP60W-W5050-* | 60/m | 14.4W/m | 1152lm | |
| WP120W-W5050-* | 120/m | 28.8W/m | 2304lm | |

Accessories

| Code | Description | Pack Size |
|--------|-----------------------|-----------|
| SP108F | Plastic Mounting Clip | 100 |
| SP109F | End cap with no holes | 10 |
| SP110F | End cap with 2 holes | 10 |
| SP112F | 90g Silicone Gel | 10 |

LIGHTING

LED NEON FLEX

Neon LED is the state of the art LED lighting product that simulates the effect and look of neon. Also, Neon LED Strip brings back the Neon Lighting without the hassles and dangers associated with neon light. No high voltage transformers, dangerous neon gases and fragile custom glass tubes to deal with!

LED Neon Soft Jacket Flex IP65 - LED Neon Flex are soft and easily bent | Ideal for indoor & outdoor signage applications

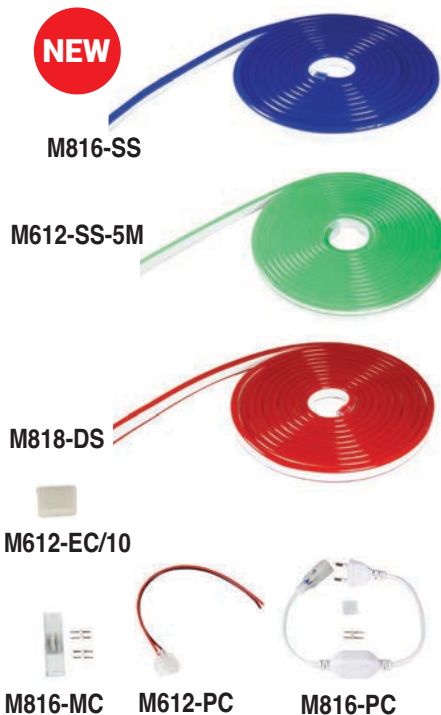

| Code | Voltage | Cutting Length | No. of LEDs P/m | Max. Power | Neon Projection | Dimensions (mm) | *Add Colour to Code |
|---------------|---------|----------------|-----------------|------------|-----------------|-----------------|-----------------------------------|
| M612-SS-5M-* | 12V | 25mm | 120 | 6W/m | Single Sided | 6(W) x 12(H) | WW / CW / ● R / ● BL / ● GN / ● Y |
| M816-SS-**-* | 230V | 1m | 120 | 8W/m | Single Sided | 8(W) x 16(H) | |
| M818-DS-**-* | 230V | 1m | 120 | 8W/m | Double Sided | 8(W) x 18(H) | |
| M1020-SS-RGBW | 12V | 50mm | 120 | 10W/m | Single Sided | 10(W) x 20(H) | ● ● ● ○ RGBW |

* Add Length to Code: 5M (5 Meters), 50M (50 Meters)

Accessories

| Code M612 | Code M816 | Code M818 | Code M1020 | Description |
|------------|------------|------------|-------------|-------------------------|
| M612-PC | M816-PC | M818-PC | M1020-PC | Power Connector |
| - | M816-MC-D | M818-MC-D | M1020-MC-D | Middle Connector |
| M612-MC | M816-MC | M818-MC | M1020-MC | Middle Jumper Connector |
| M612-EC/10 | M816-EC/10 | M818-EC/10 | M1020-EC/10 | End Cap |
| M612-30PVC | M816-30PVC | - | M1020-30PVC | 300mm PVC Channel |
| M612-1ALU | M816-1ALU | - | M1020-1ALU | 1m Aluminium Channel |
| M612-2ALU | - | - | - | 2m Aluminium Channel |
| - | - | M818-CL/10 | - | Plastic Mounting Clips |

Wide Profile LED Neon Strip IP65 - 5m Rolls | The Neon Strip can fit perfectly around curved surfaces, closely following the contour with the use of mounting clips at strategic points. This provides accent lighting whenever you require it, and the variety of colours available provides further opportunity to exercise creativity.

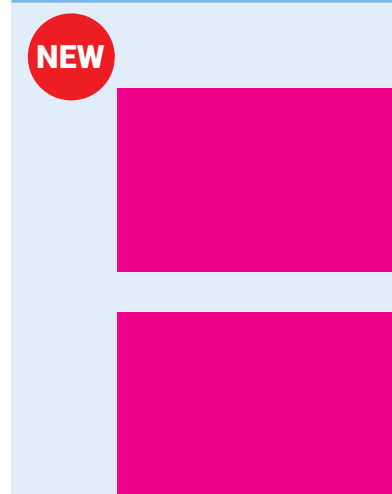

| Code | Voltage | Cutting Length | No. of LEDs P/m | Max. Power | Neon Projection | Dimensions (mm) | *Add Colour to Code |
|---------------|---------|----------------|-----------------|------------|-----------------|-----------------|----------------------------------|
| LDM-3020-5M-* | 24VDC | | 240 D/Row | 18W/m | Single Sided | 30 x 20 | WW / CW / DL / ● R / ● BL / ● GN |

Accessories

| Code M612 | Description |
|-------------|------------------|
| LDM-3020-PC | Power Connector |
| LDM-3020-MC | Middle Connector |
| LDM-3020-EC | End Cap |
| LDM-3020-CL | Mounting Clips |

Frosted Jacket Neon Flex IP65 - 5m Length | c/w Power Cord



| Code | Voltage | Cutting Length | No. of LEDs P/m | Max. Power | Neon Projection | Dimensions (mm) | *Add Colour to Code |
|------------|---------|----------------|-----------------|------------|-----------------|-----------------|----------------------------------------|
| LR2131-S-* | 230V | 25mm | 120 | 6W | Single Sided | 8(W) x 16(H) | WW / CW / DL / ● R / ● BL / ● GN / ● Y |

DIY Shaping LED Neon Strip IP67 - Blister Pack | 5m Roll | The LED Neon Flex is designed to shape into any form without the need of clips or profile to hold the shape | c/w 1pcs power connector, & 15pcs mounting screws.



| Code | Voltage | Cutting Length | No. of LEDs P/m | Max. Power | Neon Projection | Dimensions (mm) | *Add Colour to Code |
|-----------------|---------|----------------|-----------------|------------|-----------------|-----------------|----------------------------------------|
| LR1131-DIY-5M-* | 12VDC | | 120 | 24W/m | Single Sided | 6 x 12 | WW / CW / DL / ● R / ● BL / ● GN / ● Y |

LED NEON FLEX

LED Neon Flex Colour Jacket IP65 - Supplied in two lengths: 10m & 50m | c/w 1 x Power Cord, 1 x Middle Connector, 1 x End Cap, 5pcs Aluminium Mounting Clips

| Code | Voltage | Cutting Length | No. of LEDs P/m | Max. Power | Neon Projection | Dimensions (mm) | *Add Colour to Code |
|----------------|---------|----------------|-----------------|------------|-----------------|-----------------|--------------------------------|
| MLN-FX-**-240V | 230V | 1m | 48 | 4W | Single Sided | 11(W) x 24(H) | ● R / ● B / ● G / ● Y / ● O |

* Add Length to Code: **10** (10m Length), **50** (50m Length)

* Add Colour to Code: ● **R** (Red), ● **G** (Green), ● **B** (Blue), ● **O** (Orange), ● **Y** (Yellow)

10 meter is supplied with: 1 power cord; 1 x 1.6A converter 240VAC/24VDC; 1 x middle joint connector; 1 x end cap; 5pcs aluminium mounting clips | 50 meters supplied as 10 meters x 5

Accessories

| Code | Description |
|----------------|-------------------------------------|
| MLN-FX-CA-1.6A | 1.5m Power cable for 10m Neon Strip |
| MLN-FX-CA-4A | 1.5m Power cable for 50m Neon Strip |
| MLN-FX-CA-3 | Coupling with shrink tube (Joining) |
| MLN-FX-CA-5 | 5 x End Caps |
| MLN-FX-5 | 50mm Aluminium Mounting Clip |



MLN-FX-CA-1.6A



MLN-FX-CA-3

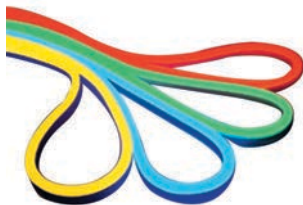

LED Neon® Flex IP65 - High brightness LED chips encased in a unique PVC Jacket | As a result of our propriety optical technology, this elaborately designed jacket can greatly enhance the intensity and uniformity of the light

| Code | Voltage | Cutting Length | No. of LEDs P/m | Max. Power | Neon Projection | Dimensions (mm) | *Add Colour to Code |
|------------------------|---------|----------------|-----------------|------------|-----------------|-----------------|---------------------|
| LNFX- *SB -240V | 230V | 0.91m | | 6.6W/m | Single Sided | | |
| LNFX- *R -240V | 230V | 1.52m | | 4.7W/m | Single Sided | | |
| LNFX- *B -240V | 230V | 0.91m | | 6.6W/m | Single Sided | | |
| LNFX- *G -240V | 230V | 0.91m | | 6.6W/m | Single Sided | | |
| LNFX- 100 -240V | 230V | 1.52m | | 4.7W/m | Single Sided | | |
| LNFX- *Y -240V | 230V | 1.52m | | 4.7W/m | Single Sided | | |
| LNFX- *M -240V | 230V | 0.91m | | 6.6W/m | Single Sided | | |

*Add length to code: **5** (5 Meters), **10** (10 Meters), **50** (50 Meters)

5/10m is supplied with: 1 x Power Cord, 1 x 1.6A Converter AC/DC, 1 x Middle Joint Connector, 1 x End Cap, 5pcs Mounting Clips, 50m Supplied as 5 x 10m x 5

Accessories

| Code | Description |
|---------|----------------------------------------------------|
| FX-1.6A | Power Cable 1.5m Width 1.6A Converter + 2 Pin Plug |
| FX-10A | Power Cable 1.5m Width 10A Converter + 2 Pin Plug |
| FX-3 | Coupling with Shrink Tube (joining kit) |
| FX-4 | End Cap |



FX-1.6A



FX-3

NEW

SMART LED STRIP KIT IP54



Smart WiFi LED Strip Kit - 5m - c/w Controller & 230VAC Power Supply

| Code | Function | No. of LEDs/m | Watts/m | Max Power |
|-------------------|-------------|---------------|---------|-----------|
| ES-WFD01-5M-CW/WW | CCT Adj ○○○ | 120/m | 4.8W/m | 24W |
| ES-WFD02-5M-RGB | RGB ●●● | 30/m | 4.8W/m | 24W |
| ES-WFD03-5M-RGBW | RGBW ●●●○ | 48/m | 4.8W/m | 24W |

● R (Red), ● GN (Green), ● BL (Blue), ○ W (White)

SMART ADRESSABLE LED STRIP KIT IP65



RGB WiFi Addressable LED Strip kit - 5m

Complete Kit with 5m Strip, smart controller, 230VAC Power Adaptor and IR Remote controller | c/w Self-Adhesive Back with double side tape | Each LED is individually addressable

| Code | No. LED | Max Power | Colour |
|-----------------|---------|-----------|-----------------|
| HH-RGBIC3010-L5 | 30 | 4.8W/m | ●●● Digital RGB |

● R (Red), ● GN (Green), ● BL (Blue), ○ W (White)

SMART COB LED STRIP LIGHT KIT IP40



COB Strip kit - 5m

Smart controller, remote controller and 230VAC Power adaptor

| Code | Function | No. of LEDs/m | Watts/m | Max Power |
|---------------------|-------------|---------------|---------|-----------|
| HH-COB640-CCT-L5 | CCT Adj ○○○ | 640 | 7W/m | 35W |
| HH-COB630210-RGB-L5 | RGB ●●● | 630 | 7W/m | 36W |

● R (Red), ● GN (Green), ● BL (Blue), ○ W (White)

SMART WIFI NEON STRIP LIGHT IP67



Note: Kit Includes IR remote controller, Smart Controller, Neon Strip and 230VAC Power Adaptor















| Code | Length | Function | No. of LED | Watts/m | Side Size |
|--------------------|--------|-----------------|------------|---------|-----------|
| HH-RGBWW1801220-L5 | 5m | RGBW ●●●○ | 180/m | 7W/m | 12 x 20mm |
| HH-RGBIC60SN-L3 | 3m | Digital RGB ●●● | 72/m | 7W/m | 8 x 16mm |

● R (Red), ● GN (Green), ● BL (Blue), ○ W (White)

NEW

NEON LED WALL LIGHT KITS

Decorative Neon Wall Art | 3X AAA | batteries (not incl.) | USB

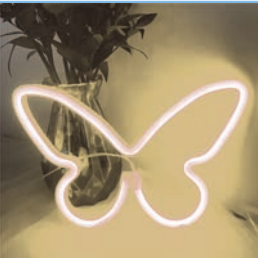
| | | | | |
|-------------|-------------------------------------------------------------------------------------|-------------------------------------------------------------------------------------|--------------------------------------------------------------------------------------|---------------------------------------------------------------------------------------|
| |  |  |  |  |
| Code | HH-NWL01 | HH-NWL02 | HH-NWL03 | HH-NWL06 |
| Description | Bulb | Lip | Love | Hello |
| Colour | RGB | Red | RGB | White + Pink |
| Size (mm) | 260 x 165 x 20 | 280 x 250 x 20 | 350 x 130 x 20 | 300 x 210 x 20 |
| |  |  |  |  |
| Code | HH-NWL07 | HH-NWL08 | HH-NWL11 | HH-NWL12 |
| Description | Yeah | Love Heart | Heart | Shooting Star |
| Colour | Red | White + Pink | Red | White + Blue |
| Size (mm) | 350 x 180 x 20 | 270 x 255 x 20 | 315 x 275 x 20 | 300 x 180 x 20 |
| |  |  |  |  |
| Code | HH-NWL13B | HH-NWL15 | HH-NWL19 | HH-NWL25 |
| Description | Lightning | Star | Rainbow | Flamingo |
| Colour | Pink + Blue | Warm White | Red + Orange + Yellow + Green + Blue | Pink |
| Size (mm) | 340 x 130 x 20 | 280 x 280 x 20 | 300 x 170 x 20 | 290 x 140 x 20 |
| |  |  |  |  |
| Code | HH-NWL26 | HH-NWL27 | HH-NWL28 | HH-NWL29E |
| Description | Unicorn | Reindeer | Cat | Butterfly |
| Colour | Warm White | RGB | Blue | Warm White |
| Size (mm) | 250 x 160 x 20 | 270 x 240 x 20 | 230 x 180 x 20 | 325 x 160 x 20 |

Commercial

LIGHTING

NEW

NEON LED WALL LIGHT KITS

Decorative Neon Wall Art | 3X AAA | batteries (not incl.) | USB

| | | | | |
|-------------|-------------------------------------------------------------------------------------|-------------------------------------------------------------------------------------|--------------------------------------------------------------------------------------|---------------------------------------------------------------------------------------|
| | |  |  |  |
| Code | | HH-NWL31 | HH-NWL32 | HH-NWL33 |
| Description | | Dolphin | Whale | Dinosaur |
| Colour | | Blue | Blue | Green |
| Size (mm) | | 190 x 155 x 20 | 190 x 160 x 20 | 190 x 180 x 28 |
| |  |  |  |  |
| Code | HH-NWL35 | HH-NWL36 | HH-NWL38E | HH-NWL40 |
| Description | Snoopy | Mickey | High-Heeled Shoes | Cactus |
| Colour | Cool White | Red | Blue | Green+Orange |
| Size (mm) | 240 x 170 x 20 | 240 x 170 x 20 | 200 x 240 x 20 | 340 x 180 x 20 |
| |  |  |  |  |
| Code | HH-NWL41 | HH-NWL42 | HH-NWL43 | HH-NWL44 |
| Description | Christmas Tree | Bell | Snow | Christmas Stocking |
| Colour | Green | Warm White | Cool White | Red + White |
| Size (mm) | 240 x 180 x 20 | 300 x 230 x 20 | 250 x 250 x 20 | 250 x 190 x 20 |

Commercial

LIGHTING

230VAC LED STRIP LIGHTS



Blister Pack



Reel

High Voltage Strip Light IP67 - Does not require power supply | Can run up to 50 meters without voltage drop | Cutting mark every 1m | 180° Beam Angle | UV Protected Housing

| Code | No. of LEDs | Max. Power | Lumens | *Add Colour to Code |
|---------------------------------|-------------|------------|---------|---------------------|
| Supplied in Blister Pack | | | | |
| HV60W-W3528-*-* | 60/m | 4.8W/m | 336lm/m | WW / DL / ● R |
| HV30W-W5050-*-* | 30/m | 7.2W/m | 432lm/m | / ● BL / ● GN |
| HV60W-W5050-*-* | 60/m | 14.4W/m | 864lm/m | / ● Y |

* Add Length to Code: **1M** (1 Meters), **5M** (5 Meters)

| Code | No. of LEDs | Max. Power | Lumens | *Add Colour to Code |
|-------------------------|-------------|------------|---------|---------------------|
| Supplied on Reel | | | | |
| HV60W-W3528-*-* | 60/m | 4.8W/m | 336lm/m | WW / DL / ● R / |
| HV30W-W5050-*-* | 30/m | 7.2W/m | 432lm/m | ● BL / ● GN / |
| HV60W-W5050-*-* | 60/m | 14.4W/m | 864lm/m | ● Y / ● ● RGB |

* Add Length to Code: **10M** (10 Meters), **50M** (50 Meters)

NEW



High Voltage COB Strip Light IP67 - 230VAC | 280 LED high density FOB linear flexible LED rope | Cutting mark 500mm | 180° Beam Angle | UV Protected Housing

| Code | No. of LEDs | Max. Power | Lumens | *Add Colour to Code |
|------------|-------------|------------|----------|--------------------------------------------------|
| HV-COB-*-* | 288/m COB | 12W/m | 1080lm/m | CW / WW / DL / ● R / ● BL / ● GN / ● Y / ● ● RGB |

* Add Length to Code: **5M** (5 Meters), **50M** (50 Meters)

NEW



FSW-120X2835-10M

FSW-180X2835-*

High Voltage Strip on Extension Reel IP65 - 230VAC | c/w power connector | Ideal for work, functional and decorative lighting

| Code | No. of LEDs | Max. Power | Lumens | Temp |
|------------------|-------------|------------|----------|-------|
| FSW-120X2835-10M | 120/m | 9W/m | 810lm/m | 6500K |
| FSW-180X2835-* | 120/m | 12W/m | 1100lm/m | 6500K |

* Add Length to Code: **15M** (15 Meters), **25M** (25 Meters), **50M** (50 Meters)

Commercial

Accessories



HV-WIRE-3528
HV-WIRE-5050

HV-WIRE-RGB



HV-RGB-RC



HV-CON-3258/5
HV-CON-5050/5



HV-CON-RGB/5



HV-EC-3528/10
HV-EC-5050/10



HV-CLIP-3528/10
HV-CLIP-5050/10

| Code (Blister Pack) | Code (Reel) | Code (COB) | Description |
|---------------------|-----------------|----------------|-----------------------------------------------|
| HV-WIRE-3528 | HV-WIRE-3528 | - | 3528 Power Cord 100m Max |
| HV-WIRE-5050 | HV-WIRE-5050 | - | 5050 Power Cord 50m Max |
| - | - | HV-COB-PC | |
| - | HV-WIRE-RGB | HV-COB-RGB | Power Cord for RGB Strip c/w Basic Controller |
| - | HV-RGB-RC | HV-COB-M-RGB | Multifunction RGB Controller and Remote |
| HV-CON-3258/5 | HV-CON-3528/5 | - | 3528 Middle Connector Pack of 5 |
| HV-CON-5050/5 | HV-CON-5050/5 | - | 5050 Middle Connector Pack of 5 |
| - | - | HV-COB-MC | Middle Connector pack of 5 |
| - | HV-CON-RGB/5 | HV-COB-CON-RGB | RGB Middle Connector pack of 5 |
| HV-EC-3528/10 | HV-EC-3528/10 | - | 3528 End Cap Pack of 10 |
| HV-EC-5050/10 | HV-EC-5050/10 | - | 5050 End Cap Pack of 10 |
| - | - | HV-COB-EC/10 | End Cap Pack of 10 |
| HV-CLIP-3528/10 | HV-CLIP-3528/10 | - | 3528 Mounting Clip Pack of 10 |
| HV-CLIP-5050/10 | HV-CLIP-5050/10 | - | 5050 Mounting Clip Pack of 10 |
| - | - | HV-COB-CLIP/10 | COB Mounting Clip Pack of 10 |

LIGHTING

NEW

STAIRWAY LIGHTING CONTROLLERS



MLU300-IR-WR

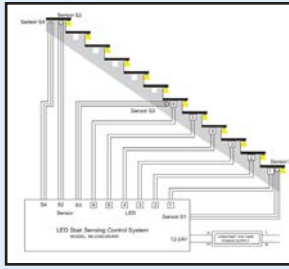

ELU300-D1-IR

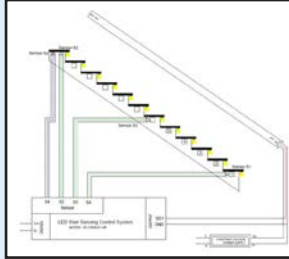

DMX Stair Case Lighting - The DMX controller is used for Dynamic Lighting of the stairs. The back light is switched on with the subsequent step, depending on motion direction: ascending or descending

Controller

| Code | Input/Output Voltage | Input Signal Channels | Output Channels | Size |
|--------------|----------------------|-----------------------|-----------------|---------------|
| MLU300-IR-WR | 12-24VDC | 4 | 50 Max | 168 x 39 x 30 |

Decoder

| Code | Input/Output Voltage | Input Signal Channels | Output Channels | Size |
|-------------|----------------------|-----------------------|-----------------|---------------|
| MLU500-3-8A | 12-24VDC | 4 | 3 | 168 x 39 x 30 |
| MLU500-4-8A | 12-24VDC | 4 | 4 | 168 x 39 x 30 |
| MLU500-5-8A | 12-24VDC | 4 | 5 | 168 x 39 x 30 |

Pixel Handrail Lighting - The LED Handrail controller is used to create a meteor effect on the handrail. The effect will depend on motion direction: ascending or descending. Only Compatible with WS2811 IC LED Strip

Controller

| Code | Input/Output Voltage | Input Signal Channels | Output Channels | Size |
|--------------|----------------------|-----------------------|-----------------|---------------|
| ELU300-D1-IR | 12VDC | 4 | 1 | 168 x 39 x 30 |

Accessories

| Code | Description |
|------------|-------------------------------------------|
| MLS008-PIR | Motion Sensor - Used to trigger direction |
| MLS008-BRC | Day light sensor |
| IR-K2 | IR Remote Control - Program Scenes |



SMART LED STRIP LIGHT DIMMER & CONTROLLERS IP20



ES-TDS01



ES-WDS01



Touch (On / Off & Dimming) - Metal body | Touch time < 2 seconds, on / off function | Touch time > 2 seconds, dimming will gradually rise to full brightness alternatively lower brightness

Wave (On / Off & Dimming) - Wave your hand in front of dimmer | Waving time < 2 seconds, on / off function | Touch time > 2 seconds, dimming will gradually rise to full brightness alternatively lower brightness

| Code Touch | Code Wave | Input Voltage | Function | Max. Power |
|------------|-----------|---------------|---------------|------------------------------|
| ES-TDS01 | ES-WDS01 | DC12V / DC24V | Single Colour | 36W at DC12V 72W at DC24V |



IR Sensor

IR Sensor Switch - Normally mounted in wardrobe and drawer | Open door , light ON | Close door , light OFF

| Code | Input Voltage | Function | Max. Power |
|----------|---------------|---------------|------------------------------|
| ES-IRS03 | DC12V / DC24V | Single Colour | 36W at DC12V 72W at DC24V |



ES-BDS01

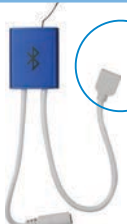

ES-BDS02



ES-BDS03



Bluetooth Controller - Bluetooth 4.1 | Support IOS & Android | Download "Wilight" from Apple Store or Google Play | Search the connected light | Control the light by "Wilight" App

Wi-Fi Controller - Remote control LED lamps by App | Support 16 million colour selection and brightness control | Timing function, set schedule to switch on/off lights | Colour change with rhythm of music on smart device | Works with Amazon Alexa & Google home, control lights by voice

| Code Bluetooth | Code Wi-fi | Input Voltage | Function | Max. Power |
|----------------|------------|---------------|---------------|------------------------------|
| ES-BDS01 | ES-WFD01 | DC12V / DC24V | Single Colour | 36W at DC12V 72W at DC24V |
| ES-BDS02 | ES-WFD02 | DC12V / DC24V | RGB | 36W at DC12V 72W at DC24V |
| ES-BDS03 | ES-WFD03 | DC12V / DC24V | RGBW | 36W at DC12V 72W at DC24V |



ES-WFD01



ES-WFD02



ES-WFD03



CONTROLLERS FOR LED STRIPS

| Code | MINI-RGB | MINI-RGBW | MINI-SINGLE | MINI-AMP | MINI-WIRELESS-RGB | MINI-WIRELESS-RGBW | RGB-LINK/5 |
|-------------|-------------------------|---------------------------------------|---------------------------------------|---------------------------------------------|--------------------------------|---------------------------------|----------------|
| Description | 12VDC Colour Controller | 12VDC Single Colour Controller Dimmer | 12VDC Single Colour Controller Dimmer | RGB LED Amplifier to be used every 5 meters | RF Wireless RGB LED Controller | RF Wireless RGBW LED Controller | 4 Pin RGB Link |
| Watts | Max 144W | Max 144W | Max 144W | - | Max 144W | Max 144W | - |

| Code | SP106F | RGBW-AMP | GT-2601 | WD95-DC12 | WLD95-DC12 | DC-PWM-96W-LED |
|--------------|------------------------|------------------------------------------|-------------------------------|-----------------------|--------------------------|-----------------------------------------------------------------------------------------------------------------------------------------------|
| Supply Volts | 12VDC | 12 - 24VDC | 12VDC | 12VDC | 12-24VDC | 9VDC-48VDC |
| Description | RGB Amplifier 48W (4A) | RGBW Amplifier 4 Channel, 6A per Channel | RGB Controller 6A per Channel | Wired dimmer 96W (8A) | Wireless dimmer 48W (4A) | No minimum load Suitable for 12VDC and 24VDC strip LED's Digital control provides accurate and flicker free dimming to very low intensity |
| Size (mm) | 104 x 65 x 24 | 115 x 72 x 42 | 105 x 75 x 29 | 89 x 59 x 35 | 65 x 39 x 22 | 36 x 36 x 12 |

DC PWM Bell Press Dimmer - Ideal for LED Strip Light I for zone controlling see dimmer section in accessories.

NEW



| Code | SP107F | FUT-005N | FUT-022 | FUT-025 | RGBW-CON |
|--------------|-------------------------------------------------------------------------------------------------------------------------------|------------------------------------------------------------------------------------------------------------------------------------------------------------------|-------------------------------------------------------------|---------------------------------------------------|-----------------------------------------------------|
| Supply Volts | 12/24VDC | 12/ 24VDC | 12-24VDC | 12-24VDC | 12-24VDC |
| Description | RGB Controller with remote for preloaded programs (Fading & Flashing effects) 45 Watts (4A) per channel. 9 Changing Patterns. | LED RGB Controller with remote control. Dimming function & 15 colour changing patterns set via remote. 6A per channel. Direct colour selection via colour wheel. | Colour temperature adjustable and dimmable. 6A per Channel. | RGB Colour changing and dimmable. 6A per Channel. | RGB+W Colour changing and dimmable. 6A per Channel. |

SMART DEVICES



HOME-MINI



ECHO DOT

Google Home Mini

Powered by the Google Assistant so you can ask it questions and tell it to perform various tasks. Enjoy your entertainment and control your Smart Home.

| Code | Wireless Network | Colour | Size (mm) |
|-----------|------------------|--------------|-----------|
| HOME-MINI | WIFI & Bluetooth | White / Grey | Ø98 x 42 |

Echo Dot

A hands-free, voice controlled device that uses Alexa to play music, control smart home devices and more

| ECHO-DOT | WIFI & Bluetooth | Black | Ø84 x 32 |
|----------|------------------|-------|----------|
|----------|------------------|-------|----------|

DIGITAL & MUSIC STRIP LIGHTS



Music Activated LED Strip RGB Kit IP65 - c/w Music Controller, RGB Controller and 230VAC Power Supply

| Code | No. LEDs / m | Max Power / m | Length |
|----------------|--------------|---------------|--------|
| MUS30-5050-RGB | 30 | 5W / m | 5m |

SMART LED STRIP KIT



Smart Wi-Fi LED Strip kit - 5m Length

| Code | Function | No. of LEDs/m | Watts/m | Max Power |
|-------------------|----------|---------------|---------|-----------|
| ES-WFD01-5M-CW/WW | CCT Adj | 120/m | 4.8W/m | 24W |
| ES-WFD02-5M-RGB | RGB | 30/m | 4.8W/m | 24W |
| ES-WFD03-5M-RGBW | RGBW | 48/m | 4.8W/m | 24W |



WiFi Control

App Control

Remote Switching

Set Timers & Schedules

Dimmable

Music for RGB/RGBW

Colour RGBW Adjustable

LED FLEX STRIP KITS - 5M LENGTHS

IP20



c/w power supply & ON/OFF switch

IP65



c/w dimmer & CW/WW control

IP65



c/w RGB remote controller

NEW

IP20



c/w RGB remote controller

NEW

| Code | LS1761P-* | LS1778-CW/WW | LS1702P-RGB | LS1702P-RGBW | NW1702P-RGBW |
|-----------|-----------------------------------------------------------------------------------------------------------|-----------------------------------------|------------------------------|-------------------------------------|-------------------------------------|
| Size (mm) | 5000L x 8W x 4H | 5000L x 14W x 4H | 5000L x 14W x 4H | 5000L x 14W x 4H | 5000L x 14W x 4H |
| Lumen | 900 - 1050lm | 1400lm | N/A | N/A | N/A |
| LEDs | 60/m (total 300Pcs 24W) 3528 | 60/m (total 300Pcs 48W) 3528 | 30/m (total 150Pcs 36W) 5050 | 30/m (total 150Pcs 36W) 5050 | 30/m (total 150Pcs 36W) 5050 |
| Colour | *Add colour to code: ○ CW (5000k), ○ WW (3200k), ● R (Red), ● GN (Green), ● BL (Blue), ● Y (Yellow) | ○ CW (Cool White), ○ WW (Warm White) | ●●● RGB (Red, Green, Blue) | ●●●○ RGBW (Red, Green, Blue, White) | ●●●○ RGBW (Red, Green, Blue, White) |

HEXAGON LED TILES



Tiles - Wifi enabled | Touch Control | Music Sync | Screen Mirror | 100lms per panel | CRI >80 | RGBW 1200K-6500K, + 16 million colours | Dimmable | Mounting Type : double sided Tape or Mounting Screws | Compatible with Apple, Amazon, Google, IFTTT, Smarthings | Create any patterns by interlinking

| Code | Max Power Supply Power | Max Energy Consumption per Panel | Max Power per Power Supply | Max Panels per controller | Dimmension |
|---------------|------------------------|----------------------------------|----------------------------|---------------------------|------------|
| NL42-0001HX-P | 42W | 2W | 21 hexagons per 42W PSU | 500 Hexagons | Ø230x10mm |

Accessories

| Code | Description |
|---------------|-----------------------------|
| NL42-0002HX-C | Smart Controller |
| NL26-0001 | Remote Control |
| NC04-0051 | 230VAC 42W Power Supply |
| NC04-0070 | Linking Cables (3 per pack) |
| NC04-0042 | Rigid Links (10 per pack) |



NL42-0001MX-P



L26-0001



NL42-0002HX-C



NC04-0051



NC04-0070



NC04-0042

LED UNDER BED STRIP WITH MOTION SENSOR



FST-CDB

Rechargeable - USB Port for Charging | Working Time 3hrs | Motion Sensor Distance: 2-5m | Time Adjustable 15sec - 6min

| Code | Wattage | Lumens | LED p/m | Length |
|--------------|---------|--------|---------|--------|
| FST-CDB-1M-* | 2.4W | 240lm | 30 | 1m |

* Add colour to code: ○ **WW** (Warm White) 2700K, ○ **CW** (Cool White) 4200K, ○ **DL** (Daylight) 6000K

Direct 230V - Dimmable | Motion Sensor Distance: 2-5m | Time Adjustable 30s - 380s | Colour Temperature: Warm White 2700K

| Code | Wattage | Lumens | LED p/m | Length |
|-----------------|---------|--------|---------|----------|
| BL60-W3528-WW/2 | 2.8W | 260lm | 45 | 1.5m |
| BL60-W3528-WW/2 | 2.8W | 260lm | 45 | 2 x 1.5m |



BL60-W3528-WW/2



BL60-W3528-WW

USB MULTI COLOUR MOOD LIGHT FOR TV IP20

USB Power 5VDC | Easy Assembly | Remote Control | Two Available Options, 2 LED Strips or 4 LED Strips per Controller

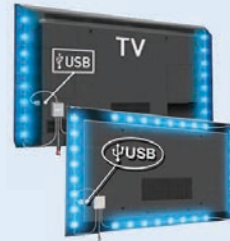

| Code | Wattage | Lumens | LED/m | Length (mm) |
|-------------------|---------|--------|-------|----------------------|
| TV30-R5050-RGBW/2 | 4.8W/m | 300lm | 32 | 2 x 500 (2 x Strips) |
| TV30-R5050-RGBW/4 | 9.6W/m | 600lm | 32 | 4 x 500 (4 x Strips) |

LED TAIL LIGHT STRIP IP67

Input Voltage: 12VDC | 4 Pin tow adaptor connection | Flexible design | Adventure Proof | LED Signals: Driving mode - Glows bright red, Left Turn - Flash on the left, Right Turn - Flash on the right, Break - Beam dark red across, Reverse - Beam White across.



| Code | Wattage | LED p/m | Size (mm) |
|---------------|---------|---------|-------------|
| TG60-2835-R/W | 1.2W | 60 | 13 x 6 1244 |

UNDER DASH LIGHTING KIT

Input Voltage: 12-24VDCVDC | c/w Cigarette Lighter Adaptor | 4 x Waterproof LED Strips - RGB | Wireless IR Remote & Controller | Dimmable | Colour Scenes



| Code | Description | Wattage | LEDs | Size (mm) |
|--------------|--------------------------------------------------------|---------|--------|-----------|
| UD-5050-RGB | Colour Changing c/w controller | 18W | 18 x 4 | 300 x 10 |
| UD-5050-RGBM | Colour Changes to the Beat of the Music c/w controller | 12W | 12 x 4 | 210 x 10 |

Commercial

LIGHTING

GAZEBO LIGHT KIT

Input Voltage: 5VDC | 160° Beam Angle | Colour Temperature: 5000K | c/w Mounting Clips | 4 x 3 Meter light strips | On/Off Switch | Easy to Assemble



Ideal for Camping

| Code | Description | Wattage | Lumens | Size (mm) |
|----------|---------------------|---------|--------|-------------|
| SG-TLKA1 | Gazebo 5VDC LED Kit | 4 x 3W | 1500lm | 4000 x 3000 |

CAMPING LED STRIP LIGHT IP68



Input Voltage: 5V / 12VDC | One Side with USB, other side with waterproof DC female connector with cigarette & battery clip | Two mounting methods, hook & velcro | Dimmable | 4 Different colour methods; Warm White, Cool White, R+G+B (SOS) & Amber to keep insects away.

| Code | Wattage | Lumens | LED/m | Length (mm) |
|--------------------|---------|--------|---------|-------------|
| KU-CAMPSTRIP-12VDC | 10W | 500lm | 60 + 30 | 1000mm |

LED STRIP CONNECTION SYSTEM

| | LED Strip | Right Bend | Left Bend | Tee | Cross |
|-------------|----------------------------------------------------------------|--------------------------------------|--------------------------------------|------------------------------------|------------------------------------|
| Code | SL101- [*] - [*] SL102- [*] -RGB | SL-CL11- [*] SL-CL21-RGB | SL-CL12- [*] SL-CL22-RGB | SL-CT1- [*] SL-CT2-RGB | SL-CC1- [*] SL-CC2-RGB |
| No. of LEDs | 9/18 | 2 | 2 | 3 | 3 |
| Power | 1.4W/2.8W | 0.5W | 0.5W | 0.5W | 0.5W |
| Size (mm) | 250/500 x 9.8 | 45 x 21 | 45 x 21 | 56 x 45 | 56 x 56 |

* Add size to code: 250mm or 500mm. *Add colour to code: ● R (Red), ● Y (Yellow), ● GN (Green), ● BL (Blue), ○ PW (Pure White)

Application

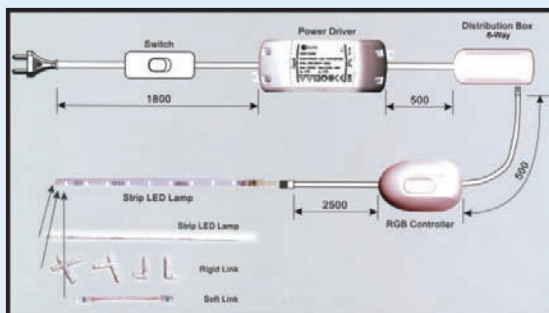

| Code | Description |
|------------|---------------------------------------------------------------------------|
| ED1230 | Power driver 12V 25W max |
| SL-C10 | RGB controller (10 functions) |
| SL-DB6-C | 6-Way distribution box for use with single colour LED strips |
| SL-DB6-RGB | 6-Way distribution box for use with RGB LED strips |
| SL-DB12 | 12-Way distribution box for use with LED spot lights |
| SL-SC | Soft link for connecting LED strips to each other (80mm long) |
| SL-IC | Initial connector for connecting LED strips to power driver (2500mm long) |



FLEXIBLE SILICONE PROFILE

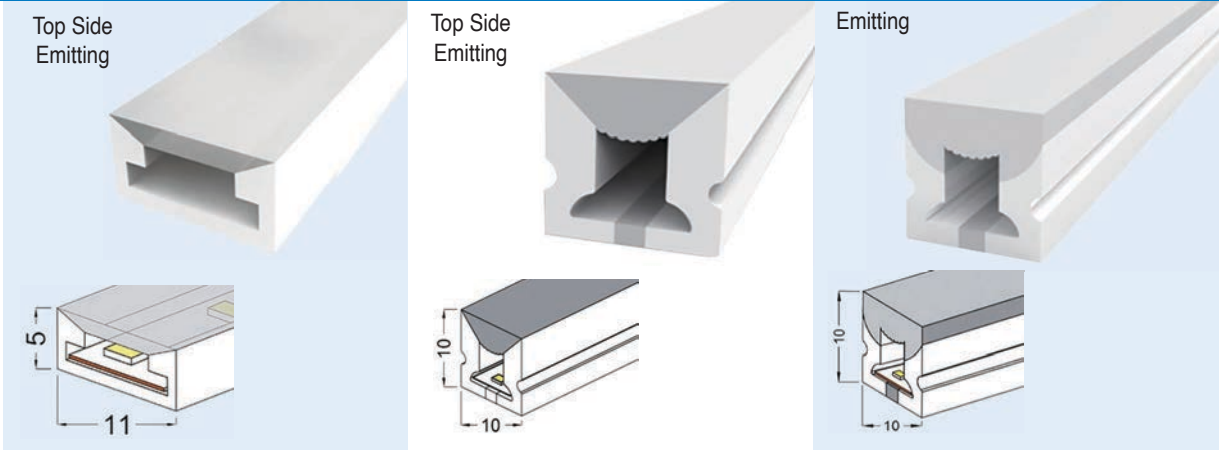

| Code | SIL-5X11-FRONT/10M | SIL-10X10-FRONT/10M | SIL-10X10-3SIDES/10M |
|----------------------|--------------------|---------------------|--------------------------|
| Length | 10m | 10m | 10m |
| LED Strip Dimensions | 8mm | 5mm | 5mm |
| Power Sleeve | SL-0511-SPS | SL-1010A-SPS | SL-1010B-SPS |
| End Cap | SIL-5X11-CLIP/10 | SL-1010A-EC | SIL-10X10-CAP |
| Mounting Clips | SIL-5X11-CAP/5 | - | SIL-10X10-CLIP |
| 30mm Alu. Profile | - | SL-1010A-AP | SIL-10X10-FLEX-PROFILE/M |

LED PROFILES



| Code | UPRO-3.1M | UPRO-CWC | UPRO-CWF | UPRO-CFC | UPRO-CFF | UPRO-EC |
|-------------|-------------|--------------------------|----------------------------|---------------------|-----------------------|---------------------------------------|
| Description | "U" profile | Cover with wings - clear | Cover with wings - frosted | Flush cover - clear | Flush cover - frosted | Endcap for Profile with strain relief |
| Supplied as | 3.1m Length | 3.1m Length | 3.1m Length | 3.1m Length | 2.5m Length | - |
| Material | Aluminium | PMMA | PMMA | PMMA | PMMA | - |

Commercial

Profile and covers to be ordered separately.
 Monza and Nizza Profiles below and also **MZA** profiles above can be mounted using the "U" Profile



| Code | MZAPRO-2M | NIZPRO-3.1M | LINEPRO-2M | MONPRO-3.1M | CANPRO-2M |
|---------------------|--------------------------------|--------------------------------|-------------------------------------|---------------------------------|---------------------------------|
| Description | Monza Profile - For 8mm strips | Nizza Profile - For 8mm strips | Half Round Profile - For 8mm strips | Monaco Profile - For 4mm strips | Cannes Profile - For 8mm strips |
| Size H x W x L (mm) | 14 x 11 x 2000 | 12 x 11 x 3100 | 20 x 12 x 2000 | 5 x 7 x 3100 | 10 x 10 x 2500 |
| Mounting Clips | MZAPRO-CL | NIZPRO-CL | - | MONPRO-CL | CANPRO-CL |
| End Caps | MZAPRO-EC | NIZPRO-EC | - | MONPRO-EC | CANPRO-EC |
| Material | PMMA | PMMA | PMMA | PMMA | PMMA |

LIGHTING

Does not c/w LED Strip
 LED Strip to be Ordered Separately

LED PROFILES

LED Recessed Aluminium Profile

Supplied without LED Strip - to be Ordered Separately

End Caps and Mounting clips to be ordered separately

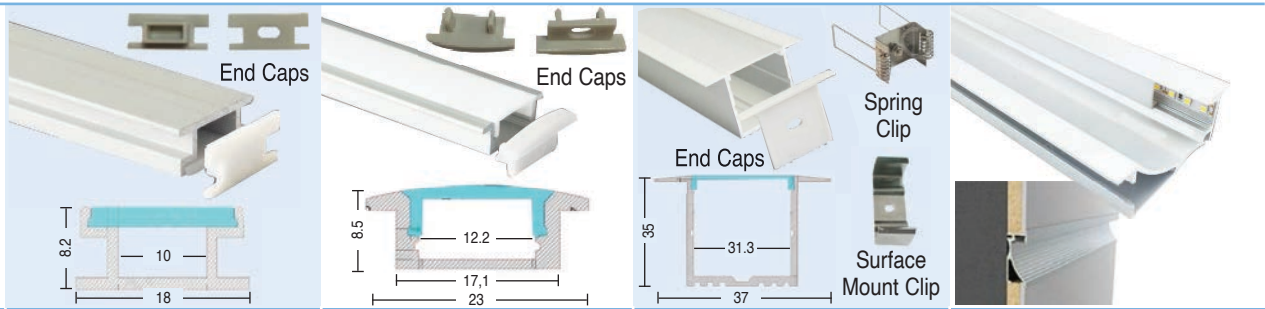

| Code | PFFLL01 | PFRLS05 | HL-BAPL017 | HL-BAPL023 |
|----------------|------------|------------|---------------|---------------|
| Length | 2m | 2.5m | 2m | 2m |
| Mounting Clips | - | - | HL-BAPL017-CL | - |
| Spring Clips | - | - | HL-BAPL017-SC | - |
| End Caps | PFFLL01-EC | PFRLS05-EC | HL-BAPL017-EC | HL-BAPL023-EC |

LED Surface Aluminium Profile

Supplied without LED Strip - to be Ordered Separately

End Caps and Mounting clips to be ordered separately

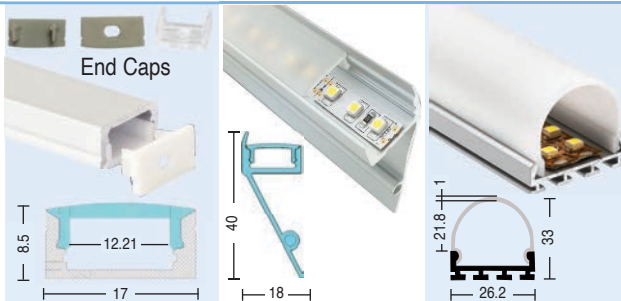

| Code | PFRLS06 | HL-BAPL030 | LUXX-3R |
|----------------|------------|---------------|------------|
| Length | 2.5m | 2m | 2m |
| Mounting Clips | PFRLS06-CL | HL-BAPL030-CL | LUXX-3R-CL |
| End Caps | PFRLS06-EC | HL-BAPL030-EC | LUXX-3R-EC |

LED Stairs Aluminium Profile

Size: 80 x 42mm l c/w Treads

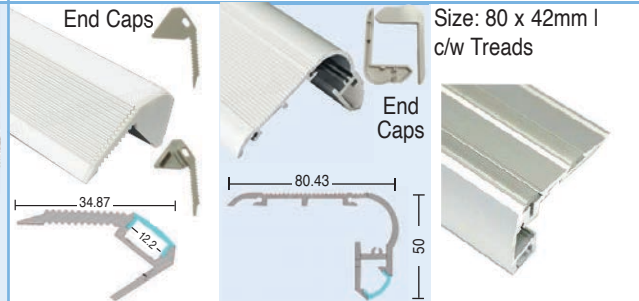

| Code | HL-BAPL022 | HL-BAPL047 | PFSTR01 |
|----------------|---------------|---------------|------------|
| Length | 2.5m | 2.5m | 2m |
| Mounting Clips | - | - | PFSTR01-CL |
| End Caps | HL-BAPL022-EC | HL-BAPL047-EC | PFSTR01-EC |

LED 90° Aluminium Profile

Supplied without LED Strip - to be Ordered Separately

End Caps and Mounting clips to be ordered separately

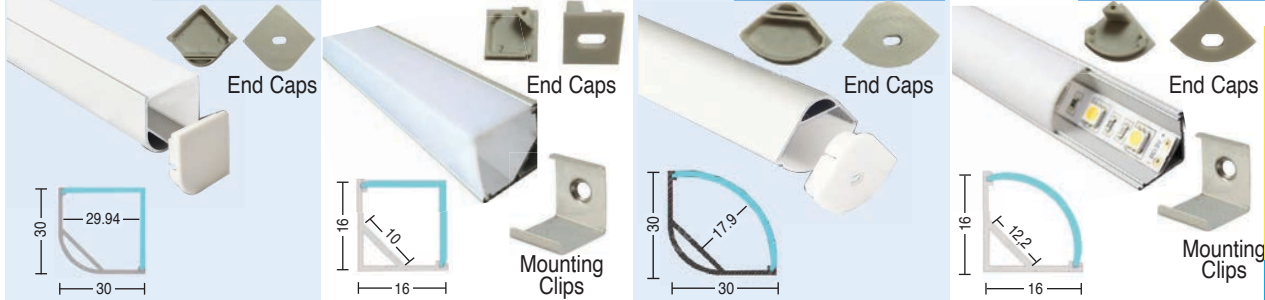

| Code | HL-BAPL015 | PFSC01 | HL-BAPL016 | PFSC02 |
|----------------|-----------------|-----------|-----------------|-----------|
| Length | 2.5m | 2m | 2.5m | 2.5m |
| Mounting Clips | HL-BAPL015/6-CL | PFSC01-CL | HL-BAPL015/6-CL | PFSC02-CL |
| End Caps | HL-BAPL015-EC | PFSC01-EC | HL-BAPL016-EC | PFSC02-EC |

LED Glass Aluminium Profile

Supplied without LED Strip - to be Ordered Separately
End Caps and Mounting clips to be ordered separately



| Code | HL-BAPL044C |
|----------------|----------------|
| Length | 2m |
| Mounting Clips | - |
| End Caps | HL-BAPL044C-EC |

Wardrobe Aluminium Profile



| Code | HS-LEDAP37 |
|----------------|-----------------------------------|
| Length | 3m |
| Mounting Clips | HS-LEDAP37-MC01 / HS-LEDAP37-MC02 |
| End Caps | HS-LEDAP37-EC |

PROFILES

Plaster Construction Aluminium Profile

| | | | |
|-----------------|------------------------|------------------------|------------------------|
| | | | |
| Code | HS-LEDAP3303 | HS-LEDAP3302 | HS-LEDAP3301 |
| Length | 3m | 3m | 3m |
| End Caps | HS-LEDAP3303-EC | HS-LEDAP3302-EC | HS-LEDAP3301-EC |
| | | | |
| Code | HS-LEDAP3304 | HS-LEDAP1201 | HS-LEDAP3305 |
| Length | 3m | 3m | 3m |
| End Caps | HS-LEDAP3304-EC | HS-LEDAP1201-EC | HS-LEDAP1202-EC |

Supplied without LED Strip - to be Ordered Separately | End Caps to be Ordered Separately

LED PROFILES C/W LEDS

Single Colour or Colour Changing

Supply voltage: 12VDC
Supplied c/w required mounting accessories
Maximum length connected in series: 2000mmØ

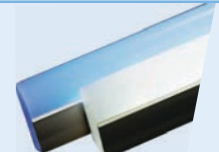
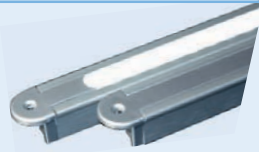

| | | | |
|-----------------------------|-----------------------------------------|-----------------------------------------|-----------------------------------------|
| Code | VIS5*-A* | MZA*-A* | IMO2*-A* |
| Size H x W (mm) | 15 x 18 | 14 x 11 | 20 x 12 |
| *Specify Length (mm) | 255 (2.5W) 505 (4.5W) 1005 (9.0W) | 272 (2.5W) 522 (4.5W) 1022 (9.0W) | 260 (2.5W) 510 (4.5W) 1010 (9.0W) |
| Connection | Wire | Wire | Wire |
| Material | Aluminium | PMMA | PMMA |

Single Colour or Colour Changing

Supply voltage: 12VDC
Supplied c/w required mounting accessories
Maximum length connected in series: 2000mmØ

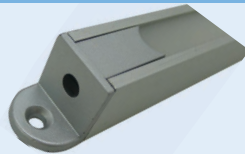

| | | | |
|-----------------------------|-----------------------------------------|-----------------------------------------|-----------------------------------------|
| Code | VIS6*-A* | MON2*-A* | CAN*-A* |
| Size H x W (mm) | 15 x 14 | 5 x 7 | 10 x 10 |
| *Specify Length (mm) | 250 (2.5W) 500 (4.5W) 1000 (9.0W) | 266 (2.5W) 516 (4.5W) 1016 (9.0W) | 270 (2.5W) 520 (4.5W) 1020 (9.0W) |
| Connection | Jack | Wire | Wire |
| Material | Aluminium | PMMA | PMMA |

*Specify Colour: ○ CW (Cool White), ○ WW (Warm White), ●●● RGB (Colour Changing). For Power Supplies and RGB controllers please see page 93

LED SHELF TAG



Standard Strips - Input Voltage: 24VDC | LED Chip: 3020 | CRI > 80 |

Colour Temperature: 5500K | Beam Angle: 180° Front Side Up, 120° Back Side Down

| | | | |
|--------------------|----------------|---------------|------------------|
| Code | Wattage | Lumens | Size |
| LST-1185-PW | 11W | 935lm | 1000 x 48.6 x 12 |

With Butcher Strip - Input Voltage: 24VDC | LED Chip: 3020 | CRI > 80 |

Colour Temperature: 5500K | Beam Angle: 180° Front Side Up, 120° Back Side Down

| | | | |
|-----------------------|-----|-------|------------------|
| LST-1185-PW-BL | 11W | 935lm | 1000 x 48.6 x 12 |
|-----------------------|-----|-------|------------------|

SIDE VIEW LED STRIP LIGHTS IP20

SMD Side View Non-Weatherproof - 12VDC

- LED Type SMD335
- With self-adhesive backing

- Cutting length every 3rd LED
- Max pcs connected on same supply 2 x 5m



| Code | No. of LEDs/m | Max Power | Lumen/m | LED Spacing | Length |
|---------------|---------------|-----------|---------------------------------------|-------------|--------|
| SV60W-R335-* | 60/m | 4.8W/m | R:70 Y:80 G:120 B:60 CW:180 WW:180 | 16.7mm | 5m |
| SV120W-R335-* | 120/m | 9.6W/m | R:140 Y:160 G:240 B:120 CW:360 WW:360 | 8.3mm | 5m |

*Add colour to code: ●R (Red), ●GN (Green), ●Y (Yellow), ●BL (Blue), ○CW (4000k), ○WW (3200k)

SIDE VIEW LED STRIP LIGHTS IP54

SMD Side View Weatherproof - 12VDC

- LED Type SMD335
- With self-adhesive backing

- Cutting length every 3rd LED
- Max pcs connected on same supply 2 x 5m



| Code | No. of LEDs/m | Max Power | Lumen/m | LED Spacing | Length | PCB colour |
|---------------|---------------|-----------|---------------------------------------|-------------|--------|------------|
| SV60W-W335-* | 60/m | 4.8W/m | R:70 Y:80 G:120 B:60 CW:180 WW:180 | 16.7mm | 5m | White |
| SV120W-W335-* | 120/m | 9.6W/m | R:140 Y:160 G:240 B:120 CW:360 WW:360 | 8.3mm | 5m | White |

*Add colour to code: ●R (Red), ●GN (Green), ●Y (Yellow), ●BL (Blue), ○CW (4000k), ○WW (3200k)

ZIG-ZAG LED FLEXIBLE STRIP 12VDC IP20

Foldable & bendable shaping | LED type SMD 2835 | With self-adhesive tape |
Cutting length every 3rd LED



| Code | Max Power | Lumens | No. of LEDs | Length |
|-----------------------|-----------|-----------|-------------|--------|
| ZZ60W-R2835-* | 6.0W/m | 480-660lm | 60/m | 5m |
| ZZ48W-R5050-RGBW ●●●○ | 15.38W/m | - | 48/m | 5m |

*Add colour to code: ○WW (Warm White - 3000K), ○DL (Daylight - 5000K), ●R (Red), ●G (Green), ●B (Blue)

STRIP LIGHT CONNECTORS

Accessories for Non-Weatherproof SMD Strips

| Code | Description | Pack Size |
|---------------|--------------------------------------------------|-----------|
| IMG-LJQ/10 | 2-Wire double sided connector for IMG-R30 strips | 10 |
| IMG-JXQ/10 | 2-Wire single-sided connector for IMG-R30 strips | 10 |
| IMG-ACC2-2/10 | 2-Wire white connector | 10 |
| SP2104 | 12V Male plug | 1 |
| SP2105 | 12V Female plug | 1 |
| IMG-ACC4-1 | 4-Wire connector for RGB strips | 1 |
| SL-CON16 | DC female connector with 2 male connectors | 1 |

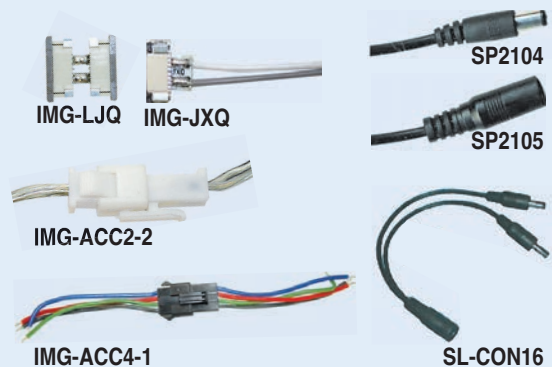

Accessories for Weatherproof SMD Strips

| Code | Description | Pack Size |
|----------------|------------------------------------------------------------|-----------|
| SP104F | 4 Wire 12V Male Plug | 1 |
| SP105F | 4 Wire 12V Female Plug | 1 |
| IMG-ACC2-1F/5 | Mini waterproof 2-wire connector IP65 | 5 |
| IMG-ACEP2-F/10 | Weatherproof end cap | 10 |
| IMG-ACHH-1/10 | Flat transparent Mounting Clip for weatherproof LED strips | 10 |
| SL-CON11 | 2-Wire waterproof connector | 1 |



Wiring Diagram for use of RGB Amplifier

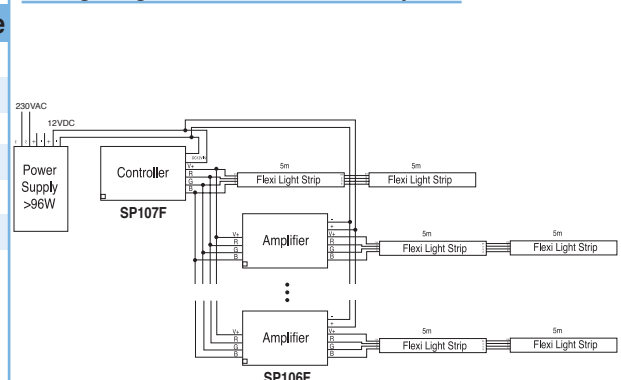

RIGID LED STRIP LIGHTS

IP65

 Supply Volts 24VDC
 Aluminium Housing

| Size | 100mm | | | 600mm | | | 900mm | | |
|----------|---------|-------|--------|---------|-------|--------|---------|-------|--------|
| Colour | Code | Watts | Lumens | Code | Watts | Lumens | Code | Watts | Lumens |
| ● Red | LEDS1-R | 0.48W | 36lm | LEDS2-R | 2.88W | 216lm | LEDS3-R | 4.32W | 324lm |
| ● Green | LEDS1-G | 0.48W | 36lm | LEDS2-G | 2.88W | 216lm | LEDS3-G | 4.32W | 324lm |
| ● Yellow | LEDS1-Y | 0.48W | 36lm | LEDS2-Y | 2.88W | 216lm | LEDS3-Y | 4.32W | 324lm |
| ● Blue | LEDS1-B | 0.48W | 36lm | LEDS2-B | 2.88W | 216lm | LEDS3-B | 4.32W | 324lm |
| ○ White | LEDS1-W | 0.48W | 36lm | - | 2.88W | 216lm | LEDS3-W | 4.32W | 324lm |

SMD Bars Non-Weatherproof - open type Rigid P.C.B I Supply Volts 12VDC | LED Type 3528

| Size | 500 x 8mm | | | |
|-------------|--------------|------|---------------|-------------|
| Code | Colour | LEDs | Lumen per LED | Total Watts |
| IMG-B30R-S | ● Red | 30 | 2 | 1.2W |
| IMG-B30G-S | ● Green | 30 | 3.6 | 1.2W |
| IMG-B30Y-S | ● Yellow | 30 | 2 | 1.2W |
| IMG-B30B-S | ● Blue | 30 | 1.7 | 1.2W |
| IMG-B30PW-S | ○ Pure White | 30 | 4.4 | 1.2W |
| IMG-B30WW-S | ○ Warm White | 30 | 4.4 | 1.2W |

Weatherproof SMD Bars IP65 - Aluminium Housing | Supply Volts 12VDC | LED Type 3528 | With adhesive tape on back

| Size | 510 x 10mm | | | |
|--------------|--------------|------|---------------|-------------|
| Code | Colour | LEDs | Lumen per LED | Total Watts |
| IMG-B30R-SF | ● Red | 30 | 2 | 1.2W |
| IMG-B30G-SF | ● Green | 30 | 3.6 | 1.2W |
| IMG-B30Y-SF | ● Yellow | 30 | 2 | 1.2W |
| IMG-B30B-SF | ● Blue | 30 | 1.7 | 1.2W |
| IMG-B30PW-SF | ○ Pure White | 30 | 4.4 | 1.2W |
| IMG-B30WW-SF | ○ Warm White | 30 | 4.4 | 1.2W |

IMG-ACHH-2 **IMG-ACC2-1F** **IMG-ACEP2-F**

| Accessories | |
|----------------|-------------------------------------|
| IMG-ACHH-2/10 | Mounting clip/ 10 |
| IMG-ACC2-1F/5 | Mini waterproof 2-wire connector/ 5 |
| IMG-ACEP2-F/10 | Mini waterproof end-cap/ 10 |

Tri-Chip (High Intensity Pure White) - open type Rigid P.C.B I Supply Volts 12VDC | LED Type 5050 | Non-weatherproof

| Size | 500 x 11.7mm | | |
|--------------|--------------|---------------|-------------|
| Code | LEDs | Lumen per LED | Total Watts |
| IMG-B15CW-3S | 15 | 17 | 3.6W |

Accessories - per pack of 10

| Code | Description |
|---------------|------------------------------|
| IMG-ACHH-4/10 | Mounting Clip for IMG-B30X-S |
| IMG-ACC2-2/10 | 2-wire white connector |
| IMG-ACHH-5/10 | Mounting clip for IMG-B15-3S |

Slim Type SMD Bar Pure White - open type Rigid P.C.B I Supply Volts 12VDC | LED Type 3528 | Non weatherproof

| Size | 500 x 4 x 3.5mm | | |
|----------------|-----------------|---------------|-------------|
| Code | LEDs | Lumen per LED | Total Watts |
| SABL-45S3528-W | 45 | 4.4 | 7.2W |

Slim Type SMD Bar - open type Rigid P.C.B I Supply Volts 12VDC | LED Type 3020 | Non-weatherproof

| Size | 300 x 4 x 3mm | | | |
|---------------|---------------|------|---------------|-------------|
| Code | Colour | LEDs | Lumen per LED | Total Watts |
| SBL-24S3020-R | ● Red | 24 | 1.26 | 1.44W |
| SBL-24S3020-Y | ● Yellow | 24 | 1.26 | 1.44W |
| SBL-24S3020-B | ● Blue | 24 | 0.47 | 1.44W |
| SBL-24S3020-G | ● Green | 24 | 2.2 | 1.44W |
| SBL-24S3020-W | ○ White | 24 | 4.4 | 1.44W |

LED Noble Light IP65 - Aluminium Housing | Linkable | Supply voltage 12 VDC | LED Type 5050 | Size: 17.4W x 11.4Hmm | 50 000hrs life time | Can be directly connected to each other or via a connection cable | For power supply and RGB controller see page 93.

Accessories (included in pack)

| Code | Colour | LEDs | Lumen | Length | Power | Max units in series |
|----------|--------------|------|-------|--------|-------|---------------------|
| NL24-WW | ○ Warm White | 24 | 252lm | 500mm | 4.5W | 10 |
| NL24-PW | ○ Pure White | 24 | 312lm | 500mm | 4.5W | 10 |
| NL24-RGB | ● ● ● RGB | 24 | 220lm | 500mm | 4.5W | 10 |
| NL48-WW | ○ Warm White | 48 | 576lm | 1000mm | 9W | 5 |
| NL48-PW | ○ Pure White | 48 | 624lm | 1000mm | 9W | 5 |
| NL48-RGB | ● ● ● RGB | 48 | 440lm | 1000mm | 9W | 5 |

LED FLEX STRIP KITS

Supply Voltage: 100-240VAC
Kit complete with transformer and ON/OFF Switch
Blister Packed



| Code | LS1739-* | LS1732-* | LS1732H-* | LS1756K-RGB |
|-----------|-------------------------|-----------------------|-----------------------|------------------------|
| Size (mm) | 460(L) x 17.5(W) x 3(H) | 307(L) x 10(W) x 3(H) | 307(L) x 10(W) x 3(H) | 2000(L) x 14(W) x 4(H) |
| Lumen | 280lm | 80lm | 80lm | 9lm/ LED |
| LEDs | 6 | 12 x 2 | 12 x 3 | 60 |
| IP Rating | IP65 | IP44 | IP44 | IP44 |

*Add colour to code: ○ CW (Cool White), ○ WW (Warm White)

LED RIGID STRIP KITS

LED Strip Kits - Rigid P.C.B.

Supply Voltage: 100-240VAC
Kit complete with transformer and ON/OFF Switch.
Blister Packed



| Code | LS1769-1-* | LS1769-4-* | LS1779-30-* | LS1779-50-* |
|-----------|-------------------|-----------------|---------------------|---------------------|
| Size (mm) | 300L x 12W x 8.5H | 300L x 12W x 8H | 311.5L x 10.5W x 4H | 511.5L x 10.5W x 4H |
| Lumen | 180lm | 100lm | 120lm x 2 | 200lm |
| LEDs | 27 | 15 x 4 | 10 x 2 | 30 |
| IP Rating | IP44 | IP44 | IP65 | IP65 |

* Add colour to code: ○ CW (Cool White), ○ WW (Warm White), ● R (Red), ● BL (Blue), ● GN (Green), ● Y (Yellow)

Supply Voltage: 100-240VAC
Kit complete with transformer and ON/OFF Switch
Blister Packed

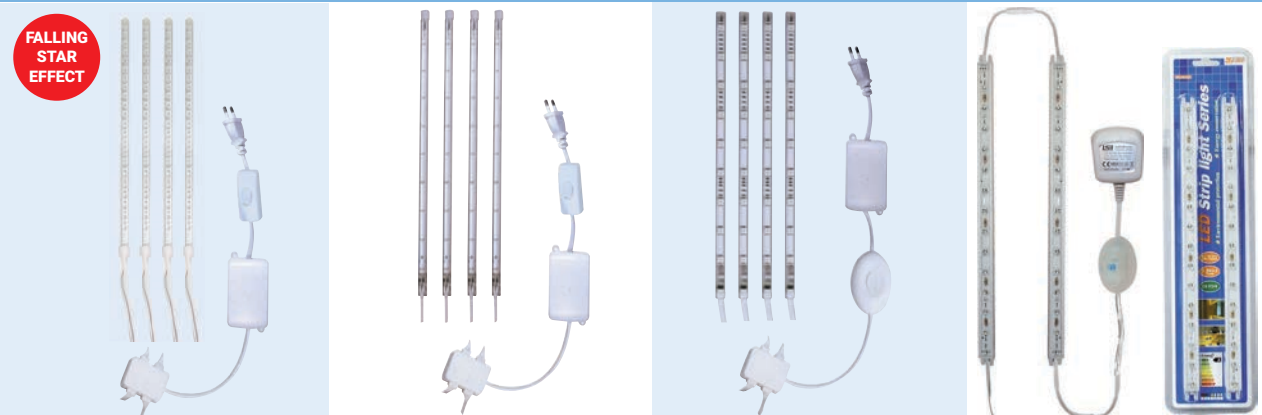

| Code | LS1105-CW | EL206763-K-RGB | EL206764-K-* | LS1731-* |
|-----------|-----------------|------------------|------------------|--------------------|
| Size (mm) | 400L x 150 | 260L x 9.5W x 7H | 272L x 8.6W x 6H | 305L x 15W x 13.5H |
| Lumen | 35lm | - | - | 105lm x 2 |
| LEDs | 44 x 5 | 9 x 4 | 9 x 4 | 15 x 2 |
| IP Rating | IP65 | IP20 | IP20 | IP44 |
| Colour | Cool White only | RGB only | | |

*Add colour to code: ○ DL (Daylight), ○ WW (Warm White)

LED STRIP LIGHTING

Piranha

Supply Voltage:
c/w transformer
230/12VDC

- Open PC Housing
- With self-adhesive backing



- PC Housing
- With self-adhesive backing

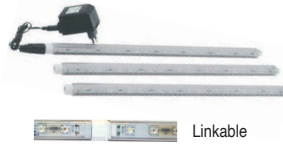

- PC Housing
- With self-adhesive backing
- c/w mounting clips



- PC Housing
- With self-adhesive backing
- c/w mounting clips



| Code | HLI00702-* | HLI00802-* | HLI00601-* | HLI00601-* |
|--------------|--------------------|--------------------|----------------------|----------------------|
| Size | 426L x 13W x 14Dmm | 450L x 17W x 17Dmm | 1000L x 22W x 22Dmm | 300L x 22W x 22Dmm |
| LEDs | 21 x 0.08W (1.6W) | 21 x 0.08W (1.6W) | 70 x 0.06W (4.2W) | 42 x 0.06W (.52W) |
| IP Rating | IP20 | IP20 | IP65 | IP65 |
| Lumen | 60 | 60 | 210 | 113 |
| Kit includes | 3Pcs + Transformer | 3Pcs + Transformer | 230VAC direct supply | 230VAC direct supply |

* Add colour to code: ○ **CW** (Cool White), ○ **WW** (Warm White), ● **R** (Red), ● **BL** (Blue), ● **GN** (Green), ● **Y** (Yellow)

EDGE LIT LIGHT BOX HIGH POWER LED'S

Designed for use
in double sided
light box
160-400mm
deep
Colour Temp:
6000K

Non-Weather Proof - 24VDC

Weather Proof IP65 - 24VDC

IP65 - 12VDC

Max 15 Modules in Series

| Code | Z6003XBD-DL | Z6005XBD-DL | Z7003XBD-DL | Z7005XBD-DL | Z19-12-1 |
|--------------|-----------------|-----------------|-----------------|-----------------|----------------|
| Power | 6.8W | 11W | 6.8W | 11W | 3W |
| Lumen | 660lm | 1100lm | 660lm | 1100lm | 280lm |
| No. of LED's | 3 | 5 | 3 | 5 | 1 |
| Size | 298 x 28 x 16mm | 518 x 28 x 16mm | 323 x 30 x 22mm | 543 x 30 x 22mm | 66 x 42 x 14mm |

BACK LIT LIGHT BOX HIGH POWER LED'S

- Back Lighting
- Applied to 5-10cm deep lighting box
- 175° View angle
- Samsung LED equipped
- Constant current, Aluminium PCB

**Back Lit - 24VDC
6500K**

- 160° View angle
- Samsung LED equipped
- Constant current
- Min cutting length every 3 modules

**Back Lit - 24VDC
6500K**

| Code | YD7-3.0-2403 | YD7-3.0-4806 | YD7-3.0-9612 | Code | AL-3300-24-3 |
|--------------|--------------|--------------|--------------|--------------|---------------|
| Power | 3.6W | 7.2W | 14.4W | Power | 4.8W/ 3 LED's |
| Lumen | 357lm | 708lm | 1375lm | Lumen | 390lm |
| No. of LED's | 3 | 6 | 12 | No. of LED's | 30 |
| Size | 240 x 20mm | 480 x 20mm | 960 x 20mm | Length | 5.250 meters |

LED SIGNAGE BACK LIGHTING

5 Year
Warranty**ST2 Premium Range - IP65** Supply Voltage 12VDC | Epistar SMD 2835 | Over Moulded | 160° View Angle

| Code | Power/PC | Lumen/PC | Max Qty/Series | Dimensions (mm) | Spacing between modules | Length for 10 modules |
|---------------|----------|----------|----------------|-----------------|-------------------------|-----------------------|
| BV-ST2-2-** | 0.72W | 44lm | 30 Pcs | 52 x 14 x 5.5 | 100mm | ± 1620mm |
| BV-ST2-3-**-* | 0.72W | 66lm | 30 Pcs | 75.4 x 14 x 5.5 | 120mm | ± 2074mm |

*Add Colour to code: ○DL (Daylight 6500K), ●Y (Yellow), ●R (Red), ●G (Green), ●BL (Blue)

*Add Number of Modules to code: /10 (10 Pcs), /30 (30 Pcs)

4 Year
Warranty**ST6 Premium Range - IP65** Supply Voltage 12VDC | Epistar SMD 5730 High Lumen Performance | over moulded | 160° View Angle

| Code | Power/PC | Lumen/PC | Max Qty/Series | Dimensions (mm) | Spacing between modules | Length for 10 modules |
|-------------|----------|-----------|----------------|-------------------|-------------------------|-----------------------|
| BV-ST6-2-** | 1.44W | 80-90lm | 30 Pcs | 57.4 x 16.3 x 6.2 | 100mm | ± 1674mm |
| BV-ST6-3-** | 1.44W | 120-135lm | 30 Pcs | 83 x 16.3 x 6.2 | 120mm | ± 2150mm |

*Add Colour to code: ○DL (Daylight 6500K), ●R (Red), ●G (Green), ●BL (Blue)

*Add Number of Modules to code: /10 (10 Pcs), /30 (30 Pcs)

5 Year
Warranty

NEW

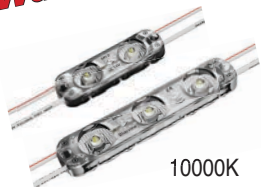
10000K
Module**M6 Range - IP65** Supply Voltage 12VDC | High quality 2835 chipset | High lumen efficacy 100lm/W | Constant current design to provide uniform lighting throughout | Single module cuttable | 175° Beam Angle

| Code | Power/PC | Lumen/PC | Max Qty/Series | Dimensions (mm) | Spacing between modules | Length for 10 modules |
|--------------|----------|----------|----------------|-----------------|-------------------------|-----------------------|
| BV-M6-2-**-* | 0.72W | 72lm | 50 Pcs | 49 x 15 x 7.7 | 101.5mm | ± 1505mm |
| BV-M6-3-**-* | 1.1W | 110lm | 40 Pcs | 70 x 15 x 7.7 | 115mm | ± 1850mm |

*Add Colour to code: ○DL (Daylight 6500K), ○SW (Sky White 10000K), ●R (Red), ●GN (Green), ●BL (Blue)

*Add Number of Modules to code: 10 (10 Pcs), 30 (30 Pcs)

2 Year
Warranty**PJ2 Economy Range - IP67** Constant Voltage 12VDC | SMD 2835 | Colour Temp: 6500K | 120° View Angle

| Code | Power/PC | Lumen/PC | Max Qty/Series | Dimensions (mm) | Spacing between modules | Length for 10 modules |
|-----------|----------|----------|----------------|------------------|-------------------------|-----------------------|
| BV-PJ2-1* | 0.096W | 10lm | 20 Pcs | 14.2 x 8.4 x 5.3 | 40mm | ± 582mm |
| BV-PJ2-2* | 0.192W | 20lm | 20 Pcs | 25.2 x 8.4 x 5.3 | 40mm | ± 692mm |
| BV-PJ2-3* | 0.288W | 30lm | 20 Pcs | 54.2 x 8.4 x 5.3 | 60mm | ± 1202mm |

*Add Number of Modules to code: /10 (10 Pcs), /30 (30 Pcs)

3 Year
Warranty**High Light Efficiency 3-in-1 RGB - IP67** Constant Voltage 12VDC | Epistar 3 in 1 SMD 5050 | Synchronized colour changing driven by LED Controller | 120° View Angle

| Code | Power/PC | Lumen/PC | Max Qty/Series | Dimensions (mm) | Spacing between modules | Length for 10 modules |
|-------------|----------|----------|----------------|-----------------|-------------------------|-----------------------|
| BV-SMD-RGB* | 0.72W | - | 30 Pcs | 70.6 x 12 x 6.8 | 82mm | ± 1608mm |

*Add Number of Modules to code: /10 (10 Pcs), /30 (30 Pcs)

5 Year
Warranty**SG2 High Output Premium Range - IP65** Constant Voltage 12VDC | SMD 2835 | Over Moulded | Colour Temp: 6500K | 160° View Angle

| Code | Power/PC | Lumen/PC | Max Qty/Series | Dimensions (mm) | Spacing between modules | Length for 10 modules |
|-------------|----------|----------|----------------|-----------------|-------------------------|-----------------------|
| BV-SG2-144* | 1.44W | 230lm | 20 Pcs | 48 x 44.3 x 4 | 120mm | ± 1800mm |

*Add Number of Modules to code: /10 (10 Pcs), /30 (30 Pcs)

INDUSTRIAL / COMMERCIAL ZIGBEE SYSTEM

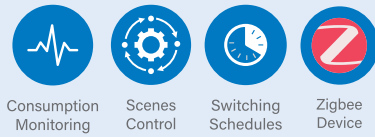

Zigbee Gateway - Ethernet Interface | Ma 200 Devices max. in One Gateway | Area Setting: 20 max | Group Setting: 30 max | Bind Setting with Sensor, Switches and Remote Control | Scene and Timer Settings | 1 Admin Account + 10 Sub Accounts.

| | |
|-------------|---------------------|
| Code | AHGW928-Z-IA |
|-------------|---------------------|

| | |
|--------------------|-------------------|
| Input Voltage | 5VDC |
| Wireless Frequency | 2.4GHz |
| Size | 127.5 x 80 x 30mm |

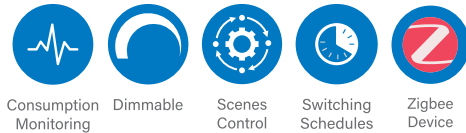

Zigbee 1-10V Dimming LED Controller IP65 - Works with 1-10V Dimmable Driver | Zigbee Wireless Control: Smart Phone, Tablet, PC, Wall Switch, Remote Control | Works with Zigbee Gateway for Sensors, Area, Timer, Scene and Group Control | Power Metering | 3 in 1 Version: Basic / Motion Binding / Motion Daylight

| | |
|-------------|--------------------|
| Code | AHLC734-WPC |
|-------------|--------------------|

| | |
|-----------------------|-----------------|
| Input Voltage | 100 - 277VAC |
| Output Voltage | 1-10V / 0-10V |
| 1-10V Current | 15mA |
| Wireless Frequency | 2.4GHz |
| Transmission Distance | 30m |
| Size | 195 x 50 x 50mm |



Zigbee Microwave Motion Sensors IP65 - 3 Step Dimming Control | c/w Mounting Bracket | Wall Mount or Ceiling Mount | Heat Map Sensor Option Audible

| | |
|-------------|--------------------|
| Code | AHMS823-Z-* |
|-------------|--------------------|

| | |
|--------------------|--------------------------------|
| Input Voltage | 100 - 277VAC |
| Wireless Frequency | 2.4GHz |
| Detection Range | Ø30m @ 15m |
| Mounting Height | 15m Max |
| Detection Angle | 30° - 150° |
| Size | Ø55.2 x 24.5 (Without Bracket) |

* Add to Code: **CMS** (Ceiling Mounted Sensor), **WMS** (Wall Mount Sensor)

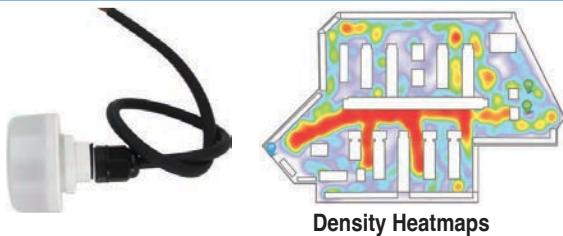

Density Heatmaps

Zigbee Heatmap Sensor IP65 - 3 Step Dimming Control | c/w Mounting Bracket

| | |
|-------------|---------------------|
| Code | AHMS823-Z-HM |
|-------------|---------------------|

| | |
|--------------------|-------------------------------|
| Input Voltage | 100-277VAC |
| Wireless Frequency | 2.4GHz |
| Detection Range | 0-65528lux |
| Resolution | 10lux |
| Size | 55.2 x 24.5 (Without Bracket) |



Zigbee Daylight Sensor IP65 - Automatic Illuminance Control on Indoor Lighting Based on Ambient Light | Set Constant Illuminance Value on App

| | |
|-------------|---------------------|
| Code | AHDS826-Z-DS |
|-------------|---------------------|

| | |
|--------------------|-------------------------------|
| Input Voltage | 100-277VAC |
| Wireless Frequency | 2.4GHz |
| Detection Range | 0-65528lux |
| Resolution | 10lux |
| Size | 55.2 x 24.5 (Without Bracket) |

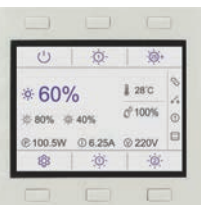

Zigbee Multi-functional Wall Switch - used to manually control lights

| | |
|-------------|-----------------------|
| Code | AHWS-933-Z-MWS |
|-------------|-----------------------|

| | |
|-----------------------|-------------------|
| Input Voltage | 200-240VAC |
| Output | 3A - relay output |
| Wireless frequency | 2.4GHz |
| Transmission distance | 30m |
| Size | 86 x 86 x 35mm |



The PC software/ mobile App works with smart lighting system for Area control, Group settings, Scene control, Schedule control, Account management, Lamp power metering function, Lamps fail report function, OTA function and all devices that follow Zigbee HA1.2 protocol through WiFi - Zigbee Gateway

• Linux/Windows PC software by special request (with a price)

AH-SERVER-I



LED FLOOR & WALL LIGHTS

| | | | |
|--------------------------------------------------------------|--------------------------------------------------------------------------------------------------|---------------------------------------------------------------------------------------------------|----------------------------------------------------------------------------------------------------|
| Supply Voltage: 230VAC | 3 light kit  | 3 light kit  | 3 light kit  |
| Kits c/w 230VAC Transformer and 3-in-1 connector | | | |
| Code | CIE-L001-* | CIE-L002-* | LED-HH03/3-* |
| Size (mm) | 95 x 95 x 125 | Ø95 x 125 | Ø59 x 50 |
| LED's/Light | 4 x 0.15W (0.6W) | 6 x 0.1W (0.6W) | 5 x 0.1W (0.5W) |
| IP Rating | IP44 | IP44 | IP65 |
| Lumen/Lamp | 13 | 13 | 9 |
| Material | Stainless Steel | Stainless Steel | Aluminium |



*Add colour to code: ○ **CW** (Cool White), ○ **WW** (Warm White), ● **BL** (Blue), ● **Y** (Yellow), ● **GN** (Green), ● **R** (Red)

| | | | |
|--------------------------------------------------------------|--------------------------------------------------------------------------------------------------|-------------------------------------------------------------------------------------------------------------------------------------------------------|----------------------------------------------------------------------------------------------------|
| Supply Voltage: 230VAC | 3 light kit  | 5 light kit (35mm Ø cutout) For 5 light kit 10VA Transformer  | 3 light kit  |
| Kits c/w 230VAC Transformer and 3-in-1 connector | | | |
| Code | HLF01702-* | LED-P03C/5-* Kit | HLG01201-* Single light |
| Size (mm) | Ø30 x 15 | Ø40 x 57 | 73 x 73 x 18 |
| LED's/Light | 1W | 6 x 0.08W (0.5W) | 12 x 0.04W (0.5W) |
| IP Rating | IP20 | IP65 | IP20 |
| Lumen/Lamp | 138 | 15 | 38 |
| Material | Plastic / Clear PC | Aluminium / Clear Glass | Nickel / Matt Glass |

*Add colour to code:
○ **CW** (Cool White), ● **BL** (Blue)

*Add colour to code: ○ **CW** (Cool White), ○ **WW** (Warm White), ● **BL** (Blue), ● **Y** (Yellow), ● **GN** (Green), ● **R** (Red)

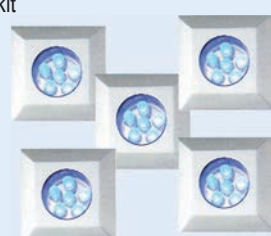
***CW, WW & BL** available

| | | | |
|--------------------------------------------------------------|----------------------------------------------------------------------------------------------------|-----------------------------------------------------------------------------------------------------|------------------------------------------------------------------------------------------------------|
| Supply Voltage: 230VAC | 5 light kit  | 3 light kit  | 3 light kit  |
| Kits c/w 230VAC Transformer and 3-in-1 connector | | | |
| Code | HLG01402-* | HLG01604-* | HLG02102-* |
| Size (mm) | 40 x 40 x 44 | 59 x 59 x 50 | Ø55 x 8 |
| LED's/Light | 6 x 0.08W (0.5W) | 5 x 0.1W (0.5W) | 3 x 0.5W (1.5W) |
| IP Rating | IP65 | IP65 | IP65 |
| Lumen/Lamp | 15 | 9 | 46 |
| Material | Aluminium | Aluminium | Aluminium |

*Add colour to code: ○ **CW** (Cool White), ○ **WW** (Warm White), ● **BL** (Blue), ● **Y** (Yellow), ● **GN** (Green), ● **R** (Red)

Accessories



Outdoor Transformers IP68



| | | | | | |
|-------------|---------------------------------|---------------------------------|-------------------|--------------------|--------------------|
| Code | 3-IN-1 | 6-IN-1 | TRF24/6 | TRF24/20 | TRF24/30 |
| Description | Spare 3 in 1 connector for kits | Spare 6 in 1 connector for kits | 230V/24VAC 6VA | 230V/24VAC 20VA | 230V/24VAC 30VA |

LED DECK LIGHTS

Supply Volts: **IP67** Single Light
12VDC
Low Profile:
9mm



IP67



6 Pcs Kit comes with T-Cable, Power Supply, Controller (RGB)



| Code | SC-B101B-* | SC-B101C | SC-B102B-* | SC-B102C | SC-6B101B-CW | SC-6B101C-RGB | SC-6B102B-CW | SC-6B102C-RGB |
|--------------|-------------------------|----------|-------------|----------|-------------------------|---------------|--------------|---------------|
| Power | 0.5W | 0.7W | 0.6W | 0.9W | 0.5W | 0.7W | 0.6W | 0.9W |
| No. of LEDs | 1pc | | | | 6pcs Kit | | | |
| LED Colour | Single | RGB | Single | RGB | Cool White | RGB | Cool White | RGB |
| Cut-Out (mm) | Ø51mm | | 51 x 51mm | | Ø51mm | | 51 X 51mm | |
| Size (mm) | Ø58 x 9 | | 58 x 58 x 9 | | Ø58 x 9 | | 58 X 58 X 9 | |
| Material | 304 Stainless Steel | | | | 304 Stainless Steel | | | |
| Connection | 1m Cable with male plug | | | | 1m Cable with male plug | | | |

*Add colour to code: ● R (Red), ● B (Blue), ● Y (Yellow), ● G (Green), ○ CW (Cool White), ○ WW (Warm White)

| Code | SC-B103B-* | SC-B104B-* | SC-B104C | SC-B105B-* | SC-B106B-* |
|--------------|-------------------------|-------------------------------------------|----------|-------------------------------------------|---------------------------|
| Power | 0.4W | 0.4W | | 0.3W | 0.23W |
| No. of LEDs | 1pcs | 1pcs | | 1pcs | 1pcs |
| LED Colour | Single | Single | RGB | Single | Single |
| Cut-Out (mm) | Ø51mm | Ø33mm | | Ø24mm | Ø24mm |
| Size (mm) | Ø58 x 9 | Ø40 x 19 | | Ø30 x 19 | Ø35 x 31 |
| Material | 304 Stainless steel | 304 Stainless steel | | 304 Stainless steel | Die Cast Aluminium |
| Connection | 1m cable with Male plug | 2 x 1m cable with Male plug & Female plug | | 2 x 1m cable with Male plug & Female plug | 1m cable with Female plug |

*Add colour to code: ● R (Red), ● B (Blue), ● Y (Yellow), ● G (Green), ○ CW (Cool White 6500K), ○ WW (Warm White)

Connectors & Accessories



| Code 2 Wire (Single Colour) | Code 4 Wire (Colour Changing) | Description |
|-----------------------------|-------------------------------|-------------------------------------------------------------------------------------------------------------------------------------|
| SC-Z103A-3M | SC-Z103B-3M | 3m Cable with male & female Connectors |
| SC-Z102 | SC-Z103 | 5pcs "T" Connection Cable - 0.5m between pieces |
| SC-Z105A | SC-Z105B | Waterproof "T" Connector |
| SC-Z106A | SC-Z106B | Waterproof Connection Box |
| | SC-Y1230 | 12VDC power supply for use with Deck lights 0.3m cable with female plug. Supply voltage: 90-264VAC Max loading: 30W (2.5A) 12VDC |
| - | SC-Z101 | RGB controller for use with deck lights with 0.5m input and output cables IP67 |



SOLAR IN-GROUND LIGHTS

| SOLAR Batteries Included | Stainless Steel In-ground Series IP44 | | | | In-ground IP68 | Paving Lamp IP44 |
|-----------------------------|----------------------------------------------|----------------|-----------------|---------------------|-----------------------|-------------------------|
| | RW2LED-120 | RW3LED-120 | SDDM002 | SDDM002-2 | ZH-03-W | RW-SLR001 |
| SOL2 | | | | | | |
| Code | RW2LED-120 | RW3LED-120 | SDDM002 | SDDM002-2 | ZH-03-W | RW-SLR001 |
| Size (mm) | Ø120 x 35D | Ø120 x 35D | 125 x 125 | 125 x 125 | Ø50 x 35 | Ø120 x 35D |
| Type | 2 x White LED | 3 x White LED | 4 x White LED | RGB colour changing | 1 x White LED | 1 x LED |
| Batteries | 1 x NiMh 600mA | 2 x NiMh 600mA | 1 x NiMh 600mAh | 1 x NiMh 600mAh | 1 x NiMh 350mAh | 1 x NiMh 600mA |

EMPTY INGROUND LIGHTS - IP67

Lamps excluded | Stainless Steel

| | | | | |
|----------------|------------------|------------------|------------------|-------------------|
| | | | | |
| Code | MXD-100-1 | MXD-100-3 | MXD-100-6 | MXD-120-1F |
| Lamp Holder | MR16 | MR16 | MR16 | MR16 |
| Size | Ø100 x 120 | Ø100 x 120 | Ø100 x 120 | Ø120 x 130 |
| Hole Size (mm) | Ø90 x 120 | Ø90 x 120 | Ø90 x 120 | Ø98 x 130 |
| | | | | |
| Code | NB1033-D | NB1033-A | NB1033-C | |
| Lamp Holder | MR16 | GU10 | E27 | |
| Size | Ø100 x 156 | 98 x 98 x 147 | Ø154 x 255 | |
| Hole Size (mm) | Ø90 x 156 | Ø88 x 147 | Ø144 x 255 | |

LED INGROUND LIGHTS IP66

Supply Voltage: 230VAC | Material: Stainless Steel

| | | | |
|----------------|------------------|--------------------|------------------------|
| | Fixed | Fixed | Angle: 30° (Fixed) |
| Code | NCC-180C* | NCC-260C* | NCC-250-3* |
| LED | 10W | 30W | 9W |
| Lumens | 1000lm | 3000lm | 900lm |
| Size (mm) | Ø180 x 115 | Ø260 x 120 | Ø250 x 210 |
| Hole Size (mm) | Ø170 x 120 | Ø240 x 120 | Ø240 x 150 |
| | Tilttable | Fixed | Fixed |
| Code | XGN-T260* | MXD-100-7* | MXD-100-8* |
| LED | 18W | 3W | 3W |
| Lumens | 1800lm | 300lm | 300lm |
| Size (mm) | Ø260 x 325 | Ø100 x 75 | Ø100 x 75 |
| Hole Size (mm) | Ø248 x 335 | Ø90 x 75 | Ø90 x 75 |
| | Tilttable | | |
| Code | XGN-C210* | LED-3739/4* | WL11009A* |
| LED | 7W | 28 X 0.1W (2.3W) | 12 x 0.08W (1W) |
| Lumens | 700lm | 84lm | 10lm |
| Size (mm) | Ø210 x 270 | Ø145 x 130 | 100Ø x 80D |
| Hole Size (mm) | Ø195 x 280 | Ø135 x 130 | Ø90 x 80 |

Add colour to code: *○ CW (Cool White), ○ WW (Warm White)
 *○ WH (White), ● BL (Blue), ● Y (Yellow), ● GN (Green), ● R (Red)
 *○ CW (Cool White), ○ WW (Warm White), ● R (Red), ● GN (Green), ● BL (Blue), ● Y (Yellow)
 *○ CW (Cool White), ● BL (Blue)

GARDEN SPOT LIGHTS

Spot Lights

Lamps excluded



Ø97 x H155mm



Ø63 x H157 x D77mm

| | | | |
|------------------|-------------------------|------------------------|-----------------|
| Code | NB1036 | NB1057-D | C7033-ST |
| Lamp | Max. 50W 12V MR16 | Max. 75W PAR38 (ACL91) | MR16 35W 12V |
| Lamp Holder | MR16 | E27 | GU 5.3 |
| IP Rating | IP65 | IP65 | IP54 |
| Material | Die Cast Aluminium body | Stainless Steel | Stainless Steel |

EMPTY GARDEN SPIKE LIGHTS

Lamps excluded

IP65

IP65

IP65

IP65

IP65

| | | | | | |
|-------------|-------------------------|-------------------------|-------------------------|-------------------------|-------------------------|
| Code | NB1038 | NB1036-B | NB1037 | NB1051 | NB1052 |
| Lamp | Max. 50W 12V MR16 | Max. 50W 12V MR16 | Max. 50W 12V MR16 | Max. 50W 12V MR16 | Max. 50W 12V MR16 |
| Lamp Holder | MR16 | MR16 | MR16 | MR16 | MR16 |
| Material | Die Cast Aluminium body | Die Cast Aluminium body | Die Cast Aluminium body | Die Cast Aluminium body | Die Cast Aluminium body |

 PAR38
IP44

IP44

IP44

IP65

| | | | | |
|-------------|---------------|-----------------|-----------------|--------------------|
| Code | NB1070 | NB1074 | EL200660 | C800-504 |
| Lamp | Max. 80W | PL-13-CW | Max. 120W | 3 x MR16 20W |
| Lamp Holder | E27 | G23 | 2 x E27 | GU4/GZ4 |
| Material | ABS Plastic | ABS Plastic | Thermo Plastic | Die-cast Aluminium |

GARDEN SPIKE LIGHTS

Supply Voltage: 230VAC

IP65 **LED**

Optional lenses:
● RW-LED-4-LENS-BL
● RW-LED-4-LENS-R
● RW-LED-4-LENS-G

IP65 c/w 12V transformer **LED**

IP68 **LED**

IP20 S.Steel + Glass Trim **LED**

Plastic Spot Lamp **SOLAR**
IP67
 Battery: 1 x NiMH 600mA

SOL2

| | | | | | |
|-------------|--------------------|--------------------|-------------------|---------------------|------------------|
| Code | RW-LED-4-CW | RW-LED-18-* | LED-9030-* | LED-3031AS-* | RW-SLP006 |
| LED's | 4W | 3 x 6W | 3 x 1 (3W) | 3 x 1W (3W) | 1 x LED |
| Lumen | 220lm | 280lm x 3 | 270lm | 90lm | 150lm |
| Size (mm) | Ø72 x 257 | Ø72 x 257 | Ø98 x 320 | Ø65 x 350 | 160 x 85 x 330 |

*Add colour to code: ○ **CW** (Cool White), ● **BL** (Blue), ● **R** (Red), ● **G** (Green), ● **Y** (Yellow)

Outdoor

LIGHTING

SOLAR GARDEN LIGHTS IP44

SOLAR

- Batteries Included
- Height does not include spike

SOL2



| Code | RW-SF-03-8 | RW-SF-03-2 | RW-SF-02-1 | RW-SF-03-4 | RW-SLS004 | E2009 | CON-SOLAR |
|------------|-----------------|-----------------|-----------------|-----------------|-----------------|-----------------|--------------------|
| Size (mm) | 320H x 115Ø | 455H x 120Ø | 605H x 138Ø | 325H x 125Ø | 360 x 115Ø | 390H x 130Ø | 1 Litre Consol Jar |
| Type | 1 x LED | 1 x LED | 1 x LED | 1 x LED | 1 x LED | 1 x LED | 4 x LED |
| Batteries: | 1 x NiMh 600mAh | 1 x NiMh 600mAh | 1 x NiMh 600mAh | 1 x NiMh 600mAh | 1 x NiMh 600mAh | 1 x NiMh 600mAh | 2x1.2V 600mAh AAA |
| Material | Plastic | Plastic | Plastic | Plastic | Stainless Steel | Stainless Steel | Glass |

SOLAR

- Batteries Included
- Height does not include spike

SOL2



| Code | RW-SLS001 | RW-SLS002 | RW-SLS003 | SDBX115 | S-1718 | ESL-10 | SL-04M |
|------------|-----------------|-----------------|-----------------|-----------------|----------------------|----------------|-----------------------|
| Size (mm) | 307.5H x 150Ø | 480H x 170Ø | 365H x 125Ø | 420H x 170Ø | 570 x 115 x 90 | 800mm (H) | 510(H) x 110Ø |
| Type | 1 x LED | 1 x LED | 1 x LED | 1 x LED | 15 LEDs (200lm) | 1 x LED | 1 x LED |
| Batteries: | 1 x NiMh 600mAh | 1 x NiMh 600mAh | 1 x NiMh 600mAh | 1 x NiMh 600mAh | 1x3.7V 1800mAh 18650 | Li-ion Battery | Li-ion Battery 450mAh |
| Material | Stainless Steel | Stainless Steel | Stainless Steel | Stainless Steel | PC + ABS | PC & Aluminium | Stainless Steel |

DECORATIVE GARDEN SPIKE LIGHTS IP44

Supply Voltage: 230VAC | c/w 230/12V Transformer

c/w 230/12V Transformer & 3-in-1 connector

| Code | KH833S-* | KH834S-* | KH833-* | KH105 | KH342 |
|-----------|-------------------|-------------------|-------------------|------------------|------------------|
| Lamp | 2 x 0.12W (0.24W) | 3 x 0.12W (0.36W) | 3 x 0.72W (0.24W) | G6.35 (G4) / 10W | G6.35 (G4) / 10W |
| Lumen | 6lm | 9lm | 9lm | 55lm | 55lm |
| Size (mm) | Ø25 x 294 | Ø51 x 315 | Ø38 x 260 | Ø90 x 312 | Ø38 x 300 |

* Add colour to code: ○CW (Cool White), ●BL (Blue)

| Code | KH810-* | KH825-* | CIE-L003 | BF-SGL1-W |
|-----------|-------------------|-------------------|---------------|---------------------|
| LEDs | 9 x 0.12W (1.08W) | 9 x 0.12W (1.08W) | 2 x 6 x 0.06W | Flame Effect LED 1W |
| Lumen | 27lm | 27lm | 36lm | 150lm |
| Size (mm) | Ø60 x 260 x 100 | Ø60 x 110 | Ø200 x 450 | Ø137 x 1000 |

* Add colour to code: ○CW (Cool White), ●BL (Blue)

Colour: White only

Flame Effect Torch Spike

IP65
Battery:
1 x LiPO
2000mA

SOL2



Outdoor

LIGHTING

STAINLESS STEEL BOLLARDS

| | | | | | | |
|------------------------|------------------|------------------|------------------|--------------------|--------------------|---------------------------|
| Supply Voltage: 230VAC | | | | | | |
| * Add Colour to code | | | | | | |
| Code | TL-ST-06E | TL-ST-06D | TL-ST-06C | KH836-SS | KH834-PSH | CIE-L006-300-* |
| LEDs | 2 x 6W | 2 x 6W | 2 x 6W | 24 x 0.12W (2.88W) | 16 x 0.12W (1.92W) | 16 x 0.12W (1.92W) |
| Lumen | 550lm | 550lm | 550lm | 66lm | 48lm | 550lm |
| IP Rating | IP44 | IP44 | IP44 | IP44 | IP44 | IP44 |
| Size (mm) | Ø76 x 870 | Ø76 x 675 | Ø76 x 520 | Ø76 x 300 | Ø80 x 400 | Ø76 x 520 |
| Colour Temp | 4200K | 4200K | 4200K | 4200K | 4200K | *CW / ●R / ●GN / ●BL / ●Y |

| | | | | | | |
|--------------------------------------------------|---------------------|-----------------|-----------------|----------------------|------------------|-----------------|
| Supply Voltage: 230VAC Order Lamps separately | | | | | | |
| Code | C300-224-650 | C300-224 | YF-B5207 | CIE007-1-1050 | CIE007-2H | C300-216 |
| Lamp | 60W Max | 60W Max | 60W Max | 60W Max | 2x60W Max | 40W Max |
| Lamp Holder | E27 | E27 | E27 | E27 | E27 | E27 |
| IP Rating | IP44 | IP44 | IP44 | IP44 | IP44 | IP44 |
| Size (mm) | Ø200 x 650 | Ø250 x 1175 | Ø250 x 800 | Ø200 x 1050 | Ø200 x 1180 | Ø120 x 800 |

| | | | | | |
|--------------------------------------------------------------------------------------------|-------------------|---------------------|-------------------|--------------------|-------------------|
| Supply Voltage: 230VAC Material: PP Plastic & Stainless Steel Order Lamps separately | | | | | |
| Code | CIE007-500 | CIE007-1-500 | CIE016-600 | CIE014S-450 | CIE014-450 |
| Lamp | 100W Max | 100W Max | 60W Max | 60W Max | 60W Max |
| Lamp Holder | E27 | E27 | E27 | E27 | E27 |
| IP Rating | IP44 | IP44 | IP44 | IP44 | IP44 |
| Size (mm) | Ø200 x 380 | Ø200 x 380 | Ø76 x 600 | Ø76 x 450 | Ø75 x 450 |

DIE-CAST ALUMINIUM BOLLARDS

| | | | | |
|-------------------------------------------------------------------|-----------------|-----------------|-----------------|-----------------|
| Supply Voltage: 230VAC Die Cast Aluminium Colour: Dark Grey | | | | |
| Code | YSC-1007 | YSC-1004 | YSC-1000 | YSC-1002 |
| Wattage | 5W | 5W | 5W | 5W |
| Lumens | 500lm | 500lm | 500lm | 500lm |
| IP Rating | IP54 | IP54 | IP54 | IP54 |
| Size (mm) | 76 x 76 x 800 | 50 x 120 x 800 | 60 x 102 x 800 | 100 x 160 x 850 |

Outdoor

LIGHTING

EMPTY BOLLARDS

Supply Voltage:
230VAC
Die-cast
Aluminium
Bodies
Lamps excluded
IP44



| Code | YSC-3011 | YSC-3030 | YSC-3039 | YSC-3048 | YSC-3024 |
|-----------|----------------|-----------------|----------------|----------------|----------------|
| Lamp Base | E27 (18W Max.) | E27 (18W Max.) | E27 (18W Max.) | E27 (18W Max.) | E27 (18W Max.) |
| IP Rating | IP44 | IP44 | IP44 | IP44 | IP44 |
| Size (mm) | 158 x 800 | 200 x 100 x 700 | Ø160 x 800 | Ø160 x 740 | 160 x 700 |

Supply Voltage:
230VAC
Die-cast
Aluminium
Bodies
Lamps excluded



| Code | YSC-3028 | YSC-3078 | YSC-3085 | NB3077 |
|-----------|----------------|----------------|----------------|-----------------|
| Lamp Base | E27 (18W Max.) | E27 (18W Max.) | E27 (18W Max.) | E27 (100W Max.) |
| IP Rating | IP44 | IP44 | IP44 | IP44 |
| Size (mm) | 160 x 750 | Ø280 x 600 | Ø220 x 600 | Ø205 x 650 |

Supply Voltage:
230VAC
Die-cast
Aluminium
Bodies
Lamps excluded



| Code | NB3078 | NY21836R | NY11836R* |
|-----------|-------------|-------------|-------------|
| Lamp Base | E27 | 2 x E27/75W | E27/75W |
| IP Rating | IP44 | IP54 | IP54 |
| Size (mm) | Ø170 x 650 | 260 x 990 | 124 x 990 |

Add **SC** to code for smokey clear lense

SOLAR BOLLARDS & POST TOPS

SOLAR

- 6-8 Hours Normal Brightness
- Aluminium Body & Glass Lamp Shade
- Auto Turn On / Off Dusk & Dawn

SOL2

Solar Bollards IP44



Solar Post Tops IP44



| Code | JY-0012-C | JY-0007-C | JY-0008-C | JY-0012-D | JY-0007-D | JY-0008-D |
|---------|-------------|-------------|-------------|-------------|-------------|-------------|
| Wattage | 2.4W | 3W | 4W | 2.4W | 3W | 4W |
| Lumens | 130lm | 220lm | 220lm | 130lm | 220lm | 220lm |
| Size | Ø220 x 1400 | Ø260 x 1300 | Ø280 x 1300 | Ø220 x 1800 | Ø260 x 1750 | Ø280 x 1750 |

POST TOPS

Supply Voltage: 230VAC
Lamps Excluded
Pole Included
Material: Steel

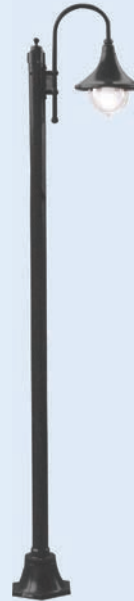

| Code | LH-5004G | LH-5004G-2.4M | LH-5004-3G | LH-5029G | LH-5029-2G | LH-5029-3G |
|-----------|-------------|---------------|--------------|-------------|-------------|-------------|
| Lamp | E27/100W | E27/100W | 3 x E27/100W | E27/60W | 2 x E27/60W | 3 x E27/60W |
| IP Rating | IP44 | IP44 | IP44 | IP54 | IP54 | IP54 |
| Size (mm) | 1200(H) | 2400(H) | 2280(H) | 2360(H) | 2360(H) | 2360(H) |

POST TOP HEADS IP55

Input Voltage: 220 - 240VAC

LED



Colour Temp: 6000K

LED



Colour Temp: 6000K

LED



Colour Temp: 6000K

LED



Colour Temp: 4200K

LED



Colour Temp: 4200K

| Code | 01-006-LED | RW-GL-LED-30W | RW-GL-LED-50W | AG-008 | K-ST-60-P |
|-----------|--------------------|--------------------|--------------------|--------------------|--------------------|
| Max Power | 40W | 30W | 50W | 50W | 60W |
| Lumens | 4000lm | 3000lm | 5000lm | 5400lm | 6000lm |
| Size (mm) | Ø700 X 460 | Ø160 x 600 | Ø485 x 695 | Ø500 x 660 | Ø600 x 160 |
| Material | Die Cast Aluminium | Die Cast Aluminium | Die Cast Aluminium | Die Cast Aluminium | Die Cast Aluminium |
| Entry | Ø76 | Ø76 | Ø76 | Ø60 | Ø76 |

Input Voltage: 220 - 240VAC



Empty



| Code | YZTH-859-EMPTY | 01-006-* | YZTH-862-* | 521LED-MT |
|-------------|--------------------|--------------------|--------------------|--------------------|
| Max Power | 70W-150W | 70W-150W | 70W-150W | Max. 150W |
| Lamp Holder | E27 | E27 | E27 | E27 |
| Size (mm) | Ø738 x 560 | Ø700 x 460 | Ø380 x 333 | Ø400 |
| Material | Die Cast Aluminium | Die Cast Aluminium | Die Cast Aluminium | Die Cast Aluminium |
| Entry | Ø76 | Ø76 | Ø60 | Ø76 |

* Add type of switch gear required: **70W** (Metal Halide), **150W** (Metal Halide), **EMPTY** (No switch gear)

POLES



| Code | POLE-3.5M-76 |
|-------------|------------------|
| Pole length | 3500mm |
| Pole Top Ø | 76mm |
| Material | Galvanised Steel |

Outdoor

LIGHTING

LED SPOTS IP65



LSP-3X3W-12V

LSP-6X3W-24V



DMX-512

| Code | Power | Lumen | Size (mm) |
|----------------|---------------------|--------|------------|
| LSP-3X3W-12V-* | 9W (0.75A) @ 12VDC | 1780lm | Ø99 x 129 |
| LSP-6X3W-24V-* | 18W (0.75A) @ 24VDC | 3400lm | Ø120 x 168 |

*Add colour to code: ● R (Red), ● GN (Green), ● BL (Blue), ● Y (Yellow), ●● RGB, ○ CW (Cool White)
Beam angle - Single colour: 30°, RGB: 40°

Accessories

| Code | Description |
|-------------|-------------------------------------|
| DMX-512-12V | DMX controller to control RGB type |
| IMG-DV512 | DMX decoder driver 12/24V, 180W max |

Order one DMX controller and at least one decoder driver for each colour changing installation.



IMG-DV512

| | | | | |
|---------------------------|---------------------|--------------------|-------------------------------------------------------------------------------------------------|------------------|
| Supply Voltage 230 VAC | | | | |
| Code | HLB00802-RGB | HLB00801-WW | SL-T213-* | SL-T211-* |
| Power | 12 x 1.0W (12W) | 12 x 1.0W (12W) | 6 x 1W (6W) | 18 x 1W (18W) |
| Lumen | 552 | 552 | 480-540 | 1440-1620lm |
| Size (mm) | Ø110 x 208 | Ø110 x 208 | Ø120 x 200 | Ø180 x 260 |
| Light Distance | 8m | 8m | 5m | 12m |
| Colour | RGB | ○ WW (Warm White) | *Add colour to code: ○ CW (Cool White), ○ WW (Warm White), ● R (Red), ● BL (Blue), ● Y (Yellow) | |

UNDERWATER LIGHTS IP68

| | | | | | |
|-------------------------------|---------------------|------------------|--------------------|------------------|--------------------------------------------------------|
| Lamps & Transformers Excluded | | | | | Outdoor |
| Code | C7062 | C7052 | C7162 | LH5001-9A | |
| Lamp | MR16 35W 12V | 80W 230V | MR16 35W 12V | MR16 50W 12V | LIGHTING |
| Lamp Type | GU5.3 | E27 | GU5.3 | GU5.3 | |
| Material | Stainless Steel | Stainless Steel | Stainless Steel | PBT | |
| Size (mm) | Ø82 x 152 x 110 | Ø155 x 260 x 200 | Ø82 x 300 x 110 | Ø85 x 110 | |
| | | | | | Colour Lenses - To be ordered separately |
| Code | LH5001-4 | LH5001-3 | DH28462 | DH-* | *Add colour to code: ● R, ● GN, ● BL, ○ CL, ● Y, |
| Lamp | MR16 50W 12V | PAR 56 300W 12V | PAR56 120-300W 12V | | |
| Lamp Type | GU5.3 | Screw Terminals | Screw Terminals | | |
| Spare Lamp | Brass Nickel Plated | ABS | Stainless Steel | | |
| Size (mm) | Ø95 x 115 | Ø228 x 215 | Ø215 x 230 | | |

LED UNDERWATER LIGHTS IP68

Supply volts:
12VDC

NEW



Supply volts:
12VDC

NEW



Supply volts:
12V



Supply volts:
12V RGB
c/w remote



| Code | HLB01901-12VDC* | HLB01801-12VDC* | GLD005* | GLD-RGB-10W |
|----------|---------------------|---------------------|---------|-------------|
| Power | 6W | 9W | 4.5W | 10W |
| Lumen | 600lm | 900lm | 45lm | 750lm |
| Size(mm) | Ø120 x 155 | Ø180 x 145 | Ø120 | Ø75 x 91 |
| Material | 304 Stainless Steel | 304 Stainless Steel | ABS | Aluminium |

*Add colour to code: ○ WW (Warm White), ○ CW (Cool White),
● BL (Blue)

*Add colour to code: ○ W (White), ● R (Red), ● G (Green),
● BL (Blue), ●●● M (RGB)



Input Voltage: 24VAC/DC | c/w 2 Meter cable

| Code | Size (mm) | Watts | No of LEDs |
|--------|-----------|-------|------------|
| UD14-M | Ø53 x 35 | 1.5 | 15 |
| UD15* | Ø53 x 35 | 1.5 | 15 |

*Add colour to code: ● R, ● G, ● B, ○ W, ● Y, ● P -M = Multi-colour (Full colour changing ●●●)

LED AQUA POOL LIGHTS IP68



Surface Mount

| Code | Wattage | Voltage | Lumen | Beam Angle | Size (mm) |
|-------|--------------|-------------|--------|------------|-----------|
| P120* | 20W (1700mA) | 12-24VAC/DC | 1500lm | 120° | Ø250 x 50 |

*Add colour to code: ○ W (White), ● B (Blue), ●●● RGB (Colour Changing)



PAR56 Retrofit Lamp

| Code | Wattage | Voltage | Lumen | Beam Angle | Size (mm) |
|---------|--------------|-------------|--------|------------|-----------|
| PAR120* | 20W (1700mA) | 12-24VAC/DC | 1500lm | 120° | Ø180 x 77 |

*Add colour to code: ○ W (White), ● B (Blue), ●●● RGB (Colour Changing)



Spa and Jacuzzi LED

| Code | Wattage | Voltage | Lumen | Beam Angle | Size (mm) |
|----------|---------|----------|-------|------------|-----------|
| P50SPA-B | 4W | 12VAC/DC | 400lm | 60 - 90° | Ø110 x 63 |

NEW



Back

Front

Aim Flow Powered Pool & Spa LED - Jet Hole Mounting | No External Power Required - Self Generating

| Code | Wattage | Voltage | Lumen | Beam Angle | Size (mm) |
|--------|---------|-------------|-------|-------------|-----------|
| JHM-L* | 0,1W | Self Driven | 10lm | 60-90° (2m) | Ø45 x 40 |

*Add colour to code: ○ CW (Cool White), ● BL (Blue), ● GN (Green)



PN10W



Side View

PN-NICHE

Niche Mount - Retrofit to a Standard Wet Niche

| Code | Wattage | Voltage | Lumen | Beam Angle | Size (mm) |
|--------|---------|-------------|--------|------------|-----------|
| PN10W* | 20W | 12-24VAC/DC | 1500lm | 60-90° | Ø300 x 60 |

*Add colour to code: ○ W (White), ● B (Blue)

Accessories

| Code | Description |
|----------|-------------|
| PN-NICHE | Pool Niche |

Accessories

| Code | Description |
|-------|------------------------------------------------------------------------------------------------|
| PLA05 | Output 12V, 150VA, Outdoor Transformer, 1-6 pieces |
| PLA06 | 10A Underwater Connector |
| PLA07 | PAR56 Pool Light Plastic Case Housing |
| PLA09 | External R.F Remote System, Control device power on/off, Select programme, Synchrony programme |



PLA07



PLA05



PLA06



PLA09

FIBRE OPTIC POOL LIGHTING

Solid Core Fibre Optic Side Light

- Economic replacement of neon lighting
- Safe – no safety shield required
- Neutral colour fibre, colour added with light engine

Minimum bend radius: 4 x core diameter

Ambient: -20 to +120°C

Loss: 6%/m

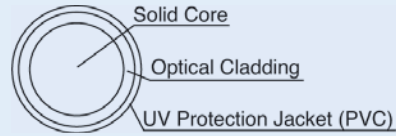

Solid Core Side Light

| Code | Core Ø | Outside Ø | Length | Shielding Colour |
|------------|--------|-----------|--------|------------------|
| OFS-60-30 | 6mm | 8.8mm | 30m | Clear |
| OFS-100-30 | 10mm | 13.0mm | 30m | Clear |

Multi-String Side Light

| | | | | |
|--------------|---|--------|-----|-------|
| MOFS-3-14-30 | – | 8.6mm | 30m | Clear |
| MOFS-6-14-30 | – | 12.6mm | 30m | Clear |

Crystifiber Solid Core Side Light

| | | | | |
|-------------|------|--------|-----|-------|
| COFS-60-30 | 6mm | 9.4mm | 30m | Clear |
| COFS-100-30 | 10mm | 14.2mm | 30m | Clear |

Used for lighting of swimming pools, spas and building outlining



Accessories

| Code | Suitable for | Size | Description |
|---------|-------------------------|---------|-------------------------------|
| NTS-009 | OFS-60/MOFS-6/COFS-60 | 8-9mm | Extended Clip |
| NTS-012 | OFS-100/COFS-100 | 12-13mm | Extended Clip |
| OF-2-9 | OFS-6/COFS-6 | 9mm | Crocodile Clip |
| OF-1-9 | OFS-6/MOFS-6/COFS-60 | 9mm | Clear Channel Plastic 1.8m |
| OF-1-13 | OFS-100/COFS-100 | 13mm | Clear Channel Plastic 1.8m |
| OF-3 | OFS-60/100, COFS-60/100 | – | Fiber Cutter for Solid Core |
| OF-4 | MOFS-6 | – | Fibre Cutter for Multi-string |



H-50/100
• Wall Mounting
• Wired Remote



R-150
• Continuous change in colour
• Colour changed by stepping
• Fixed colour display
R-150 DMX M/S/D
• Programmable VID DMX Controller
• Sound activated
• Dimming
• Rainbow effect



R-150
Colour Wheels

Light Engines (Indoor) 230V

| Code | Lamp | Motor | Lamp Life |
|-----------------|------------------|----------|-----------|
| H-50 | Halogen 12V 50W | 2-5rpm | 4000hrs |
| H-100 | Halogen 12V 100W | 2.5rpm | 4000hrs |
| R-150 | HQI-R 150W | Stepping | 6000hrs |
| R-150 DMX M/S/D | HQI-R 150W | Stepping | 6000hrs |
| SRC-144 | DMX Controller | – | – |



DMX Controller

- 54 Channels DMX Output up to 9 projectors
- 4 Digit LED Display showing program/run speed/cross time
- 9 Programs and each program up to 50 steps
- DMX Signal: 3 pin XLR female x1
- Power input: DC 9V-12V 500mA (Adaptor is included)



FRP-001

FRP-003



FRP-002

FRP-004



FRP-005

Fibre Optic Kits

| Code | Light Engine | Fibre Size | No. of Fibres | Length of Fibres | End Piece |
|---------|--------------|------------|---------------|----------------------------------------|-------------|
| FRP-001 | LED MINI | 0.75mm | 155 | 2m | – |
| FRP-002 | H-20 | 0.75mm | 25 x 4 | 2, 3, 4, 5m | FO-033 |
| FRP-003 | H-35 | 1.0mm | 120 | 2m | FO-034 |
| FRP-004 | H-50 DMX | 1.0mm | 32 | 8x0.8m, 6x1.2m, 6x1.8m, 6x2.2m, 6x2.5m | FECU-10-1.0 |
| FRP-005 | H-50T | 0.75mm | MOFSSS-14 x 1 | 10m | – |

POOL LIGHTS

Recessed Mounting

Supply Voltage: 12VAC



| Code | PL100-10 | PL300-10 | PLP300-10 | PS100-10 |
|------------|----------------------|---------------|---------------|------------------------|
| Power | 100W | 300W | 300W | 100W |
| Lamp Type | PAR36 (incl.) | PAR56 (incl.) | PAR56 (incl.) | 2 X JC (G6.35) (incl.) |
| Size (mm) | Ø165 x 110 | Ø270 x 125 | Ø270 x 125 | Ø280 x 50 |
| Spare Lamp | Lamp not replaceable | ACL81 | ACL81 | - |

c/w Standard 10m cable.

Supply Voltage: 12VAC

LED - Surface Mounting



LED S/Steel - c/w internal controller



| Code | PAR56-270-BL | CM-P007-M | RW-SLB003 | RW-SLB002 |
|-----------|--------------|-----------|-----------|-----------|
| Power | 15W | 12-16W | 1W | 1W |
| Lamp Type | Blue LEDs | LED (RGB) | 2 x LED | 2 x LED |
| Size (mm) | Ø290 x 60 | Ø 210mm | Ø120 | Ø160 |

Plastic Floating Lamps IP67

SOL2

SOLAR

SOLAR



Battery: 1 x NiMh 600mA

Battery: 1 x NiMh 600mA



LED PAR 56 & PAR46 Lamp - Supply Volts - 12VAC (Suitable for Swimming Pools)

| Code | Power | Lumen (MCD) | *Add Colour to Code: |
|------------|-------------------|----------------------------------------------------------|-----------------------------------|
| HG-PAR56-* | 18W | R & Y=1500-2500, G=7000-9000 B=2000-2500, W=6000-8000 | ● R / ● G / ● Y / ● B / ● M (RGB) |
| HGP56AUTO | 18W Auto changing | RGB=2000-3500 | ● ● ● Auto |

Remote supplied with M (Multicolour) only

Outdoor

LED PAVING BRICK LIGHTS IP67



LED-Q02GN

LED-Q02BL

LED-Q02W

LED Paving Brick Lights

| Code | Wattage | No of LED's | Size (mm) |
|------------|---------|-------------|-----------------------|
| LED-Q02*-† | 1.5W | 9 | 80(H) x 80(L) x 68(W) |

*Add colour to code: ○ W (White) ● R (Red), ● GN (Green), ● BL(Blue), ● Y (Yellow),

● ● ● RGB (auto colour changing)

† Add voltage to code: 230VAC, 24VAC

LIGHTING

LED FLOOR TILE LIGHTS IP65

• Material: Ceramic Surface with sealed ceramic base (LEDB5 & B6) • Stainless Steel (LEDB7)

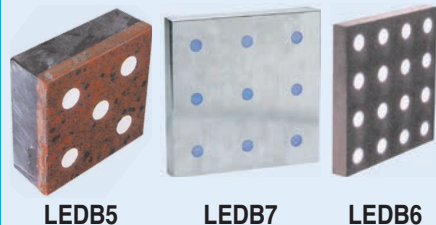

LEDB5

LEDB7

LEDB6

| Code | Voltage | Power mA | | Size (mm) | No. of Dots | Material |
|---------|---------|---------------|---------------|----------------|-------------|-----------------|
| | | R, G, Y, B, W | M (R, G, B) | | | |
| LEDB5-* | 24VDC | 20mA (0.48W) | 54mA (1.3W) | 100 x 100 x 35 | 5 | Ceramic |
| LEDB6-* | 24VDC | 100mA (2.4W) | 180mA (4.5W) | 200 x 200 x 40 | 16 | Marble |
| LEDB7-* | 24VDC | 53mA (1.27W) | 160mA (3.84W) | 200 x 200 x 30 | 9 | Stainless Steel |

*Add colour to code: ● R, ● G, ● Y, ● B, ○ W, ● ● ● M (R, G, B colour changing)

All Paving Bricks supplied with 2 cables 1 meter long connected with 1x male, 1x female plug.

Power supply to be ordered separately, see page 106-108.

LED PAVING BRICK LIGHTS IP66

| | | | | | | | | | | | | |
|---------------------------|-------------------------------------|---------------|------------------|---------------|------------------|-----------|------------------|------------|-----------|---------------|------|-----|
| 50 000 Hours average life | Rippled Glass | Frosted Glass | Frosted Glass | Marble Finish | | | | | | | | |
| | | | | | | | | | | | | |
| | B1 | B2 | B3 | B4 | | | | | | | | |
| Size | 100 x 100 x 50mm | | 100 x 200 x 70mm | | 200 x 200 x 70mm | | 200 x 200 x 70mm | | | | | |
| Colour | Code | LUX | mA | Code | LUX | mA | Code | LUX | mA | | | |
| ● Red | LEDB1-R* | 180 | 20 | LEDB2-R 24VDC | 63 | 60 | LEDB3-R 24VDC | 138 | 120 | LEDB4-R 24VDC | 138 | 120 |
| ● Green | LEDB1-G* | 508 | 20 | LEDB2-G 24VDC | 189 | 60 | LEDB3-G 24VDC | 450 | 120 | LEDB4-G 24VDC | 450 | 120 |
| ● Yellow | LEDB1-Y* | 181 | 20 | LEDB2-Y 24VDC | 71 | 60 | LEDB3-Y 24VDC | 84 | 120 | LEDB4-Y 24VDC | 84 | 120 |
| ● Blue | LEDB1-B* | 690 | 20 | LEDB2-B 24VDC | 202 | 60 | LEDB3-B 24VDC | 600 | 120 | LEDB4-B 24VDC | 600 | 120 |
| White | LEDB1-W* | 680 | 20 | LEDB2-W 24VDC | 210 | 60 | LEDB3-W 24VDC | 246 | 120 | LEDB4-W 24VDC | 246 | 120 |
| R,G,Y,B | LEDB1-M 24VDC | 1351 | 60 | LEDB2-M 24VDC | 452 | 180 | LEDB3-M 24VDC | 1150 | 360 | LEDB4-M 24VDC | 1150 | 360 |
| Colour changing | *Add V to Code 12VDC, 24VDC, 230VAC | | | | | | | | | | | |

All Paving Bricks supplied with 2 cables 1 meter long connected with 1x male, 1x female plug. Power supply to be ordered separately for 24V

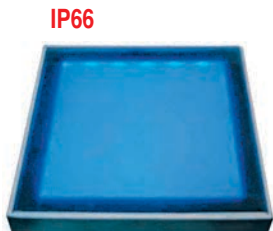

| Code | Power mA | | No of LEDs | Size (mm) | Material |
|---------|---------------|---------------|------------|----------------|-----------------------------|
| | R, G, Y, B, W | M (R, G, B) | | | |
| LEDB8-* | 60mA (1.5W) | 180mA (2.88W) | 60 | 100 x 100 x 20 | Frosted Glass with S/S trim |
| LEDB9-* | 120mA (5.2W) | 360mA (8.64W) | 120 | 200 x 200 x 20 | Frosted Glass with S/S trim |

*Add colour to code: ● R, ● G, ● Y, ● B, ○ W, M (●●● R, G, B colour changing [Only in 24VDC]).

*Add voltage to Code 24VDC, 230VAC

24VDC Supply: Paving Bricks supplied with 2 cables 1 meter long connected with 1x male, 1x female plug. Power supply to be ordered separately.

230VAC Supply: Paving Bricks with 230VAC supply for Indoor use only. Supplied with 200mm single cable.

Accessories

| Code | Description |
|--------|-----------------------------------|
| LED-EP | End Plug for 2 & 4 Pin Plugs IP65 |

Power Supplies for Single Colour Paving Lights (2 wire only).

No electronic controller

| Code | Volts | Power mA | Watts |
|-----------|----------------|----------|-------|
| PS24-0.4A | 230/24VDC 0.4A | 0.4A | 9.6W |
| PS24-1A | 230/24VDC 1A | 1A | 24W |
| PS24-2A | 230/24VDC 2A | 2A | 48W |

All Power Supplies supplied with 1 meter cable with 2 Pin female connector

Extension Cables

| | |
|-------|-----------------------------------------------------------------|
| EX-12 | 1 meter 2 core x 0.75mm cable with 1 x male and 1 x female plug |
| EX-22 | 2 meter 2 core x 0.75mm cable with 1 x male and 1 x female plug |
| EX-42 | 4 meter 2 core x 0.75mm cable with 1 x male and 1 x female plug |
| EX-52 | 5 meter 2 core x 0.75mm cable with 1 x male and 1 x female plug |

Power Supplies for Colour Changing Paving Lights (4 wire system). c/w controller

| Code | Description | No. B1 Lights | No. B2 Lights | No. B3, B4 or B5 Lights |
|------------|----------------|---------------|---------------|-----------------------------------------------------------------------------|
| PSC24-0.4A | 230/24VDC 0.4A | 5 | 2 | 1 Power Supplies with push button to stop colour changing at desired colour |
| PSC24-1A | 230/24VDC 1A | 12 | 4 | 2 |
| PSC24-2A | 230/24VDC 2A | 23 | 8 | 4 |

All Power Supplies supplied with 1 meter cable with 4 Pin female connector

Extension Cables

| | |
|-------|-----------------------------------------------------------------|
| EX-14 | 1 meter 4 core x 0.75mm cable with 1 x male and 1 x female plug |
| EX-24 | 2 meter 4 core x 0.75mm cable with 1 x male and 1 x female plug |
| EX-44 | 4 meter 4 core x 0.75mm cable with 1 x male and 1 x female plug |
| EX-54 | 5 meter 4 core x 0.75mm cable with 1 x male and 1 x female plug |

All Power Supplies supplied with 1 meter cable with 4 Pin female connector

Application



| Power Supply | For Colour | Max No of Lights per Power Supply | | | | | | | |
|--------------|---------------|-----------------------------------|----|--------|-----|----|----|----|----|
| | | B1 | B2 | B3, B4 | B5 | B6 | B7 | B8 | B9 |
| 0.4A | R, G, Y, B, W | 20 | 6 | 3 | 20 | 5 | 7 | 6 | 3 |
| | M (RGB) | 6 | 2 | 1 | 7 | 2 | 2 | 2 | 1 |
| 1A | R, G, Y, B, W | 50 | 16 | 8 | 50 | 14 | 18 | 16 | 8 |
| | M (RGB) | 16 | 5 | 3 | 18 | 5 | 6 | 5 | 2 |
| 2A | R, G, Y, B, W | 100 | 33 | 16 | 100 | 28 | 37 | 33 | 16 |
| | M (RGB) | 33 | 11 | 5 | 37 | 9 | 12 | 11 | 5 |

LED FOOTLIGHTS



HHB-WF-01



HHB-WF-01-S

Standard Foot Light IP65 - Input Voltage: 230VAC | Beam Angle: 90° | CRI ≥ 80 | Die Cast Aluminium & Glass | Wall Box Excluded, for wall box see BEL-B1

| Code | Wattage | Lumens | Cut Out | Size (mm) |
|----------------|---------|--------|-----------|-----------|
| HHB-WF-01-**-* | 1.5W | 45lm | 86 x 86mm | 95 x 95mm |

Motion Sensor Foot Light IP65 - Input Voltage: 230VAC | Beam Angle: 90° | CRI ≥ 80 | Sensing Distance: 3m | Sensor Angle: 100° | Time Delay: 3 seconds | Die Cast Aluminium & Glass | Wall Box Exclude, for wall box see BEL-B1

| Code | Wattage | Lumens | Lumens | Size (mm) |
|------------------|---------|--------|-----------|-----------|
| HHB-WF-01-S-**-* | 1.5W | 45lm | 86 x 86mm | 95 x 95mm |

*Add body colour to code: **WH** (White), **BK** (Black), **G** (Gold)

*Add colour to code: ○ **WW** (Warm White - 2700K), ○ **CW** (Cool White - 4000K)

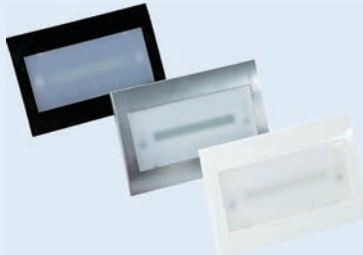

Sensor / Emergency Foot Light IP20 - Easy to Install and fits all 4 x 2 wall boxes (wall box excluded) | Dimensions: 115 x 80 x 28mm

| Code | Wattage | Lumens | Battery | Backup Time | Function |
|--------------|---------|--------|------------------|-------------|----------|
| EMG-FP-NMM-* | 2W | 160lm | 1 x 0.7Ah Li-ion | 3h | nm/m |
| EMG-FP-S-* | 2W | 160lm | - | - | Sensor |

*Add face plate colour to code: ○ **WH** (White), ● **BK** (Black), ● **S** (Silver)



SQ06

Square LED Lights

| Bezel Colour | Code | Size (mm) | Material | IP | Light Output | Power Consumption | LED |
|-----------------|---------------|-------------------|-----------------|-------------|--------------|-------------------|-----|
| Stainless Steel | SQ06-* | 103L x 103W x 63H | Stainless Steel | IP65 | 20W | 1.6W | 30 |

* Add colour to code: ○ **WW** (Warm White), ● **R**, ● **G**, ● **B**.

* Add voltage to code: **12V AC/DC**, **230VAC**. For 12V LED power supply see page 108-110.



RD02

RD04

RD05/6

Round LED Lights with removable bezel

*Can be used underwater

| Bezel Colour | Code | Size (mm) | Material | IP | Light Output | Power Consumption | LED |
|--------------|----------------|------------------------------------------------------------------------------------------------------------------|----------|--------------|--------------|-------------------|-----|
| WH, BK, C | RD02-* | Ø122x53 | Plastic | IP68* | 20W | 1.44W | 30 |
| | RD02B-* | *Bezel colour: W (White), G (Gold), C (Chrome), BK (Black), to be ordered separately | | | | | |

*Add colour to code: ○ **WW** (Warm White), ● **R**, ● **G**, ● **B**.

*Add voltage to code: **12V AC/DC**, **230VAC**. For 12V LED power supply see page 108-110.

RD02 supplied standard with white bezel. Other colour bezel to be ordered separately.

Round LED Lights

| | | | | | | | |
|--------|---------------|----------|-----------|-------------|-----|-------|----|
| White | RD04-* | Ø69x22.5 | Aluminium | IP25 | 11W | 0.9W | 15 |
| Chrome | RD05-* | Ø104x21 | Aluminium | IP44 | 30W | 2.9W | 48 |
| Chrome | RD06-* | Ø93x21 | Aluminium | IP44 | 20W | 1.44W | 30 |

*Add colour to code: ○ **WW** (Warm White), ● **R**, ● **G**, ● **B**.

*Add voltage to code: **12V AC/DC**, **230VAC**. For 12V LED power supply see page 108-110.

LED RECESSED WALL LIGHTS

Supply Voltage: 230VAC

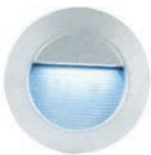

Aluminium

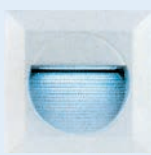

Aluminium



Aluminium



Aluminium



| Code | LED-J01* | LED-J02* | LED-J04* | LED-9009** | WL11027-**-* | WL11028-**-* |
|-----------|-------------------|-------------------|-------------------|-------------|-----------------|-----------------|
| LED's | 14 x 0.08W (1.2W) | 14 x 0.08W (1.2W) | 18 x 0.08W (1.5W) | 2 x 1W | 4W | 4W |
| Lumens | 32lm | 32lm | 36lm | 90lm | 120lm | 120lm |
| IP Rating | IP54 | IP54 | IP54 | IP54 | IP44 | IP44 |
| Size (mm) | Ø126 x 65.5 | 65.5 x 126 x 126 | 138 x 140 x 94 | 132 x 62 | 165 x 125 x 105 | 165 x 125 x 105 |

*Add colour to code: ○ **CW** (Cool White), ○ **WW** (Warm White) *Add colour to code: ○ **CW** (Cool White), ● **R** (Red), ● **GN** (Green), ● **BL** (Blue), ● **Y** (Yellow)

Add colour to code: ○ **CW (Cool White), ○ **WW** (Warm White), ● **BL** (Blue), ● **R** (Red)

LED RECESSED WALL LIGHTS

Supply Voltage: 230VAC



| | | | | | |
|------------------|---------------------------------|----------------------|------------------|------------------|--------------------|
| | <td> <td> NEW</td> </td> | <td> NEW</td> | NEW | | |
| | c/w Wall Box | c/w Wall Box | c/w Wall Box | c/w Wall Box | |
| Code | FG07401-* | FG07501-* | FG07601-* | FG07701-* | RW-OCL-02 |
| Lamp Holder | 1.5W LED | 1.5W LED | 3.5W LED | 3.5W LED | E27 Max. 60W |
| Lumens | 75lm | 55lm | 195lm | 187lm | N/A |
| IP Rating | IP65 | IP65 | IP65 | IP65 | IP44 |
| Size (mm) | 80 x 80 x 61 | 123 x 53 x 61 | 135 x 135 x 65 | 205 x 95 x 65 | 233 x 101 x 83 |
| Material | ST304 + Aluminium | | | | Die Cast Aluminium |

*Add colour to code: ○ CW (Cool White), ○ WW (Warm White)

Supply Voltage: 230VAC



| | | | | | |
|------------------|----------------------|------------------|------------------|------------------|--------------------|
| | <td> <td></td> </td> | <td></td> | | | |
| | c/w Wall Box | c/w Wall Box | c/w Wall Box | c/w Wall Box | |
| Code | FG07402-* | FG07502-* | FG07602-* | FG07702-* | RW-OCL-01 |
| Lamp Holder | 1.5W LED | 1.5W LED | 3.5W LED | 3.5W LED | E27 Max. 60W |
| Lumens | 42lm | 55lm | 136lm | 125lm | N/A |
| IP Rating | IP65 | IP65 | IP65 | IP65 | IP44 |
| Size (mm) | 80 x 80 x 61 | 123 x 53 x 61 | 135 x 135 x 65 | 205 x 95 x 65 | 233 x 101 x 83 |
| Material | ST304 + Aluminium | | | | Die Cast Aluminium |

*Add colour to code: ○ CW (Cool White), ○ WW (Warm White)

Supply Voltage: 12VAC/DC

Surface Mount

| | | | | |
|------------------|-------------------|-------------------|-------------------|------------------|
| | <td> </td> | | | |
| Code | HLH02801-* | HLH02802-* | HLH02804-* | WL11001-* |
| LEDs | 4 x 0.1W (0.4W) | 8 x 0.1W (0.8W) | 12 x 0.09W (1W) | 4 x 0.02 (0.8W) |
| Lumen | 12lm | 24lm | 36lm | 8lm |
| IP Rating | IP67 | IP67 | IP67 | IP20 |
| Size (mm) | Ø70 x 13 | Ø70 x 13 | Ø70 x 13 | Ø45 x 15 |

*Add colour to code: ○ CW (Cool White), ○ WW (Warm White), ● BL (Blue)



LED PLASTIC FOOT LIGHTS IP65

NEW

| | | | | | | |
|-------------|------------------------|------------------------|------------------------|------------------------|------------------------|------------------------|
| | <td> <td> </td></td> | <td> </td> | | | | |
| Code | P-2301-BK-* | P-2302-BK-* | P-1251-H-BK-* | P-1252-BK-* | P-1001-BK-* | PW-2202-A-BK-* |
| LED's | 4W | 3W | 4W | 1.5W | 1.5W | 6W |
| Lumens | 280lm | 190lm | 270lm | 60lm | 80lm | 300lm |
| Size (mm) | 230 x 80 x 27 | 230 x 80 x 27 | 125 x 125 x 37 | 125 x 125 x 37 | 100 x 60 x 33 | 220 x 113 x 51 |
| Colour | Black | Black | Black | Black | Black | Black |
| Material | ABS Body / PC Diffuser | ABS Body / PC Diffuser | ABS Body / PC Diffuser | ABS Body / PC Diffuser | ABS Body / PC Diffuser | ABS Body / PC Diffuser |



*Add colour to code: ○ CW (Cool White) 4000K, ○ WW (Warm White) 3000K.

LED WALL LIGHTS



| | | |
|---------------------------|-----------------------------------------------------------------------------------|-------------------------------------------------------------------------------------|
| Supply Voltage: 230VAC |  |  |
| Code | CIE-L004* | CIE-L010* |
| LED's | 12 x 0.08W (1W) | 16 x 0.06W (0.96W) |
| Lumen | 11lm | 11lm |
| IP Rating | IP44 | IP23 |
| Size (mm) | 190 x 250 x 105 | 156 x 180 x 130 |
| Material | Stainless Steel | Stainless Steel |

*Add LED colour to code: ○ WH (White), ● BL (Blue), ● Y (Yellow), ● GN (Green), ● R (Red)

*Add LED colour to code: ○ W (White), ● BL (Blue), ● Y (Yellow), ● GN (Green), ● R (Red)

| | | |
|---------------------------|-----------------------------------------------------------------------------------|-------------------------------------------------------------------------------------|
| Supply Voltage: 230VAC |  |  |
| Code | CIE-L015* | CIE-L016* |
| LED's | 18 x 0.06W (1.08W) | 18 x 0.06W (1.08W) |
| Lumen | 11lm | 25lm |
| IP Rating | IP44 | IP54 |
| Size (mm) | Ø144 x 40 | Ø145 x 40 |
| Material | Stainless Steel | Stainless Steel |

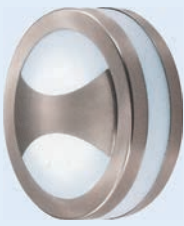
*Add LED colour to code: ○ WH (White), ● BL (Blue), ● Y (Yellow), ● GN (Green), ● R (Red)

| | | | |
|---------------------------|-------------------------------------------------------------------------------------|-------------------------------------------------------------------------------------|---------------------------------------------------------------------------------------|
| Supply Voltage: 230VAC |  |  |  |
| | <i>Cool White only</i> | <i>Cool White only</i> | <i>Cool White only</i> |
| Code | KH252 | KH252-A | KH252-C |
| LED's | 36 x 0.12W (4.32W) | 36 x 0.12W (4.32W) | 36 x 0.12W (4.32W) |
| Lumen | 144lm | 144lm | 144lm |
| IP Rating | IP44 | IP44 | IP44 |
| Size (mm) | Ø140 x 55 | Ø140 x 55 | Ø140 x 55 |
| Material | Stainless Steel | Stainless Steel | Stainless Steel |

Outdoor

| | | | |
|---------------------------|-------------------------------------------------------------------------------------|-------------------------------------------------------------------------------------|---------------------------------------------------------------------------------------|
| Supply Voltage: 230VAC |  |  |  |
| Code | LED-9006* | LED-9003* | LED-9004* |
| LED's | 36 x 0.08W (2.9W) | 36 x 0.08W (2.9W) | 36 x 0.08W (2.9W) |
| Lumen | 70lm | 70lm | 108lm |
| IP Rating | IP54 | IP54 | IP44 |
| Size (mm) | Ø140 x 52 | Ø140 x 52 | Ø140 x 52 |
| Material | Aluminium | Aluminium | Aluminium |

*Add colour to code: ○ CW (Cool White), ● R (Red), ● GN (Green), ● BL (Blue), ● Y (Yellow)

LIGHTING

NEW

LED ABS & PC BULKHEADS IP54

Input Voltage: 230VAC | 90 Lumens p/W | Body Material: ABS | Diffuser: Glass

Input Voltage: 230VAC | 90 Lumens p/W | Body Material: ABS | Diffuser: PC

| | | | | |
|-------------|--------------------|--------------------|------------------------|-------------------------|
| | | | | |
| | 6000K | 6000K | | |
| Code | BL1113-9W-* | BL1112-9W-* | LED-BL1A-C-7W-* | LED-BL1A-C-10W-* |
| Wattage | 9W | 9W | 7W | 10W |
| Lumen | 720lm | 720lm | 630lm | 900lm |
| Size (mm) | Ø185 | Ø185 | Ø170 x 55 | Ø211 x 55 |
| Colour | White | White | White | White |
| | | | | |
| | | | | |
| Code | BL1118-9W-* | BL1117-9W-* | LED-BL1A-O-7W-* | LED-BL1A-O-10W-* |
| Wattage | 9W | 9W | 7W | 10W |
| Lumens | 720lm | 720lm | 630lm | 900lm |
| Size (mm) | 200 x 120 | 200 x 120 | 200 x 100 x 55 | 230 x 105 x 55 |
| Colour | White | White | White | White |

*Add body colour to code: **WH** (White), **BK** (Black) *Add colour to code: ○ **CW** (Cool White) 4000K, ○ **WW** (Warm White) 3000K

LED PLASTIC BULKHEADS

| | | | |
|-----------------|---------------------|--------------------|--------------------|
| IP65 | Clear Prismatic | Opal | Opal |
| | | | |
| Code | CBH-12W-* | OBH-1-12W-* | OBH-2-12W-* |
| Power | 12W | 12W | 12W |
| Size (mm) | Ø270 x 60 | Ø270 x 60 | Ø270 x 115 |
| Material | Plastic | Plastic | Plastic |

* Add Colour to code: ○ **CW** (Cool White) 4000K, ○ **DL** (Day Light) 6000K. For Day-Night Sensor add /DN to code

| | | | | |
|-------------------------------------------------------------------------------------------------------------|-----------------|---------------|---------------------------------------------|---------------|
| ○ CW - 4000K ○ DL - 6000K Supply Voltage: 85-265VAC Material: Plastic IP54 | | | | |
| | | | | |
| Code | LAM12T | LAL010 | LAL020 - * | LAL030 |
| Power | 12W | 12W | 18W | 22W |
| Lumen | 800lm | 800lm | 1600lm | 2400lm |
| Size (mm) | 290 x 290 x 100 | Ø300 x 100 | Ø335 x 118 | Ø400 x 135 |
| Colour | Black | Black | Black | Black |
| Colour Temp | DL | DL | * Add Colour to code: CW / DL | DL |

| | | | |
|-------------------------------------------------------------------------------------------------------------|-----------------|-----------------|-----------------|
| ○ CW - 4000K ○ DL - 6000K Supply Voltage: 85-265VAC Material: Plastic IP54 | | | |
| | | | |
| Code | LAL10E | LAL06E | LAL07E |
| Power | 10W | 6W | 7W |
| Lumen | 550lm | 270lm | 260lm |
| Size (mm) | 290 x 200 x 100 | 290 x 200 x 100 | 290 x 200 x 100 |
| Colour | Black | Black | Black |
| Colour Temp | DL | DL | DL |

LED PLASTIC BULKHEADS

Supply Voltage: 220-240VAC | Material: Plastic

|  Optional | Available in Black and White | | | |
|-----------------------------------------------------------------------------------------------|-----------------------------------------------------------------------------------|---------------------------------------------------------------------------------------------------------------------------------------------------------------------------------------------------------------------------|------------------------------------------------------------------------------------|-------------------------------------------------------------------------------------|
| |  | Day/night sensor non-adjustable, ambient <25lux   |  |  |
| Code Standard | BL220-12W-*-* | BL220-12W-PIR-*-* | BL270-20W-* | BL320-24W-* |
| Code Day/Night | BL220-12W-*-*-DN | - | - | - |
| Wattage | 12W | 12W | 20W | 24W |
| Lumens | 840lm | 840lm | 1500lm | 1800lm |
| IP Rating | IP54 | IP54 | IP65 | IP65 |
| Size (mm) | Ø220 x 99 | Ø220 x 99 | Ø270 X 102 | Ø320 x 113 |
| Colour | White / Black | White / Black | White | White |





|  Optional |  |  |  |  |  |
|-----------------------------------------------------------------------------------------------|-----------------------------------------------------------------------------------|-----------------------------------------------------------------------------------|-----------------------------------------------------------------------------------|-------------------------------------------------------------------------------------|-------------------------------------------------------------------------------------|
| | Code Standard | UP-AL55-15W-* | LG09A-300-17-* | CL280-CP02-18W-* | CL330-CP02-24W-* |
| Code Day/Night | UP-AL55-15W-*-*-DN | LG09A-300-17-*-*-DN | CL280-CP02-18W-*-*-DN | - | - |
| Wattage | 15W | 17W | 18W | 24W | 18W |
| Lumen | 1500lm | 1300lm | 1440lm | 1920lm | 1440lm |
| IP Rating | IP65 | IP54 | IP44 | IP44 | IP44 |
| Size (mm) | Ø300 x 60 | Ø305 X 84 | Ø280 x 60 | Ø330 x 60 | 280 x 280 x 60 |
| Colour | White | White | White | White | White |

*Add colour to code: ○ CW (Cool White) 4000K, ○ DL (Day Light) 6000K *Add trim colour to code: ● BK (Black), ○ WH (White)

RECTANGULAR BULKHEADS

| Lamps excluded. For Lamps see Page 6 |  |  |  |  |  |
|-----------------------------------------|-------------------------------------------------------------------------------------|-------------------------------------------------------------------------------------|-------------------------------------------------------------------------------------|---------------------------------------------------------------------------------------|---------------------------------------------------------------------------------------|
| | Code | BH-01 | NB2047-B | BK6001 | BK6003 |
| Lamp/Watts | B22/60W | E27/100W | E27 | E27 | E27 |
| IP Rating | IP44 | IP54 | IP54 | IP54 | IP65 |
| Size (mm) | 220 x 105 x 105 | 245 x 120 x 115 | 250 x 175 x 116 | 280 x 175 x 133 | 330 x 230 x 190 |
| Material | Plastic | Die-cast Al / Plastic | Plastic | Aluminium / Plastic | Aluminium / Glass |

PLASTIC BULKHEAD IP54

| Lamps Excluded | Plastic Opal | Clear Diffused Plastic | Plastic Opal | Clear Plastic | |
|----------------|--------------------------------------------------------------------------------------------------------------------------------------------------------------------------------------------------------------------------------------------------------------------------------------------------------------------------|-------------------------------------------------------------------------------------|-------------------------------------------------------------------------------------|---------------------------------------------------------------------------------------|---------------------------------------------------------------------------------------|
| |  |  |  |  |  |
| Code | WH1039-* | WH1040-* | BK1039-2D | BK1040-2D | CL1132 |
| Size (mm) | 270Ø x 70 | | | 270Ø x 70 | |
| Lamp | *Add type of lamp to code: 2D (2D16W), 2PL9 (2 x 9PL), E27 (E27 lamp holder), 2D-MS (with microwave motion sensor), 2PL9-MS (with microwave motion sensor built into the fitting). These very sensitive sensors work on the same principle as radar. See page 18-19, 6 for more info. | | | • Black only available in 2D lamp 2D-16-4P | |
| | | | | Glass Lens and ABS base | |
| | | | | 270 x 155 x 110 E27(CFL/LED) | |

Note: All fittings on this page that use 2D lamps use the 4-pin lamp, eg. 2D-16-4P-CW

Outdoor

LIGHTING

LED OUTDOOR BULKHEADS IP65

Supply Voltage: 85-265VAC | Colour Temp: 6000K

| | | | | |
|------------------------|---------------------|---------------------|---------------------|----------------------|
| Supply Voltage: 230VAC | | | | |
| Code | CL3808-LED | XDF32185-15W | XDY32185-15W | XDY339125-13W |
| Power | 15W | 15W | 15W | 13W |
| Lumen | 1300lm | 1200lm | 1200lm | 1200lm |
| Size (mm) | Ø325 x 100 | 250 x 250 x 90 | Ø350 x 85 | 300 x 100 x 85 |
| Material | PC Cover & ABS Base | PC Cover & ABS Base | PC Cover & ABS Base | PC Cover & ABS Base |

PLASTIC BULKHEADS IP65

| | | | |
|----------------|-----------------------|-----------------------|-----------------------|
| Lamps excluded | | | |
| Code | CL3873 | CL3869 | CL3819 |
| Lamp | 2D-28-4P | 2D-28-4P | 2D-28-4P |
| Size (mm) | Ø316 x 125H | Ø280 x 86H | 280 x 280 x 87 |
| Material | PC cover and ABS base | PC cover and ABS base | PC cover and ABS base |

2D PLASTIC BULKHEADS

| | | | | | |
|------------------|-------------------------------|-----------------------|-----------------------|-----------------|------------------|
| Lamps excluded | | | | | |
| Code | CL3870 | CL3808B | CL2153 | | |
| Lamp | 2D-28-4P | 2D-28-4P | 2D-16-4P | | |
| IP Rating | IP65 | IP65 | IP54 | | |
| Size (mm) | Ø330 x 99 | Ø325 x 100 | Ø257 x 73 | | |
| Material | PC cover and ABS base | PC cover and ABS base | PC cover and ABS base | | |
| Lamps Excluded | Chrome Trim | Gold Trim | | | |
| Code | CL10021-CH | CL10021-G | CL10022 | | |
| Lamp | 2D-16-4P | 2D-16-4P | 2D-28-4P | | |
| Size (mm) | Ø270 x 90 | Ø270 x 90 | Ø320 x 90 | | |
| Material | PC cover ABS base IP54 | | | | |
| Lamps Excluded | | | | | |
| Code | CL10001 | CL10002 | CL10003 | CL10010 | CL10018-1 |
| Lamp | 2 x PLCE-18 | 2D-28-4P | 2D-28-4P | 2D-16-4P | 2D-28-4P |
| Size (mm) | 340Ø x 115H | 300Ø x 102H | 302L x 302W x 93H | 305Ø x 68H | 305Ø x 80H |
| Material | PC cover ABS base IP54 | | | | |

Outdoor

LIGHTING

LED DIE-CAST ALUMINIUM BULKHEADS IP54

Input Voltage: 220-240VAC | Body Material: Die-cast Aluminium | Diffuser: Glass | Colour Temp: 6000K | Driver on board (DOB)

| | | | | |
|-------------------|---------------------|----------------------|---------------------|----------------------|
| | | | | |
| Code White | BL1112-6W-WH | BL1112-12W-WH | BL1113-6W-WH | BL1113-12W-WH |
| Code Black | BL1112-6W-BK | BL1112-12W-BK | BL1113-6W-BK | BL1113-12W-BK |
| Wattage | 6W | 12W | 6W | 12W |
| Lumens | 420lm | 840lm | 420lm | 840lm |
| Size (mm) | Ø192 | Ø240 | Ø192 | Ø240 |
| | | | | |
| Code White | BL1115-6W-WH | BL1115-12W-WH | BL1117-6W-WH | BL1117-12W-WH |
| Code Black | BL1115-6W-BK | BL1115-12W-BK | BL1117-6W-BK | BL1117-12W-BK |
| Wattage | 6W | 12W | 6W | 12W |
| Lumens | 420lm | 840lm | 420lm | 840lm |
| Size (mm) | Ø192 | Ø240 | 213 x 95 x 107 | 283 x 162 x 140 |
| | | | | |
| Code White | BL1118-6W-WH | BL1118-12W-WH | BL1119-6W-WH | BL1119-12W-WH |
| Code Black | BL1118-6W-BK | BL1118-12W-BK | BL1119-6W-BK | BL1119-12W-BK |
| Wattage | 6W | 12W | 6W | 12W |
| Lumens | 420lm | 840lm | 420lm | 840lm |
| Size (mm) | 213 x 95 x 107 | 283 x 162 x 140 | 213 x 95 x 107 | 283 x 162 x 140 |

BULKHEADS - INDOORS & OUTDOORS IP54

Outdoor

| | | | | | |
|-----------------------------------|-----------------------|-----------------------|----------------------------|-----------------------|--|
| Lamp Type: E27. Lamps Excluded | | | | | |
| Code (White) | NB304001 | NB304003 | NB1004L-E27 | NB304004 | |
| Code (Black) | NB304001-B | NB304003-B | NB1004L-E27-B | - | |
| Code G24D | NB2026 (2x13W) | NB2024 (2x13W) | NB1004L-G24 (2x13W) | NB2025 (1x13W) | |
| Lamp | PLC-13 | PLCE-13 | PLC-13 | PLCE-13 | |
| Size (mm) | 240Ø x 110 | 240Ø x 105 | 240Ø x 128 | 240Ø x 125 | |
| Material | Die-Cast Aluminium | Die-Cast Aluminium | Die-Cast Aluminium | Die-Cast Aluminium | |

LIGHTING

| | | | | | | |
|-----------------------------------|-----------------------|-----------------------|---------------------------|--------------------|--------------------|--------------------|
| Lamp Type: E27. Lamps Excluded | | | | | | |
| Code (White) | NB304005-W | NB304007 | NB1014L-E27 | - | - | - |
| Code (Black) | NB304005-B | - | - | NB2044 | NB2016-S | NB2019-S |
| Code G24D | NB2031 (1x13W) | NB2030 (1x13W) | NB1014-G24 (1x13W) | - | - | - |
| Power | 1 x 13W | 1 x 13W | 1 x 13W | 1 x 13W | 1 x 13W | 1 x 13W |
| Lamp | PLCE-13 | PLC-13 | PLC-13 | PLCE-13 | PLCE-13 | PLCE-13 |
| Size (mm) | 285 x 160 x 130 | 285 x 160 x 125 | 212 x 95 x 107 | 282 x 182 x 110 | 210 x 145 x 100 | 210 x 145 x 100 |
| Material | Die-Cast Aluminium | Die-Cast Aluminium | Die-Cast Aluminium | Die-Cast Aluminium | Die-Cast Aluminium | Die-Cast Aluminium |

BULKHEADS - INDOORS & OUTDOORS IP54

| | | | | |
|---------------------|--------------------|--------------------|--------------------|--------------------|
| Lamps Excluded | | | | |
| Code (White) | NB2033 | NB2040A | - | NB44-227-WH |
| Code (Black) | NB2033-BK | NB2040A-BK | NB2035 | NB44-227-BK |
| Power | 1 x 13W | 1 x 13W | 1 x 13W | 2 x 14W Max. |
| Lamp | PLC-13 | PLC-13 | PLC-13 | 2 x E27 |
| Size (mm) | Ø235 x 120 | Ø270 x 90 | Ø235 x 120 | Ø280 |
| Material | Die-Cast Aluminium | Die-Cast Aluminium | Die-Cast Aluminium | Die-Cast Aluminium |
| Lamps excluded | | | | |
| Code | MAT-2-ES-C* | MAT-2-ES-O* | MAT-3-ES-O* | |
| Power | 1 x 60W (Max.) | 1 x 60W (Max.) | 1 x 60W (Max.) | |
| Lamp Holder | E27 | E27 | E27 | |
| Size (mm) | Ø270 x 60 | Ø270 x 60 | Ø270 x 115 | |
| Material | Plastic | Plastic | Plastic | |

* For Day-Night Sensor add **DN** to code

E27 DECORATIVE BULKHEADS IP54

| | | | | |
|------------------|-------------------------|-------------------------|-------------------------|--------------------|
| Lamps excluded | | | | |
| Code | NS-1851 | NS-1852 | NS-1853 | NS-1854 |
| Power | 60W Max. | 60W Max. | 60W Max. | 60W Max. |
| Lamp Holder | 2 x E27 | 2 x E27 | 2 x E27 | 2 x E27 |
| Size (mm) | 300 x 350 x 120 | 300 x 350 x 120 | 300 x 350 x 120 | 300 x 350 x 120 |
| Material | Die-Cast Aluminium | Die-Cast Aluminium | Die-Cast Aluminium | Die-Cast Aluminium |
| Lamps excluded | | | | |
| Code | NS-1855 | NS-1928A | NS-1928B | |
| Power | 60W Max. | 60W Max. | 60W Max. | |
| Lamp Holder | 2 x E27 | 1 x E27 | 1 x E27 | |
| Size (mm) | 300 x 350 x 120 | 247 x 252 x 110 | 247 x 252 x 110 | |
| Material | Die-Cast Aluminium | Die-Cast Aluminium | Die-Cast Aluminium | |
| Lamps excluded | | | | |
| Code | C300-006 | KH554 | KH553 | |
| Power | 60W/CFL | 60W Max | 100W max | |
| Lamp Holder | E27 | E27 | E27 | |
| IP Rating | IP54 | IP54 | IP54 | |
| Size (mm) | Ø270 x 100 | Ø190 x 100 | Ø250 x 100 | |
| Material | Stainless Steel / Glass | Stainless Steel / Glass | Stainless Steel / Glass | |

Outdoor

LIGHTING

LED DECORATIVE BULKHEADS IP54

Input Voltage: 95-240VAC | 90 Lumens p/w | Body Material: Die-cast Aluminium | Diffuser: PC | Colour Temp: 6000K

| | | | |
|------------------|-----------------|-----------------|-----------------|
| | | | |
| Code | LB-1927A | LB-1927B | LB-1927C |
| Wattage | 10W | 10W | 10W |
| Size (mm) | 290 x 180 x 90 | 290 x 180 x 90 | 290 x 180 x 90 |
| | | | |
| Code | LB-1932A | LB-1932B | LB-1932C |
| Wattage | 20W | 20W | 20W |
| Size (mm) | Ø280 x 95 | Ø280 x 95 | Ø280 x 95 |
| | | | |
| Code | LB-1801L | LB-1802L | LB-1803L |
| Wattage | 20W | 20W | 20W |
| Size (mm) | 270 x 270 x 80 | 270 x 270 x 80 | 270 x 270 x 80 |

Outdoor

| DALI Dimmable | | | | | | |
|------------------|------------------|------------------|------------------|----------------|-----------------|------------------|
| | | | | | | |
| Code | LB-1802LB | LB-1803LB | LB-1804LB | LB-1842 | LB-1844 | LB-1841-* |
| Wattage | 20W | 20W | 20W | 20W | 20W | 20W |
| Size (mm) | 270 x 270 x 135 | 270 x 270 x 135 | 270 x 270 x 135 | Ø300 x 100 | 300 x 300 x 100 | Ø300 x 100 |

* Add DALI to Code

WALL LIGHTS IP44

Input Voltage: 230VAC



| | | | | | |
|------------------|-------------------|-------------------|-------------------|-------------------|-------------------|
| Code | TL-S-TY02A | TL-S-TY02B | TL-S-TY02C | TL-S-TY02D | TL-S-TY02E |
| Wattage | 7W | 7W | 7W | 7W | 7W |
| Lumens | 350lm | 350lm | 350lm | 350lm | 350lm |
| Size (mm) | 194 x 232 x 162 | 194 x 232 x 162 | Ø162 x 280 | Ø162 x 825 | Ø162 x 1100 |

2 Year warranty on all LED products & 1 Year warranty on all products that carry batteries, unless otherwise specified. Warranty void if adequate surge protection is not installed on LED products. See page 149

©ACDC Dynamics

OUTDOOR WALL LIGHTS

| Solar Wall Light IP44 | | | | Solar Pillar Light IP44 | | | | |
|--------------------------------------------------------------------------------------------------------------|--------------------|--------------------|--------------------|-------------------------|--------------------------------|-------------------------------------------|-------------------------------------|------------------------------------------------------------|
| SOLAR SOL2 • 6-8 Hrs Normal Brightness • Alu. Body & Glass Lamp • Auto Turn On/Off Dusk/Dawn | | | | | | | Auto on/off PMMA Shade | |
| | Code | JY-0012-A | JY-0007-A | JY-0008-A | JY-0012-B | JY-0007-B | JY-0008-B | GD-B-250-S1-S |
| | Wattage | 2.4W | 3W | 4W | 2.4W | 3W | 4W | 1.5W |
| | Lumens | 220lm | 130lm | 220lm | 130lm | 220lm | 220lm | 150lm |
| Size | Ø220 x 530 | Ø260 x 400 | Ø280 x 360 | Ø220 x 550 | Ø260 x 430 | Ø280 x 390 | Ø250x321 | |
| Supply Voltage: 230VAC | Green/Black | Black | c/w Chain | | Timer: 6s - 12m Sensor: 12m | Timer: 6s - 12m Sensor: 10m/180° | Timer: 6s - 12m Sensor: 10m/180° | Supply Voltage: 230VAC Glass Diffuser Lamps Excluded |
| Lamps Excluded | | | | | | | | |
| Code | F3225-B/G | F3225 | LH-5004H | F3125 | F4025 | F4034 | F4034-2 | TL-W-03A |
| Power | 60W | 60W | 100W | 60W | 60W | 1 x 150W | 2 x 150W | 60W Max. |
| Lamp Holder | E27 | E27 | E27 | E27 | E27 | E27 | E27 | E27 |
| IP Rating | IP33 | IP44 | IP33 | IP44 | IP33 | IP33 | IP33 | IP54 |
| Size (mm) | 405 x 203 | 442 x 195 | 1025 x 225 | 346H x 176W | 406H x 232W | 115 x 160 x 115 | 270 x 220 x 115 | 250 x 260 x 420 |
| Material | Die-Cast Aluminium | Die-Cast Aluminium | Die-Cast Aluminium | Die-Cast Aluminium | Die-Cast Aluminium | Die-Cast Aluminium | Die-Cast Aluminium | Stainless Steel |
| Supply Voltage: 230VAC | | | | Green/Black | Black | | | |
| Lamps Excluded | | | | | | | | |
| Code | SS-13014 | LH-5029H | LH-5029D | F3025-B/G | F3025 | LH-5004D | NY1022-* | |
| Power | 75W | 100W | 60W | 60W | 60W | 100W | 100W | |
| Lamp Holder | E27 | E27 | E27 | E27 | E27 | E27 | E27 | |
| IP Rating | IP33 | IP44 | IP33 | IP33 | IP44 | IP33 | IP33 | |
| Size (mm) | 250D x 235H | 875 x 245 | 475 x 395 | 346 x 176 | 346 x 176 | 410 x 260 | 212 x 336 | |
| Material | Die-Cast Aluminium | Die-Cast Aluminium | Die-Cast Aluminium | Die-Cast Aluminium | Die-Cast Aluminium | Die-Cast Aluminium | Die-Cast Aluminium | |
| Supply Voltage: 230VAC | | | | | | Timer: 20s-8min Sensor: 12m Plastic | c/w built-in daylight switch | |
| Lamps Excluded | | | | | | | | |
| Code | NY1592B | NY1001L-* | YF-B5359 | YF-B5352 | YF-B5319 | F4018 | JQ703 | |
| Power | 100W | 100W | 60W | 60W | 60W | 100W | 26W | |
| Lamp Holder | E27 | E27 | E27 | E27 | E27 | E27 | E27 | |
| IP Rating | IP33 | IP33 | IP33 | IP33 | IP33 | IP33 | IP33 | |
| Size (mm) | 245 x 310 | 285 x 470 | 350 x 165 | 285 x 155 | Ø230 | 210 x 260 | Ø230 | |
| Material | Die-Cast Aluminium | Die-Cast Aluminium | Die-Cast Aluminium | Die-Cast Aluminium | Die-Cast Aluminium | Die-Cast Aluminium | Die-Cast Aluminium | |

*Add colour of fitting to code: **GR** (Grey), **BK** (Black) *Add colour of fitting to code: **GR** (Grey), **B/G** (Black and Green)

PMMA LAMP SHADES BAYONET NECK

Lamp shades c/w galleries. Not to be used with Screw-in galleries



| | | | | |
|----------|--------------|---------------|---------------|-----------------|
| Code 8" | GD01-B-200-O | GD01-B-200-CL | GD01-B-200-SY | GD01-B-200-CP |
| Code 10" | GD01-B-250-O | GD01-B-250-CL | GD01-B-250-SY | GD01-B-250-CP |
| Colour | Opal | Clear | Smoky | Clear Prismatic |



| | | | | | | |
|--------|---------|----------|----------|----------|----------|-----------------|
| Code | GD011-O | GD011-CL | GD011-GD | GD012-CL | GD012-GD | GD012-CP |
| Colour | Opal | Clear | Gold | Clear | Gold | Clear Prismatic |

ACCESSORIES FOR BAYONET NECK

Application



H



Short Stand / Long Stand

| Code | Description | Material | Dimensions (mm) |
|-----------|-------------|----------|-------------------------------|
| GDB-PL-* | Pole | PVC | Ø60 x 0.5m / 1m / 1.5m / 1.8m |
| GDB-PB170 | Pole Base | ABS | Ø160 x 170 |

*Add length to code: 0.5M, 1M, 1.5M, 1.8M

Application



Short / Long Stand

| Code | A (mm) | B (mm) | For Sphere with Bayonet Neck (mm) |
|------------|--------|--------|-----------------------------------|
| GDB-SS-120 | 120 | Ø60 | Maximum Ø200 |
| GDB-LS-160 | 160 | Ø60 | Maximum Ø250 |

Application

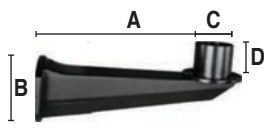

Short / Long Arm Wall Mount

| Code | A (mm) | B (mm) | C (mm) | D (mm) | For Sphere with Bayonet Neck (mm) |
|------------|--------|--------|--------|--------|-----------------------------------|
| GDB-SA-190 | 190 | 100 | 60 | 32 | Maximum Ø250 |
| GDB-LA-310 | 310 | 100 | 60 | 47 | Maximum Ø250 |

Application

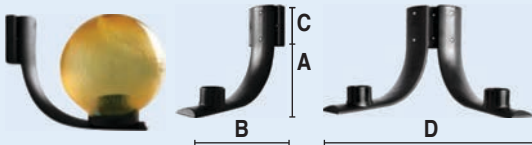

Single / Double Elbow Wall Mount

| Code | A (mm) | B (mm) | C (mm) | D (mm) | For Sphere with Bayonet Neck (mm) |
|-------|--------|--------|--------|--------|-----------------------------------|
| GDB-S | 270 | 270 | 125 | / | Maximum Ø250 |

Application

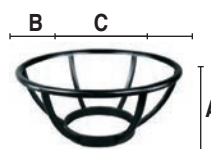

Basket

| Code | A (mm) | B (mm) | C (mm) | For Sphere with Bayonet Neck (mm) |
|----------|--------|--------|--------|-----------------------------------|
| GDB-B122 | 122 | 290 | 160 | Ø250 |

Application



Reflector

| Code | A (mm) | B (mm) | C (mm) | D (mm) | Flats | Material | For Sphere with Bayonet Neck (mm) |
|----------|--------|--------|--------|--------|-------|----------|-----------------------------------|
| GDB-R168 | 168 | 48 | 85 | 50 | 3 | Iron | Maximum Ø200 |
| GDB-R190 | 190 | 69 | 103 | 68 | 4 | Iron | Maximum Ø250 |

Outdoor

LIGHTING

OUTDOOR WALL LIGHTS

| | | | | |
|------------------------|------------------|-----------------------|-------|---------------------|
| Supply Voltage: 230VAC | | | | |
| Lamps Excluded | | | Clear | Red |
| Code | RW-360D-* | X1000C (Clear) | | X1000R (Red) |
| Power | 9W (900lm) | 25W | | 25W |
| Lamp Holder | LED | G9 | | G9 |
| IP Rating | IP65 | IP55 | | IP55 |
| Size (mm) | 110 x 120 x 45 | Ø90 x 85 | | Ø90 x 85 |

*Add colour to code: ○ CW (Cool White - 4000K), ○ WW (Warm White - 2700K)

| | | | | | | |
|------------------|--------------------|--------------------|--------------------|--------------------|--------------------|----------------------|
| Lamps excluded | | | | | | |
| | E27 | E27 | E27 | 4200K | 4200K | 4200K |
| Code | YSC-2002 | YSC-2004 | YSC-2003 | KH820-ADN | KH820-CDN | KH836WU-STONE |
| Wattage | 60W Max | 60W Max | 60W Max | 16 x 0.12W (1.92W) | 16 x 0.12W (1.92W) | 24 x 0.12W (2.88W) |
| Lumen | - | - | - | 51.2lm | 51.2lm | 76.8lm |
| IP Rating | IP44 | IP44 | IP44 | IP44 | IP44 | IP44 |
| Size (mm) | 230 x 260 x 90 | 230 x 260 x 90 | 230 x 260 x 90 | 112 x 90 | 139 x 90 | Ø76 x 220 |
| Material | Die Cast Aluminium | Die Cast Aluminium | Die Cast Aluminium | Stainless Steel | Stainless Steel | Stainless Steel |
| Colour | Black | Grey | Oxidized | Silver | Silver | White Stone |

| | | | | | | | | |
|------------------------|------------------|------------------|------------------|------------------|--------------------|--------------------|---------------------|--------------------|
| Supply Voltage: 230VAC | | | | | | | | |
| LED | | | | | | | | |
| ○ CW - 4200K | | | | | | | | |
| Code | TL-ST-05B | TL-ST-06B | TL-ST-05A | TL-ST-06A | KH838WU | KH838AWU | KH834-SAWU-W | KH834-AWU-W |
| Wattage | 6W | 2 x 6W | 6W | 2 x 6W | 16 x 0.12W (1.92W) | 16 x 0.12W (1.92W) | 16 x 0.12W (1.92W) | 16 x 0.12W (1.92W) |
| Lumen | 300lm | 550lm | 300lm | 550lm | 51.2lm | 51.2lm | 28.8lm | 51.2lm |
| IP Rating | IP44 | IP44 | IP44 | IP44 | IP44 | IP44 | IP44 | IP44 |
| Size (mm) | Ø76 x 220 x 115 | Ø76 x 200 x 115 | Ø76 x 280 | Ø76 x 340 | Ø10 x 235 | Ø101 x 150 x 167 | Ø50 x 109 x 198 | Ø78 x 142 x 235 |
| Material | Stainless Steel | Stainless Steel | Stainless Steel | Stainless Steel | Stainless Steel | Stainless Steel | Stainless Steel | Stainless Steel |
| Colour Temp | Cool White | Cool White | Cool White | Cool White | Cool White | Cool White | Cool White | Cool White |

| | | | | | | |
|------------------------|--------------------|--------------------|--------------------|--------------------|--------------------|--------------------|
| Supply Voltage: 230VAC | | | | | | |
| Colour Temp.: 4000K | | | | | | |
| Dark Grey | | | | | | |
| Code | YSC-2034 | YSC-2013 | YSC-2011 | YSC-2017 | LD3001-56 | NY1836 |
| Wattage | 5W | 5W | 5W | 5W | 50W | 100W |
| Lumen | 500lm | 500lm | 500lm | 500lm | - | - |
| IP Rating | IP54 | IP54 | IP54 | IP54 | IP44 | IP54 |
| Size (mm) | 76 x 106 x 65 | 50 x 120 x 180 | 60 x 242 x 122 | 100 x 195 x 164 | 150 x 380 | 84 x 240 |
| Material | Die Cast Aluminium | Die Cast Aluminium | Die Cast Aluminium | Die Cast Aluminium | Die Cast Aluminium | Die Cast Aluminium |

| | | | | | | |
|------------------|-------------------------|-----------------------|-----------------------|-----------------------|--------------|---------------|
| NEW | | | | | | |
| LED | | | | | | |
| | | | | | 4000K | 4000K |
| Code | LBD-2360-A-12* | LBD-2360-B-12* | LBD-2460-A-12* | LBD-2460-B-12* | B2365 | B2366 |
| Wattage | 12W | 12W | 12W | 12W | 2 x 5W | 2 x 5W |
| Lumens | 1200lm | 1200lm | 1200lm | 1200lm | 2 x 500lm | 2 x 500lm |
| IP Rating | IP54 | IP54 | IP54 | IP54 | IP54 | IP54 |
| Size | Ø170 x 100 | Ø170 x 100 | 160 x 160 x 100 | 160 x 160 x 100 | Ø97 x 134 | 97 x 97 x 134 |
| Material | Die-Cast Aluminium / PC | | | | | |

| | | | | | | |
|------------------|--------------------|--------------------|--------------------|--------------------|--------------------|--------------------|
| LED | | | | | | |
| | | | | | | |
| | | | | | | |
| Code | YSC-2034 | YSC-2013 | YSC-2011 | YSC-2017 | LD3001-56 | NY1836 |
| Wattage | 5W | 5W | 5W | 5W | 50W | 100W |
| Lumen | 500lm | 500lm | 500lm | 500lm | - | - |
| IP Rating | IP54 | IP54 | IP54 | IP54 | IP44 | IP54 |
| Size (mm) | 76 x 106 x 65 | 50 x 120 x 180 | 60 x 242 x 122 | 100 x 195 x 164 | 150 x 380 | 84 x 240 |
| Material | Die Cast Aluminium | Die Cast Aluminium | Die Cast Aluminium | Die Cast Aluminium | Die Cast Aluminium | Die Cast Aluminium |

| | | | | | | |
|------------------|--------------------|--------------------|--------------------|--------------------|--------------------|--------------------|
| LED | | | | | | |
| | | | | | | |
| | | | | | | |
| Code | YSC-2034 | YSC-2013 | YSC-2011 | YSC-2017 | LD3001-56 | NY1836 |
| Wattage | 5W | 5W | 5W | 5W | 50W | 100W |
| Lumen | 500lm | 500lm | 500lm | 500lm | - | - |
| IP Rating | IP54 | IP54 | IP54 | IP54 | IP44 | IP54 |
| Size (mm) | 76 x 106 x 65 | 50 x 120 x 180 | 60 x 242 x 122 | 100 x 195 x 164 | 150 x 380 | 84 x 240 |
| Material | Die Cast Aluminium | Die Cast Aluminium | Die Cast Aluminium | Die Cast Aluminium | Die Cast Aluminium | Die Cast Aluminium |

*Add colour to code: ○ CW (Clear White), ○ WW (Warm White)

OUTDOOR WALL LIGHTS

| | | | | | | |
|----------------------------------------------------------------------------------|------------------------------|------------------------------|---------------------------|-----------------|------------------|-----------------------------------|
| Supply Voltage: 230VAC Lamps Excluded S/Steel + PS | | | | | | |
| Code | HC-26402 | HC26902 | HC-27302 | HC-24401 | HC-24801 | HC-23301 |
| Power | 10W | 20W | Max 20W | Max 20W | Max 20W | Max 20W |
| Lamp Holder | E14 | E27 | E27 | E27 | E27 | E27 |
| IP Rating | IP54 | IP54 | IP54 | IP54 | IP54 | IP54 |
| Size (mm) | 130 x 240 x 170 | 130 x 240 x 170 | 224 x 240 x 176 | 170 x 220 x 210 | 220 x 285 x 270 | 250 x 320 x 220 |
| Supply Voltage: 230VAC Lamps Excluded | Die-Cast Aluminium Black | Die-Cast Aluminium Black | With day/night sensor | | | |
| Code | AB-1001-BK | AB-2002-BK | CIE008S | CIE018 | CIE053-G* | CIE052-G |
| Power | 10W LED Max. | 2 x 10W LED Max. | 60W/CFL | 60W/CFL | 2 x 25W | 1 x 25W |
| Lamp Holder | E27 | 2 x E27 | E27 | E27 | G9 / E27 | G9 / E27 |
| IP Rating | IP33 | IP33 | IP44 | IP44 | IP44 | IP44 |
| Size (mm) | 158 x 250 x 110 | 95 x 355 x 100 | Ø60 x 430 | Ø76 x 390 | Ø63 x 250 | Ø104 x 120 |
| *Add Lamp Holder Type to code: G9, E27 | | | | | | |
| Supply Voltage: 230VAC Lamps Excluded | | | | | | With day/night sensor |
| Code | CIE019 | CIE015 | C300-008 | CIE013-A | C300-223 | CIE007S |
| Power | 60W/CFL | 60W/CFL | 60W/CFL | 60W/CFL | 100W/CFL | 60W/CFL |
| Lamp Holder | E27 | E27 | E27 | E27 | E27 | E27 |
| IP Rating | IP44 | IP44 | IP44 | IP44 | IP44 | IP44 |
| Size (mm) | Ø120 x 390 | Ø120 x 395 | 260 x 220 x 90 | 250 x 300 | Ø250 x 380 x 410 | Ø200 x 250 x 345 |
| Supply Voltage: 230VAC Lamps Excluded | | | | | | S/Steel body & glass diffuser |
| Code | KH147-WU | KH148WU+SEN | KH148WU | C300-110 | C300-203 | KH177AWU |
| Power | 50W max | 50W max | 50W | 60W/CFL | 60W/CFL | 60W/ CFL |
| Lamp Holder | GU10 | GU10 | GU10 | E27 | E27 | E27 |
| IP Rating | IP44 | IP44 | IP44 | IP44 | IP44 | IP44 |
| Size (mm) | 195 x 240 | 200 x 260 | 200 x 225 | 260 x 235 | 225 x 276 | Ø128 x 480 |
| Supply Voltage: 230VAC Lamps Excluded S/Steel & Alum body with PC diffuser | | | | | | |
| Code | KH715-BK | KH715 | KH715WU-BK | KH715WU | KH246E | |
| Power | 60W | 60W | 60W | 60W | 60W | |
| Lamp Holder | E27 | E27 | E27 | E27 | E27 | |
| IP Rating | IP44 | IP44 | IP44 | IP44 | IP44 | |
| Size (mm) | 235 x 445 | 235 x 445 | 175 x 345 | 175 x 345 | 345 x 100 | |

Outdoor

LIGHTING

UP / DOWN LIGHTS

| | | | | |
|--------------------------------------------------------------------------------|------------------------------------------------------------------------------------------------------------------------------------------------------------|------------------------------------------------------------------|--|------------------------------------------------------------------|
| Supply Voltage: 230VAC *Add colour to code: ○ WW - 2700K ○ CW - 4200K | <table border="1"> <tr> <td>Supply Voltage: 230VAC</td> <td></td> <td> <p>*Add colour to code: ○ CW (Cool White), ○ WW (Warm White)</p> </td></tr></table> | Supply Voltage: 230VAC | | <p>*Add colour to code: ○ CW (Cool White), ○ WW (Warm White)</p> |
| Supply Voltage: 230VAC | | <p>*Add colour to code: ○ CW (Cool White), ○ WW (Warm White)</p> | | |

| |
|--------------------------------------------------------------------------------------------------|
| <p>*Add LED colour to code: ○ WH (White), ● BL (Blue), ● Y (Yellow), ● GN (Green), ● R (Red)</p> |
|--------------------------------------------------------------------------------------------------|

| | | | | |
|------------------------|-----------------|-----------------|-------------------|-------------------|
| Supply Voltage: 230VAC | | | Plastic | Plastic |
| Lamps Excluded | | | | |
| Code | YF-B5475 | DH28330 | P1602-GU10 | P1600-GU10 |
| Power | 2 x 60W | 2 x 60W | Max 1 x 6W | Max 2 x 6W |
| Lamp Holder | E27 | E27 | GU10 | 2 x GU10 |
| IP Rating | IP44 | IP44 | IP44 | IP44 |
| Size (mm) | 90Ø x 260 | 118 x 181 x 400 | 87 x 60 x 120 | 87 x 60 x 158 |





| | | | | | |
|------------------------|-----------------|-----------------|-----------------|-----------------|----------------|
| Supply Voltage: 230VAC | | | | | |
| Lamps Excluded | | | | | |
| Code | CIE052-1 | CIE053-1 | CIE053-3 | CIE053-4 | CIE0030 |
| Power | 35W | 2 x 35W | 2 x 35W | 2 x 35W | 2 x 35W |
| Lamp Holder | GU10 | GU10 | GU10 | GU10 | GU10 |
| IP Rating | IP44 | IP44 | IP44 | IP44 | IP44 |
| Size (mm) | Ø60 x 113 | Ø60 x 162H | Ø60 x 120 | Ø60 x 205 | Ø60 x 155 |

UP / DOWN LIGHTS

| | | | | | | | | |
|--------------------------------------------------------------------------------|-------------------|-------------------|-------------------|--------------------|-----------------|---------------|---------------|---------------|
| Supply Voltage: 230VAC Colour: Grey, Frosted PVC Lamps Excluded | | | | | | | | |
| Code | S7901 | S72603 | S7903 | S72204 | S72403 | S72201 | S72404 | |
| Power | 4 x 40W | 40W | 4 x 40W | 40W | 2 x 50W | 2 x 40W | 2 x 50W | |
| Lamp Holder | E27 | E27 | E27 | E27 | G9 | E27 | G9 | |
| IP Rating | IP54 | IP54 | IP54 | IP54 | IP54 | IP54 | IP54 | |
| Size (mm) | Ø65 x 235 | Ø90 x 190 | Ø90 x 265 | Ø90 x 170 | Ø90 x 100 | Ø110 x 300 | Ø90 x 100 | |
| Supply Voltage: 230VAC Lamps Excluded | | | Narrow Beam | | Wide Beam | | | |
| Code | X2000 | | X1002B-N | | X1002B-W | | X1001D | B5300A |
| Power | 50W | | 75W | | 100W | | 25W | |
| Lamp Holder | G9 | | G9 | | E27 | | G9 | |
| IP Rating | IP54 | | IP54 | | IP55 | | IP54 | |
| Size (mm) | Ø130 x 155 | | 150 x 80 | | Ø170 x 160 | | Ø108 x 120 | |
| Supply Voltage: 230VAC Lamps Excluded | | | | | | | | |
| Code | B2000A | B6400A | B6400B | NY6051 | | | | |
| Power | 2 x 50W | 50W | 2 x 50W | 50W | | | | |
| Lamp Holder | GU10 | GU10 | GU10 | GU10 | | | | |
| IP Rating | IP54 | IP54 | IP54 | IP54 | | | | |
| Size (mm) | 272 x 90 x 120 | 155 x 104 | 236 x 104 | 150 x 102 | | | | |
| Material: Metal | LED | LED | LED | LED | | | | |
| Code | L35-370* | L35-200* | L35-100* | L3543-160* | | | | |
| Wattage | 1 x 10W | 1 x 5W | 1 x 5W | 2 x 4W | | | | |
| Lumens | 800lm | 250lm | 400lm | 480lm | | | | |
| IP Rating | IP20 | IP20 | IP20 | IP20 | | | | |
| Colour | White | White | White | White | | | | |
| Size (mm) | 370 x 80 x 100 | 200 x 80 x 100 | 100 x 80 x 100 | 160 x 100 x 90 | | | | |
| Material: Metal | LED | LED | LED | LED | | | | |
| Code | L3544-160* | L3541-160* | L3542-160* | L3536-100B* | | | | |
| Wattage | 2 x 3W | 2 x 3W | 2 x 3W | 2 x 3W | | | | |
| Lumens | 480lm | 480lm | 480lm | 480lm | | | | |
| IP Rating | IP20 | IP20 | IP20 | IP20 | | | | |
| Colour | White | White | White | White | | | | |
| Size (mm) | 160 x 100 x 90 | 160 x 100 x 90 | 160 x 100 x 90 | 100 x 100 x 100 | | | | |

*Add colour to code: ○ CW (Cool White), ○ WW (Warm White)

UP / DOWN LIGHTS

| | | | | | |
|------------------|------------------------------------------------------------------------------------------------|------------------------------------------------------------------------------------------------|---------------------------------------------------------------------------------------|-----------------------------------------------------------------------------------------|-----------------------------------------------------------------------------------------|
| Lamps excluded |  LED 4200K |  LED 4200K |  LED |  LED |  LED |
| Code | MT2609-2W-SN | MT2609-2W-WH | LED-HALO-6-**-* | L3549-160-* | L3548-160-* |
| Wattage | 2 x 7W | 2 x 7W | 6W | 2 x 3W | 1 x 3W |
| Lumens | 1400lm | 1400lm | 310lm | 480lm | 240lm |
| IP Rating | IP20 | IP20 | IP20 | IP20 | IP20 |
| Colour | Satin Nickel | Matt White | * W / PA / BLK | White | White |
| Size (mm) | Ø140 x 350 | Ø140 x 350 | 170 x 100 x 80 | 160 x 70 x 90 | 160 x 100 x 90 |

*Add colour to code: ○ CW (Cool White), ○ WW (Warm White) *Add Material colour to code: ○ W (White), ○ PA (Polished Aluminium), ● BLK (Black)

INDOOR WALL LIGHTS

Supply Voltage: 230VAC

| | | | | |
|-------------|---------------------------------------------------------------------------------------|---------------------------------------------------------------------------------------|----------------------------------------------------------------------------------------|-----------------------------------------------------------------------------------------|
| |  LED |  LED |  LED |  LED |
| Code | LS0617-WW | L060A-DL | V29232-NS | KFD0919 |
| Wattage | 1.2W | 3W | 1 x 40W & 1 x 3W | 1 X 60W Max. |
| Lumens | 90lm | 240lm | - | - |
| Lamp Holder | - | - | E27 & LED | E27 |
| Colour | Satin White | White | Satin Nickel | Chrome / White |
| Size (mm) | Ø32 x 350 | Ø250 x 35 | Stainless Steel | Steel |
| Material | Aluminium | Aluminium | 200 x 150 x 500 | Ø230 x 370 |

| | | | | | |
|-----------------------------------------------|--------------------------------------------------------------------------------------------------|--------------------------------------------------------------------------------------------------|--------------------------------------------------------------------------------------------------|---------------------------------------------------------------------------------------------------------------------|-------------------------------------------------------------------------------------------------------------------------|
| Reading Lights Arm Length: 400mm |  LED 4200K |  LED 4200K |  LED 4200K |  LED With USB Port 4200K |  LED With 2 x USB Port 4200K |
| Code | EL202724-DL | WB-100SC | RL-6326-* | RL-7328-* | LEDB025-* |
| Power | 1W | 1 x 3W | 3W (210lm) | 3W (210lm) | 3W(100lm) |
| Lamp Holder | LED | LED | LED | LED | LED |
| Size (mm) | Ø65 x 493 | 160 x 110 | Ø150 x 110 | Ø150 x 195 | Ø150 x 150 |
| Material | Aluminium | Satin Chrome | Aluminium | Aluminium | Aluminium |
| Colour | Chrome | Satin Chrome | White / Black / Satin Nickel | | |

* Add colour to code: ○ WH (White), ● BK (Black), ○ SN (Satin Nickel)

| | | | | | | |
|-------------------------------------|----------------------------------------------------------------------------------------------------|----------------------------------------------------------------------------------------------------|-----------------------------------------------------------------------------------------------------|------------------------------------------------------------------------------------------------------|------------------------------------------------------------------------------------------------------|-----------------------|
| Mirror Light LED 4200K |  Lamps excluded |  Lamps excluded |  Lamps excluded |  Lamps excluded |  Lamps excluded | |
| Code | MB-800 | FY-2316 | HK-149240000 | HK-149240001 | Y102/1 | Y102/2 |
| Power | 2 x 36W (Double Sided) | Max. 50W | 2 x 40W | 3 x 40W | 20W | 2 x 20W |
| Lamp Holder | LED | E14 | E27 | E27 | G4 | G4 |
| Size (mm) | Ø220 | 165 x 260 x 140 | 300 x 90 x 250 | W500 x L100 x H250 | 110 x 110 | 220 x 110 |
| Material | Electrodeposited Chromium | Aluminium | Glass & Steel | Glass & Steel | Steel, iron & crystal | Steel, iron & crystal |
| Colour | Chrome | Matt Silver | White | White | Black | Black |

| | | | | |
|-------------------------------------------------------------------------------------|-------------------------------------------------------------------------------------|--------------------------------------------------------------------------------------|---------------------------------------------------------------------------------------|-------------------------|
|  |  |  |  | |
| Code | HF-12-1908H | HF-12-1934H | HF-12-1942H | HF-12-1952H |
| Lamp Holder | E27 | E27 | E27 | E27 |
| Material | Metal Body, Glass Cover | Metal Body, Glass Cover | Metal Body, Glass Cover | Metal Body, Glass Cover |

CEILING LIGHTS

| | Opal Fittings | | | | Clear Fittings | | | |
|-------------------------------------------------------------------------------------|--------------------------|----------------------------|----------------------------|----------------------------|----------------------------|--------------------------|----------------------------|--|
| Lamps excluded | | | | | | | | |
| Code | NB250-P | NB280-P | NB250-PCL | NB280-PCL | | | | |
| Size | 6" | 8" | 6" | 8" | | | | |
| Lamp Holder | B22/PVC | B22/Porcelain | B22/PVC | B22/PVC | | | | |
| Material | PVC Bowl | PVC Bowl | PVC Bowl | PVC Bowl | | | | |
| Spare Bowl | NB250-P-DIF | NB280-P-DIF | NB250-PCL-DIF | - | | | | |
| Glass Bowl | NB250-G | - | - | - | | | | |
| | Clear Prismatic Fittings | | Smoky Fittings | | Opal Fitting + Lamp | | | |
| Lamps excluded | | | | | All in one | | | |
| Code | CDS1-150-CP | CDS1-200-CP | CDS1-150-S | CDS1-200-S | NB250-5W-PW | | | |
| Size | 6" | 8" | 6" | 8" | 6" | | | |
| Lamp Holder | E27 | E27 | E27 | E27 | B22 / PVC | | | |
| Material | PMMA Bowl | PMMA Bowl | PMMA Bowl | PMMA Bowl | PMMA Bowl | | | |
| Jam Jars | | | | Ceramic | | Nylon | | |
| Lamps excluded | | | | | | | | |
| | | | | | For 6" bowl | | For 8" bowl | |
| Code | JJ60-B22 | PJ60-B22 | GD008-S | GD008-L | CLH22-3-C (Ceramic) | CLH22-3-N (Nylon) | CLH22-8-C (Ceramic) | |
| Lamp/Watts | B22/60W | B22/60W | E27 | E27 | B22 / 60W | | B22 / 60W | |
| Material | Glass | PMMA | PMMA | PMMA | Ceramic or Nylon | | Ceramic or Nylon | |
| Size (mm) | Ø90 x 190 | Ø90 x 190 | Ø85 x 170 | Ø140 x 270 | Ø105 x 50 | | Ø120 x 30H | |
| Lamps included | | | | | | | | |
| Code | PJ60-9W* | JJ60-9W* | GD008-S-9W* | GD008-L-20W-WW | | | | |
| Damp/Watts | B22/9W | B22/9W | E27/9W | E27/20W | | | | |
| Material | PMMA | Glass | PMMA | PMMA | | | | |
| Size (mm) | Ø90 x 190 | Ø90 x 190 | Ø85 x 270 | Ø140 x 270 | | | | |
| *Add colour to code: ● WW (Warm White) 3200k, ○ CW (Cool White) 4000k | | | | | | | | |
| Supply Voltage: 230VAC | | | | | | | | |
| Code | MX-236-15W | MX-238-8W | MX-262-400 | MX-263-400 | | | | |
| Power | 15W | 8W | 26W | 26W | | | | |
| Lumen | 1300lm | 600lm | 2210lm | 2210lm | | | | |
| IP Rating | IP20 | IP20 | IP20 | IP20 | | | | |
| Colour Temp | 4000K | 4000K | 6000K | 6000K | | | | |
| Size (mm) | Ø400 x 65 | Ø300 x 50 | Ø480 x 50 | 460 x 460 x 50 | | | | |
| Material | PC base / PC diffuser | PC base / PC diffuser | PC base / PC diffuser | PC base / PC diffuser | | | | |
| Supply Voltage: 230VAC | | | | | | | | |
| Dimmable & CCT adjustable. c/w remote | | | | | | | | |
| Code | MLS-XD640D-60 | LAA12-* | LAA16-* | LAA20-* | MY-380-01 | | | |
| Power | 60W | 12W | 16W | 24W | 18W | | | |
| Lumen | 4500lm | 888lm | 1184lm | 1480lm | 1080lm | | | |
| IP Rating | IP20 | IP20 | IP20 | IP20 | IP20 | | | |
| Colour Temp | 2800-6700K | *○CW (4000K) / ○DL (6000K) | *○CW (4000K) / ○DL (6000K) | *○CW (4000K) / ○DL (6000K) | 6000K | | | |
| Size (mm) | Ø646 x 94 | Ø260 x 80 | Ø300 x 98 | Ø385 x 100 | Ø380 x 100 | | | |
| Material | Steel base / PC diffuser | Steel base / PC diffuser | Steel base / PC diffuser | Steel base / PC diffuser | Steel base / PC diffuser | | | |

Indoor

LIGHTING

CEILING LIGHT FITTINGS

Supply Voltage:
230VAC



LED



LED



LED



LED

| Code | MY-250-01 | ASL-005 | LAB16 | RW6100-15C |
|-------------|--------------------------|------------------------|-----------------------|-----------------------|
| Power | 12W | 20W | 16W | 10W |
| Lumen | 720lm | 1100lm | 900lm | 600lm |
| IP Rating | IP20 | IP20 | IP20 | IP20 |
| Colour Temp | 6000K | 6000K | 6000K | 6000K |
| Size (mm) | Ø280 x 80 | Ø350 x 105 | Ø330 x 75 | Ø250 x 80 |
| Material | Steel base / PC diffuser | S/S Trim / PC diffuser | PC base / PC diffuser | PC base / PC diffuser |

Supply Voltage:
230VAC



LED



LED



LED



LED



LED

| Code | LAC12 | LAC18 | LAC22 | LAD12 | LAD22 |
|-------------|--------------------------|--------------------------|--------------------------|--------------------------|--------------------------|
| Power | 12W | 18W | 22W | 12W | 22W |
| Lumen | 888lm | 1350lm | 1650lm / 1440lm | 900lm | 1650lm |
| IP Rating | IP20 | IP20 | IP20 | IP20 | IP20 |
| Colour Temp | 6000K | 6000K | 6000K | 6000K | 6000K |
| Size (mm) | Ø260 x 100 | Ø330 x 100 | Ø400 x 100 | Ø260 x 100 | Ø400 x 100 |
| Material | Steel base / PC diffuser | Steel base / PC diffuser | Steel base / PC diffuser | Steel base / PC diffuser | Steel base / PC diffuser |

Supply Voltage:
230VAC



LED



LED



LED



LED



LED



LED

| Code | LAE12 | LAE22 | MY-250-06 | MY-380-06 | L29199-230 | L29199-280 |
|-------------|------------------------|------------------------|------------------------|------------------------|------------------------|------------------------|
| Power | 12W | 22W | 12W | 18W | 12W | 15W |
| Lumen | 900lm | 1650lm | 660lm | 990lm | 1200lm | 1500lm |
| IP Rating | IP20 | IP20 | IP20 | IP20 | IP20 | IP20 |
| Colour Temp | 6000K | 6000K | 6000K | 6000K | 6000K | 6000K |
| Size (mm) | Ø260 x 100 | Ø400 x 100 | Ø340 x 100 | Ø380 x 105 | Ø230 | Ø280 |
| Material | S/S Trim / PC diffuser | S/S Trim / PC diffuser | S/S Trim / PC diffuser | S/S Trim / PC diffuser | S/S Trim / PC diffuser | S/S Trim / PC diffuser |



Trim Rings



| Code | XCL-1728-* | XCL-1738-* | XCL-1743-* |
|------------------|---------------------------|---------------------------|---------------------------|
| Power | 12W | 24W | 36W |
| Lumen | 900lm | 1800lm | 2700lm |
| IP Rating | IP44 | IP44 | IP44 |
| *Colour Temp | CW (4200K), DL (6000K) | CW (4200K), DL (6000K) | CW (4200K), DL (6000K) |
| Size (mm) | Ø280 x 63 | Ø380 x 63 | Ø435 x 63 |
| Material | Steel body + ABS diffuser | Steel body + ABS diffuser | Steel body + ABS diffuser |
| White Trim | XCL-1728-TR-WH | XCL-1738-TR-WH | XCL-1743-TR-WH |
| Black Trim | XCL-1728-TR-BK | XCL-1738-TR-BK | XCL-1743-TR-BK |
| Wood Finish Trim | XCL-1728-TR-WD | XCL-1738-TR-WD | XCL-1743-TR-WD |

Input Voltage: 230VAC | Trim Rings available in White, Black or Wooden Finish | Trim Ring to be ordered Separately

Lamps excluded

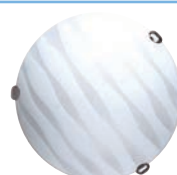

| Code | HF-12-1908F | HF-16-1908F | HF-12-1934F | HF-16-1934F | HF-12-1942F | HF-16-1942F | HF-12-1952F | HF-16-1952F |
|-------------|-------------------------|-------------|-------------------------|-------------|-------------------------|-------------|-------------------------|-------------|
| Lamp Holder | 2 x E27 | 2 x E27 | 2 x E27 | 2 x E27 | 2 x E27 | 2 x E27 | 2 x E27 | 2 x E27 |
| Size (mm) | Ø300 (12") | Ø400 (16") | Ø300 (12") | Ø400 (16") | Ø300 (12") | Ø400 (16") | Ø300 (12") | Ø400 (16") |
| Material | Metal Body, Glass Cover | | Metal Body, Glass Cover | | Metal Body, Glass Cover | | Metal Body, Glass Cover | |

CEILING LIGHTS

| | | | | |
|----------------|---------------------|--------------------|--------------------|--------------------|
| Lamps Excluded | | | | |
| Code | HK-149280003 | DL-118-C | DL-0208 | DL-0211 |
| Power | 3 x 60W | 1 x 60W | 1 x 60W | 1 x 60W |
| Lamp Holder | E27 | E27 | E27 | E27 |
| Size (mm) | 400 x 400 x 85 | 235 x 235 | 190 x 190 | 215 x 215 |
| Material | Glass & Steel | Clear Glass | Clear Glass | Clear Glass |
| | | | | |
| Code | GCL-0508-S | GCL-0508-R | GCL-0510-S | GCL-0510-R |
| Power | 1 x 40W | 1 x 40W | 1 x 40W | 1 x 40W |
| Lamp Base | E27 | E27 | E27 | E27 |
| Size (mm) | 200 x 200 | Ø200 | 250 x 250 | Ø250 |
| Material | Metal Base / Glass | Metal Base / Glass | Metal Base / Glass | Metal Base / Glass |
| Colour | Opal | Opal | Opal | Opal |

CEILING SPOT LIGHTS

| | | | | | |
|------------------------------------------|---------------------|---------------------|--------------------|---------------------|---------------------|
| Base Size: Ø80mm Lamps Excluded | | | | | |
| Code | KT-0004-1-SN | KT-0004-2-SN | KT-0006-2GM | KT-0004-3-SN | KT-0004-5-SN |
| LED Power | 1 x GU10 | 2 x GU10 | 2 x GU10 | 3 x GU10 | 3 x GU10 |
| Size (mm) | 110 x 80 x 105 | 275 x 80 x 145 | Ø150 x 100 | 440 x 85 x 140 | 250 x 230 x 145 |
| Colour | Satin Nickel | Satin Nickel | Gun Metal | Satin Nickel | Satin Nickel |
| Base Size: Ø80mm Lamps Excluded | | | | | |
| Code | KT-6005-1-* | KT-6005-2-* | KT-6005-3-* | KT-6005-5-* | |
| LED Power | 1 x GU10 | 2 x GU10 | 3 x GU10 | 3 x GU10 | |
| Size (mm) | 105 x 80 x 90 | 275 x 80 x 110 | 485 x 80 x 110 | 250 x 230 x 145 | |
| Colour | SN / WH | SN / WH | SN / WH | SN / WH | |

*Add fitting colour to code: **SN** (Satin Nickel) or **WH** (White)

| | | | | |
|------------------------------------------------|-------------------|-------------------|-------------------|-------------------|
| Shade Size: Ø52 x 75mm Lamps Excluded | | | | |
| Code | KT-0001-1* | KT-0001-2* | KT-0001-3* | KT-0001-4* |
| LED Power | 1 x GU10 | 2 x GU10 | 3 x GU10 | 4 x GU10 |
| Size (mm) | 150 x 90 x 140 | 320 x 80 x 140 | 460 x 80 x 140 | 260 x 220 x 140 |
| Colour | White/Black | White/Black | White/Black | White/Black |

*Add **-BK** to code for Black

Indoor

LIGHTING

CEILING SPOT LIGHTS

| | | | | |
|---------------------------------------------------------|--------------------------------------------------------------------------------------------|------------------------------|------------------------------|------------------------------|
| Base Size: Ø80mm Lamps Excluded | | | | |
| Code | KT-0006-1 | KT-0006-2 | KT-0006-3 | KT-0006-5 |
| LED Power | GU10 | GU10 | GU10 | GU10 |
| Size (mm) | 80 x 135 x 115 | 275 x 160 x 135 | 385 x 160 x 135 | 360 x 360 x 150 |
| Colour | Satin Nickel / Frosted Glass | Satin Nickel / Frosted Glass | Satin Nickel / Frosted Glass | Satin Nickel / Frosted Glass |
| Beam Angle: 30° Colour Temp: 4000K | | | | |
| Code | SLD07W1C-* | SLD07W2E-* | SLD07W3E-* | SLD07W3C-* |
| LED Power | 5W | 10W | 16W | 16W |
| Size (mm) | Ø90 x 90 | 105 x 220 | 105 x 360 | Ø200 x 105 |
| Colour | *Add lamp colour to code: WH (White), CH (Chrome), N (Brushed Nickel) | | | |
| Beam Angle: 30° Colour Temp: 4000K | | | | |
| Code | SLD08W1C-* | SLD08W2A-* | SLD08W3F-* | SLD08W3C-* |
| LED Power | 4.1W | 7W | 13.5W | 13.5W |
| Size (mm) | Ø90 x 130 | 150 x 225 | 150 x 415 | Ø200 x 130 |
| Colour | *Add lamp colour to code: CH (Chrome), N (Brushed Nickel) | | | |
| Beam Angle: 30° Colour Temp: 4000K | | | | |
| Code | SLD04W1C-* | SLD04W2A-* | SLD04W3F-* | |
| LED Power | 3.8W | 7.6W | 11.4W | |
| Size (mm) | Ø70 x 80 | 140 x 225 | 140 x 405 | |
| Colour | *Add lamp colour to code: WH (White), N (Matt Nickel Paint) | | | |
| Supply Voltage: 230VAC Colour Changing & White | | | | |
| Code | SLD40I1E | SLD40I2E | SLD40I3E | SLD40I4E |
| LED Power | 6W | 12W | 18W | 24W |
| Size (mm) | 210 x 140 x 10.5 | 290 x 175 x 120 | 430 x 175 x 120 | 255 x 155 x 250 |

Indoor

LIGHTING

CEILING SPOT LIGHTS

| | | | | | | |
|--------------------------------------------|--------------------|--------------------|--------------------|--------------------|------------------|------------------|
| Supply Voltage: 230VAC Lamp excluded | | | | | | |
| Code | 140010000 | 140010001 | 140160000 | 140160001 | 54185-1-* | 54185-3-* |
| Power | 50W | 2 x 50W | 50W | 2 x 50W | 1 x 25W | 3 x 25W |
| Lamp Holder | GU10 | GU10 | GU10 | GU10 | E14 | E14 |
| Size (mm) | W120 x L144 x H138 | W320 x L120 x H141 | W100 x L125 x H146 | W320 x L120 x H141 | Ø120 x 120 | Ø200 x 120 |
| Material | Stainless Steel | Stainless Steel | Stainless Steel | Stainless Steel | Plastic + Steel | Plastic + Steel |

* Add to Code: **W** (White) , **S** (Silver)

| | | | | |
|--------------------------------------------------------------|-----------------|-----------------|-----------------|-----------------|
| Supply Voltage: 230VAC Lamps excluded R50 Reflector | | | | |
| Code | A448-1 | A448-2 | A448-3R | A448-3P |
| Power | 40W Max | 80W Max | 120W Max | 120W Max |
| Lamp Holder | E14 | E14 | E14 | E14 |
| Lamp Size (mm) | Ø61 x 140 | 140 x 160 | 140 x 160 | Ø160 x 140 |
| Turning Angle | 270° | 270° | 270° | 270° |
| Material | Stainless Steel | Stainless Steel | Stainless Steel | Stainless Steel |

| | | | | |
|---------------------------------------------|------------------|------------------|------------------|------------------|
| Supply Voltage: 230VAC Lamps excluded | | | | |
| Code | SPL-026 | SPL-027 | SPL-029 | SPL-030 |
| Power | 60W | 60W | 60W | 60W |
| Lamp Holder | E27 CFL | E27 CFL | E27 CFL | E27 CFL |
| Colour | White | White | White | White |
| Description | 1 x Lamp fitting | 2 x Lamp fitting | 3 x Lamp fitting | 2 x Lamp fitting |

NB: Only Reflective Lamps R60 to be used







| | | | |
|---------------------------------------------|------------------|------------------|------------------|
| Supply Voltage: 230VAC Lamps excluded | | | |
| Code | 2RP-5410* | 3RP-5410* | 3BR-5410* |
| Power | 2 x 50W | 3 x 50W | 3 x 50W |
| Lamp Holder | MR16 | MR16 | MR16 |
| Colour | Stainless Steel | Stainless Steel | White |
| Description | 2 x Lamp fitting | 3 x Lamp fitting | 3 x Lamp fitting |

*Add fitting colour to code: **S** (Satin Silver) or **W** (White)

PICTURE LIGHTS

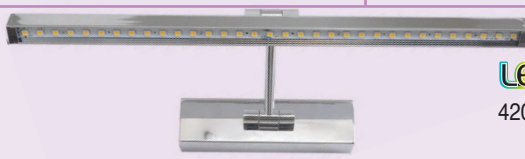
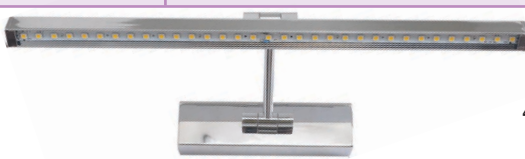
| | | | | |
|---------------------------------------------|--------------------------------------|-----------------|--------------------------------|------------------------|
| Low Voltage | | | | |
| Supply Voltage: 230VAC Lamps excluded | Comes as a set of two picture lights | | c/w 60W electronic transformer | |
| Code | WL-99177 | WL-99369 | MT1751-1W | MT1751-2W |
| Power | 20W | 2 x 20W | 1 x 1W | 2 x 1W |
| Lamp Holder | G4 | 2 x G4 | LED | LED |
| Size (mm) | Ø6 x 300 | Ø10 x 300 | 180 x 105 x 172 | 370 x 105 x 172 |
| Material | Metal | Metal | Chrome | Chrome |
| Colour | Gold and Frosted White | Silver | Chrome / Frosted Glass | Chrome / Frosted Glass |

PICTURE LIGHTING

| | | | |
|-------------|-----------------------------------------------------------------------------------|------------------------------------------------------------------------------------|-------------------------------------------------------------------------------------|
| Type: T5 |  |  |  |
| Code | MB-059-8W | MB-059-14W | MB-059-21W |
| Wattage | 5W | 14W | 14W |
| Size (mm) | 350 x 320 x 330 | 614 x 180 x 120 | 914 x 180 x 120 |
| Material | Matt Silver | Matt Silver | Matt Silver |
| Spare Lamp | FLT5-8 | FLT5-14 | FLT5-21 |
| |  |  | |
| Code | MB-501A | MB-509 | |
| Wattage | 5W | 8W | |
| Size (mm) | 330 x 180 x 50 | 480 x 180 x 50 | |
| Material | Chrome | Chrome | |
| |  |  |  |
| Code | MB-096-5W-* | MB-096-8W-* | MB-096-12W-* |
| Wattage | 5W | 8W | 12W |
| Size (mm) | 350 x 150 x 160 | 480 x 150 x 160 | 650 x 150 x 160 |
| Material | Chrome | Chrome | Chrome |

*Add colour to code: ○ **CW** (Cool White 4000k), ○ **WW** (Warm White 3000k)

LINEAR CEILING LIGHTS

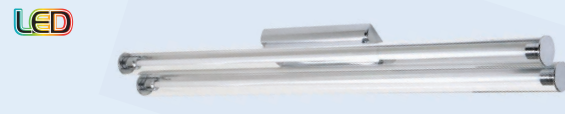

Input Voltage: 230VAC | LED Lamp Included

| | | | | |
|-------------|-------------------------------------------------------------------------------------|--------------------------------------------------------------------------------------|--------------------|--------------------|
| |  |  | | |
| Code | MB-116-12W | MB-116-18W | MB116-2-12W | MB116-2-18W |
| Lamp Holder | LED | LED | LED | LED |
| Power | 1 x 8W | 1 x 13W | 2 x 8W | 2 x 13W |
| Size (mm) | 665 x 60 x 100 | 965 x 50 x 75 | 665 x 140 x 100 | 965 x 60 x 100 |

Input Voltage: 230VAC | Material: Steel | Body Colour: Satin Nickel | LED Lamps included

| | | | |
|-------------|-------------------------------------------------------------------------------------|--------------------------------------------------------------------------------------|---------------------------------------------------------------------------------------|
| |  |  |  |
| Code | LED-401-2X9 | LED-401-2X13 | LED-403-2X9 |
| Lamp | LED Tube | LED Tube | LED Tube |
| Power | 2 x 9W | 2 x 13W | 2 x 9W |
| Size (mm) | 665 x 105 | 1000 x 150 | 880 x 160 |

Input Voltage: 230VAC | Material: Steel | Body Colour: Satin Nickel | LED Lamps included

| | | | |
|-------------|-------------------------------------------------------------------------------------|--------------------------------------------------------------------------------------|---------------------------------------------------------------------------------------|
| |  |  |  |
| Code | LED-403-2X18 | LED-404-2X9 | LED-404-2X18 |
| Lamp | LED Tube | LED Tube | LED Tube |
| Power | 2 x 18W | 2 x 9W | 2 x 18W |
| Size (mm) | 1480 x 160 | 790 x 210 | 1400 x 210 |

DECORATIVE CORD

| | | | | |
|-------------|-------------------|-------------------|-------------------|-------------------|
| | | | | |
| Code | WLIT-C* BL | WLIT-C* BR | WLIT-C* GN | WLIT-C* GR |
| Description | Blue Cord | Brown Cord | Green Cord | Grey Cord |
| | | | | |
| Code | WLIT-C* R | WLIT-C* BK | WLIT-C* WH | WLIT-C* Y |
| Description | Red Cord | Black Cord | White Cord | Yellow Cord |

*Add length of cable to code: **2M, 5M, 10M, 100M** Material: Cotton | Size: 2 x 0.75 (6.2mm)

DECORATIVE ACCESSORIES

| | | | | |
|-------------|----------------------------|---------------------------|----------------------------|----------------------------|
| | | | | |
| Code | TPLH-E27 | LH-E27-WH | LH-E27-BK | LH-E27-CH |
| Description | E27 Lamp Holder | White E27 Lamp Holder Kit | Black E27 Lamp Holder Kit | Chrome E27 Lamp Holder Kit |
| Material | Black Thermo Plastic | Metal | Metal | Metal |
| Size | Ø40 x 60 | Ø42 x 62 | Ø42 x 62 | Ø42 x 62 |
| | | | | |
| Code | LH-E27-VC | LH-E27-VB | LH-E27-VCH | LH-E27-VBK |
| Description | Vintage Copper Lamp Holder | Vintage Brass Lamp Holder | Vintage Chrome Lamp Holder | Vintage Black Lamp Holder |
| Material | Aluminium | Aluminium | Aluminium | Aluminium |
| Size | Ø50 x 72 | Ø50 x 72 | Ø50 x 72 | Ø50 x 72 |

Accessories

| | | | | | |
|-------------------------------------------------------------------------------------------------------|------------------|------------------|------------------|--------------------|------------------------------------------------------------------------------------------------------------------------|
| | | | | | |
| Code | CR-1-120* | CR-2-120* | CR-3-120* | SHA-PL-5 | BCR-1-100-E27* |
| Description | 1 Way Rose | 2-Way Rose | 3-Way Rose | 5-Way Shadow Plate | Ceiling Rose Kit |
| Material | Metal | Metal | Metal | Metal | Metal |
| Size (mm) | Ø120 x 25(L) | Ø120 x 25(L) | Ø120 x 25 | Ø800 x 30 | Ø100 x 25 |
| *Add body colour to code: WH (White), BK (Black), CH (Chrome), BR (Brass) | | | | | Cord Length: 1m *Add body colour to code: VC (Vintage Copper), B (Bronze), VBK (Vintage Black) |

LIGHTING

| | | | | | | |
|-------------|------------------|-------------------|--------------------|---------------------|------------------|-------------------|
| 10 Per Pack | | | | | | |
| Code | THT-25/10 | THT-120/10 | LNUT-M10/10 | LWASH-M10/10 | CG-13/10* | NWCG-13/10 |
| Description | Threaded Tube | Threaded Tube | Nut | Washer | Cable Grip | Cable Grip |
| Material | Metal | Metal | Metal | Metal | Plastic | Plastic |
| Size (mm) | M10 x 25 | M10 x 120 | M10 | M10 | Ø13 x 17 | Ø13 x 17 |

*Add body colour to code: **WH** (White), **BK** (Black), **T** (Transparent)

LIGHTING ACCESSORIES

| | | | | | | | |
|-----------------------------------------------------------------------------------------------|------------------------------------------------|------------------------------------------------------------------------------------|---------------------------------------|------------------------------------------------------------------------------------------------------------------------------------------------------------------------------|----------------------------------------|------------------------------------------------------------------------|---------------------------------------------------|
| Rocker Switch Black White | | On/Off switch with 1.5m cable to 2 pin Euro Plug & 1m wire open ended for lamp | | Foot Operated Switch Black White | | Latching Pushbutton Switch Black White | |
| R-303B | R-303W | R-313W | | ZE-127FB | ZE-127FW | ZE-127B | ZE-127W |
| 2 Amp 250V | 2 Amp 250V | 2 Amp 250V | | 1 Amp 250V | 1 Amp 250V | 6 Amp 250V | 6 Amp 250V |
| Hand Operated Table Lamp Dimmers c/w 2,5m cable White Black | | | | Touch control White Clear | | Foot Dimmer NEW | Breather NEW |
| KLD-227W | KLD-227G | RT101B | RT101T | RT101SB | RT101ST | RT81N | M12-1.5/5 |
| Input: 230VAC Lamp: 230VAC Rating: 200W max | | Input: 230VAC Lamp: 230VAC Rating: Max 10 LED Lamps (100W Total) | | Input: 230VAC Lamp: 230VAC Rating: Max 10 LED Lamps (100W Total) | | Input: 230VAC Lamp: 230VAC Rating: Max 10 LED Lamps (100W Total) | Breathing Screw Ø12 x 15 Comes in pack of 5 |
| Luminaire Disconnect Connector - 2 Pole, Yellow NEW | | Knife Switches U | | Surge Protectors - Can be installed in fitting or junction box See main catalogue page 266 - 272 for surge protection for distribution boards NEW IP67 | | | |
| 873-902 | M29-3P-S | M29-3P-L | Code | LP2-8 | M995* | GSPD1 | GSPD1S |
| Rated Current: 6A Nominal Volts: 400V Pole: 2 | 3 Pin I Rated 400V Class II 27 x 20 x 27 | 3 Pin I Rated 400V Class II 40 x 30 x 40 | Connection Vc Up Imax (8/20) | Parallel 275VAC 710V 5kA | Series 120-277VAC ≥1000V 10kA | Parallel 120 - 277VAC ≥1500V 20kA | Parallel 120 - 277VAC 850V 10kA |
| * Max Load Current = 3A - NOTE: Load will be disconnected when SPD reaches end of life | | | | | | | |

LAMP HOLDERS

Metal Lamp Holders

| | | | | | | |
|-----------------------------------------------------------|-----------------|-----------------------------|-----------------|------------------|-----------------|--|
| 10mm 0142 Authorisation Certificate No. XE2377A | XE2377B | 10mm Entry YE317A | | | | |
| CLH22-10B | CLH22-0B | CLH22-10SW | CLH27-0B | CLH27-10B | CLH14-0B | |
| B22 | B22 | B22 (switched) | E27 | E27 | E14 | |

Nylon Lamp Holders

Illumination Cable & Cable Piercing Lamp Holders

| | | | | | | |
|-------------|---------------------------|----------------------------------|-----------------------------------------------------------------------------------------------------------------------|------------------|----------------------------|------------------------------------------------------------------------------|
| | | | | | | |
| W626 | F505-E27 | ALH40-0B | CLH14-TH* | CLH27-TH* | 393 | WIR |
| E27 Angle | Base Mount E27 100W | E40 Batten Mount Aluminium | E14 2A 250V | E27 2A 250V | B22 Cable Piercing Type | WI100* BK |
| | | | Spare Locking Ring Code CLH14-THLR* CLH27-THLR* *Add colour to code: WH (White),BK (Black) | | | 100m Black Illumination Cable *Add length to code 5m, 10m, 20m, 50m |

LAMP HOLDERS

| Nylon Lamp Holders | | Porcelain Lamp Holder | Bakelite Lamp Holder | Ceramic Lamp Holders | |
|--------------------|-----------------|-----------------------|----------------------|----------------------|-----------------|
| | | | | | |
| CLH200* | CLH209A* | CLH22-1P | CLH200T | CLH27-1P | CLH40-1P |
| B22 | B22 | B22 | E27 | E27 | E40 |

*Add colour to code: ○ WH (White), ● BK (Black) CLH200,CLH209A Also available in pack of 5 Add /5 to code

Lamp Holders

| | | | | |
|-----------------------|-----------------------|-----------------|-------------|-------------|
| | | | | |
| HL001 | HL002 | W602-B22 | W617 | W622 |
| B22 / E27 Both Fitted | B22 / E27 Both Fitted | B22 | B22 Angle | E27 |

Fluorescent Lamp Holders

| | | | | | | |
|---------------------|---------------|---------------|---------------|---------------|---------------|---------------------|
| | | | | | | |
| PT-C01 (set) | PT-C02 | PT-C06 | PT-C07 | PT-C08 | PT-C05 | PT-C09 (set) |
| G13 | G13 | G13 | G13 | G13 | G5 | Slimline |

| | | | | | | |
|---------------------|---------------------|---------------------|----------------------------------------|----------------------------------------|---------------------------------------|---------------------------------|
| | | | | | | |
| MR16-1U/10 | MR16-3U/10 | MR11-1U/10 | LH2-ST | D-GUB | D-CLIP1 | D-CLIP2 |
| Spare clip for MR16 | Spare clip for MR16 | Spare clip for MR11 | GU lamp holder c/w terminals & bracket | GU lamp holder c/w terminals & bracket | Spare mounting clip fits SL-076 & 250 | Spare mounting clip fits SL-203 |

Dichroic Lamp Holders

| | | | | | |
|---------------|---------------|---------------|---------------|---------------|---------------|
| | | | | | |
| CLH202 | CLH205 | CLH206 | CLH207 | CLH208 | CLH209 |
| MR16 (G5.3) | MR16 (G5.3) | MR16 (G5.3) | MR16 (G5.3) | GU10 | GV10 (GZ10) |

Rx7s Lamp Holders

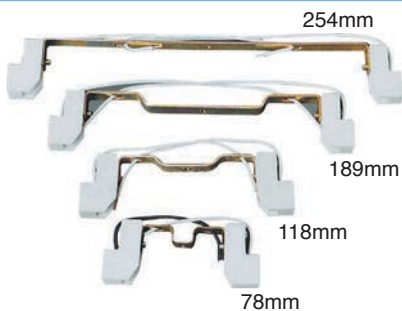

| Code | Description |
|-----------------|----------------------------------|
| RX7S-78 | To accept 78mm. Lamps up to 150W |
| RX7S-118 | To accept 118mm. Lamps 150W-500W |
| RX7S-189 | To accept 189mm. Lamps 1000W |
| RX7S-254 | To accept 254mm. Lamps 1500W |

| | |
|---------------|---------------|
| | |
| CLH210 | CLH211 |
| G9 | G12 |

LAMP HOLDERS

Starter Holders

| | | | | | | |
|-------------|------------------------------------------------|--------------------------|-------------------------------|--------------------------------------------------------------------------------------|--------------------------------|---------------------------------------------------|
| | | | | | | |
| Code | PT-B09 | PT-B03 | A321 | CLH22-BT | LH47-E27 | LHA-E27-1.5m |
| Description | Starter / Fuse link base with mounting bracket | Starter / Fuse link base | Ceiling Mount Pull Switch 10A | B22 Batten-mount lamp holder with 4m cable, on/off switch and battery clamps 70W max | Pendant - 100W E27 Lamp Holder | E27 Lampholder Adaptor with 1.5m 2 x 0.75mm cable |

Lamp Holder Adaptors - <500V

| | | | | | | |
|-------------|----------|----------|----------|----------|----------|----------|
| | | | | | | |
| Code | LHA-01 | LHA-02 | LHA-03 | LHA-04 | LHA-10 | LHA-05 |
| Description | B22-E27 | E27-B22 | E27-E40 | E27-GU10 | B22-GU10 | E40-E27 |
| Size (mm) | 52 x Ø34 | 50 x Ø33 | 80 x Ø47 | 44 x Ø29 | 52 x Ø35 | 52 x Ø44 |

| | | | | |
|-------------|----------|----------|----------|-------------------------------------------------------------------------------------------------------------------|
| | | | | |
| Code | LHA-07 | LHA-08 | LHA-09 | LT5020 |
| Description | E14-E27 | E27-E14 | E40-E40 | Buzzer & LED indication if lamp is in working condition. To test: G13, B15d, G5, G4, Gu5.3, GY6.35, E27, E14, E10 |
| Size (mm) | Ø40 x 64 | Ø29 x 44 | Ø47 x 99 | |

SENSOR LAMP HOLDERS

| | Motion Sensor | | Lamp Holders with Daylight Sensor | | Sound Sensor |
|----------------|---------------|------------|-----------------------------------|------------|--------------|
| | | | | | |
| Code | RW-450 | RW-451 | RW-470 | RW-471 | RW-480 |
| Volts | 220-240VAC | 220-240VAC | 220-240VAC | 220-240VAC | 220-240VAC |
| Output | 60W (max) | 60W (max) | 60W (max) | 60W (max) | 60W (max) |
| Range/ Angle | 6m/120° | 6m/360° | - | - | - |
| Size (mm) | Ø 64 x 127 | Ø 56 x 132 | Ø 55 x 98 | Ø 38 x 75 | Ø63 x 95 |
| Light On Timer | 120sec | 120sec | - | - | 60 sec |
| Ambient Lux | <10lux | <10lux | <10lux | <10lux | 3-5lux |

HIGH FREQUENCY SENSOR MODULE



- 1) Time
- 2) Lux
- 3) Meter
- 4) Standby

2 Level Light Dimming Function

| Code | HD-627DF | HD-627TF |
|-------------------------|-----------------------------------------|-----------------------------|
| Rated Voltage | 220-240V ~ 50/60Hz | 220-240V ~ 50/60Hz |
| Switching Capacity: | Max. 100W | |
| Incandescent | Max. 60/80/100W (electronic) / Max. 80W | 10 - 100W |
| AC Halogen / LV Halogen | Max. 100VA/60W | 10 - 100W / 10 - 100W |
| Flourescent / LED Lamp | Max. 30mA Sink Current | 5 - 80W (LED Lamp Dimmable) |
| Energy Saving Lamp | Max. 15pcs Dimmable | 10-100VA (Dimmable) |
| 1-10VDC Interface | Ballast or LED Driver | - |
| Range/Angle | Approx. Ø 8m | Approx. Ø 8m |
| Size (mm) | 75.5 x 49.5 x 32.5H | 75.5 x 49.5 x 32.5H |
| Light ON Timer | 5sec - 30min & Test | 5sec - 30min & Test |
| Lux | 5Lux - "☀️" ∞ | 5Lux - "☀️" ∞ |

- Auto Dimming
- No movement dims to set level on unit
- With movement full power

PIR SENSORS IP20



Low Profile

Zero Point Relay Switching



Long Range - 12m

Zero Point Relay Switching



Optional remote controller Code: **MANDOCR**

| Code | CIRCUMAT + | CIRCUMAT PRO CR |
|----------------|------------------------------------------------------------------------------------------------------------------------------------------------------------------------------------|--------------------------------------------------------------------------------------------------------------------------------------------------------------------------------------|
| Voltage | 230VAC | 230VAC |
| Output | 1200W Incandescent 400VA Fluorescent 1000VA Low Voltage (12VAC) Halogen Lamps 1200W Halogen (230VAC) 500VA Low Consumption Lamps 500VA Downlight Lamps 500VA LED | 2200W Incandescent 1200VA Fluorescent 2000VA Low Voltage (12VAC) Halogen Lamps 2200W Halogen (230VAC) 1000VA Low Consumption Lamps 900VA Downlight Lamps 500VA LED |
| Range Angle | 9m / 360° at 3m(H) | 30m / 360° at 12m(H) |
| Size (mm) | Ø120 x 25 | Ø140 x 68 |
| Light on Timer | 3s - 30min | 1-10min |
| Lux | 5 - 2000Lux | 10-1000Lux |

DALI - Presence Detection Equipped with DALI Two-Way Communication



1-10V - Analog Output for Dimmable Lighting Control | Adjust Indoor Lighting Based on Natural Outdoor Light | Suitable for 1-10V Dimmable Lamps



1-10V - Presence Detection with Analog Output 1 -10V for Dimmable Lighting Control



| Code | CIRCUMAT-DALI | DICROMAT1-10V | CIRCUMAT PRO 1-10V |
|----------------|-----------------------|------------------------------------------------------------------------------------------------------------------------------------------------------------------------------------|-------------------------------------------------------------------------------------------------------------------------------------------------------------------------------------|
| Voltage | 230VAC | 230VAC | 230VAC |
| Output | - | 1200W Incandescent 500VA Fluorescent 1000VA Low Voltage (12VAC) Halogen Lamps 1200W Halogen (230VAC) 500VA Low Consumption Lamps 500VA Downlight Lamps 500VA LED | 2200W Incandescent 1200VA Fluorescent 2000VA Low Voltage (12VAC) Halogen Lamps 2200W Halogen (230VAC) 900VA Low Consumption Lamps 900VA Downlight Lamps 500VA LED |
| Range Angle | 30m / 360° at 3.5m(H) | 10m / 360° at 2.5m(H) | 30m / 360° at 12m(H) |
| Size (mm) | Ø140 x 68 | Ø76 x 68.5 | Ø140 x 68 |
| Light on Timer | 10s - 30min | 10s-30min Twilight mode (On<60 lux, Off>400 lux) | 10s-30min |
| Lux | 10 - 2000 lux | 100 lux - 2000 lux | 10-1000 lux |

Accessories

LIGHTING

MICROWAVE MOTION SENSORS



Small size allows unit to be mounted inside the light fitting.



Can be surface mounted or hidden in ceiling. Very sensitive.



Fixed 5.8GHz

| Code | JQ-25 | ECOMAT | ES-M12 |
|----------------|-----------------------------------------------------------|-----------------------------------------------------------|-----------------------------------|
| Volts | 220-240VAC | 230VAC | 230VAC |
| Output | 1200W Incandescent 500W Fluorescent 500W LV Halogen | 1000W Incandescent 500W Fluorescent 500W LV Halogen | 1200W Max |
| Range/ angle | 1-8m/ 360°, 160° | 6m/270° at 1.7m(H) | 10m / 360° |
| Size (mm) | 75 x 41 x 43 | 116 x 78 x 42 | Ø98 x 56mm / cutout Ø76mm |
| Light On Timer | 8sec-10min | 3s - 30min | 10s - 1, 5, 10, 15, 20, 25, 30min |
| Lux | < 5 Lux - 2000lux | 0.5 - 2000lux | 10, 20, 50, 100, 200, 300, 500lux |

RECESSED PIR & MICROWAVE SENSORS IP20

Input Voltage:
220-240VAC

Fixed PIR Sensor

Tiltable



| Code | ES-P14 | ES-P17A | ES-P17B | ES-P17C | ES-P27B |
|--------------------|------------------|------------------|------------------|-----------------------------------------------|------------------|
| Detection Angle | 360° | 360° | 360° | 360° | 360° |
| Detection Distance | 6m Max | 6m Max | 6m Max | 2-20m | 6m + |
| Load | 500W Max | 1200W Max | 1200W Max | 2000W (Incandescent) 1000W (Energy Saving) | 1200W Max |
| Time Min/Max | 10sec-7min | 10sec-7min | 10sec-7min | 10sec-7min Adjustable | 10sec-7min |
| Lux Min/Max | <10lux - 2000lux | <10lux - 2000lux | <10lux - 2000lux | <10lux - 2000lux Adjustable | <10lux - 2000lux |
| Dimensions | Ø50 x 66mm | Ø76 x 76mm | Ø100 x 76mm | Ø110 x 90mm | Ø85 x 59mm |
| Cutout | Ø40mm | Ø61.5mm | Ø76mm | Ø76mm | Ø68mm |

PIR MOTION & LIGHT SENSORS

Ceiling



Ceiling IP20



Flush



Fits standard 4x2 boxes

Wall IP44



| Code | ST24 | OS-460 | OS-472B | OS-472B-A | F4000 |
|----------------|--------------------------------------------------------------------------------------------------------------|------------------------------------------------------------------------------------|---------------------------------------------------------------------------------------------------------|-------------------------|------------------------------------------------------|
| Volts | 220-240VAC | 220-240VAC | 220-240VAC | | 220-240VAC |
| Output | 800W Incandescent Lamp 200W Low Voltage or Fluorescent Lamp | 1200W Incandescent | 800W Incandescent | 40-500W Incandescent | 1300W Incandescent Lights 300W Fluorescent Lights |
| Range/Angle | 360° | 11m/360° | Detection Angle 8m/180° | | Detection Angle 12m/180° |
| Size (mm) | Ø18 | 110 Ø x 32H | 115H x 73W | | 75 x 100 x 115 |
| Light On Timer | 5s to 8min | 10s to 7min | 10s - 7min | 10s - 7min | 10s to 7min |
| LUX | 10/2000lux | Adj. 3 - 2000 lux | <10-2000lux | Adj. <10-2000lux | Adj. 3 - 2000lux |
| | Passive Infra-Red sensor for automated control • Tiny sensor ball of 35mm Ø • Cut-out hole size 33mm Ø | Built-in photocell allows automatic operation at night and disable during daylight | • No blind spots • Can replace existing 1 way or 2 way switch • No neutral required for OS-472B-A | | • Complete with wall bracket |

PIR MOTION & LIGHT SENSORS

| | Flush | Surface - Flush | Surface |
|----------------|------------------------------------------------------------------------------------------------------------------------------------------|----------------------------------------------------|------------------------------------------------------------------------------------------------------------------------------|
| | | | |
| Code | OS-465 | FL380 | OS-462 |
| Volts | 220-240VAC | 220-240VAC | 220-240VAC |
| Output | Two loads: L' = 10A for incandescent T1-T2=10A max voltage free contact | 2000W Incandescent 1000W ESL | Two loads: L' = 10A max T1-T2=10A max voltage free contact |
| Range/Angle | 6m/360° at 2.4m (H) | 12m/360° at 4m (H) | 6m/360° at 2.4m (H) |
| Size (mm) | 80Ø x 51 / 110 x 53 x 30 | 124Ø x 82 | 113Ø x 39 |
| Light On Timer | L': 6s - 12min, T1-T2:10s - 30min | 10s-7min | L': 6s - 12min, T1-T2:10s - 30min |
| LUX | Fully adjustable Flush mount in ceiling. Dual load for light & ventilation. One additional sensor extendable. Code: OS-465S | <10 - 2000lux 3 x Detector for High sensitivity | Fully adjustable Plug in terminal block for easy installation. Dual load switching 4 element sensor for high sensitivity. |

| | Ceiling or wall IP45 | Ceiling or wall IP44 | | | |
|----------------|---------------------------------------------------------------------------------|------------------------------------------|---------------------------|------------------------------------|----------------------------------|
| | | | | | |
| | | | | | |
| Code | OS-181C | JQ26 230VAC | JQ26 12VDC | JQ701 | JQ43 |
| Volts | 230VAC | 220-240VAC | 12VDC | 220-240VAC | 220-240VAC |
| Output | 1840W Incandescent 1000W HV Halogen 300VA LV Halogen 400VA Fluorescent | 1100W Incandescent Load | 120W Incandescent Load | 600W Incandescent load | 150W Incandescent load |
| Range/Angle | 10m/270° at 2.5m(H) | 12m/180° at 2m(H) | | 6m ± 2m/ 360° | 6m ± 2m/ 360° |
| Size (mm) | 129 x 80 x 63 | 220 x 86 x 55 | | 85L x Ø73 | 64L x Ø45 |
| Light On Timer | 6s - 10min | 8s - 6min | | 8s - 6min | 5s - 8min |
| LUX | 5lux-2000lux | 2 lux - Daylight | | 3 lux - Daylight | 10 lux - 2000 lux |
| | Can be fitted to wall or ceiling or a corner. Waterproof. Test function. | Fully weather proof and easy to install. | | Easy to mount. Cut-out: Ø56.5mm | Easy to mount. Cut-out: Ø40mm |

AIR CONDITONER OCCUPANCY SENSOR

Reduce Energy Costs by up to 80%

EcoSense copies the "off" signal from the A/C remote controller, thereby ensuring the A/C goes through its correct shut down procedure



ECO 2000/4001



ECO-RC



ECO-WD



ECO-PS

Eco 2000

| Code | ECOS-2000 |
|----------------|-----------------------------------------------------------------------------------------------------------------------------------------------------------------------|
| Supply Voltage | 5x AAA battery (no mains required) |
| Description | EcoSense 2000 will scan the room for occupancy, when no occupancy has been detected after a pre-set time delay. A signal will be transmitted to the A/C to switch off |

Eco 4001

| Code | ECOS-4001 |
|----------------|---------------------------------------------------------------------------------------------------------------------------------------------------------------------------------------------------------------------------------------------------------------------------------------|
| Supply Voltage | 110-230VAC |
| Description | Universally compatible with any A/C that can be operated by remote controller. This model is mains powered and can be fitted directly adjacent to your A/C unit, therefore no connecting cables will be visible. Compatible with wireless accessories to further increase efficiency. |

Accessories for ECOS-4001

| Code | Description |
|--------------------|-------------------------------------------------------------------------------------------|
| ECO-RC-PLUS | Intelligent remote control to limit temperature range |
| ECO-WD | Wireless door and window sensor - switch off the air conditioner if a door/window is open |
| ECO-PS | Wireless PIR sensor - for extending detection range |

REMOTE CONTROL MICROWAVE SENSOR / DIMMING FUNCTION IP65



MC054V-RC-A

Microwave Sensor - Parameters can be conveniently set by remote control or via dip settings | Automatic dimming when used in combination with 1-10V dimmable control gear | 1-10V interface can match up stand-alone daylight sensor **MS01** and achieve daylight harvesting

| | |
|--------------------|---------------------------------------------------------------------------------------------|
| Code | MC054V-RC-A |
| Rated Load | 400W @ 120VAC, 800W @ 220-277VAC (Inductive), 800W @ 120VAC, 1200W @ 220-277VAC (Resistive) |
| Detection Area | 5-7m @ 8m Mounting Height |
| Hold Time | 5s / 30s / 1min / 3min / 5min / 10min / 20min / 30min |
| Daylight Sensor | Dip Switch & Remote Control 5lux / 15lux / 30lux / 50lux / 100lux / 150lux / disable |
| Stand-by Period | 0s / 10s / 1min / 3min / 5min / 10min / 30min / + ∞ |
| Stand-by Dim Level | 10% / 20% / 30% / 50% |
| Mounting Height | 15m Max. |
| Motion Detection | 0.5 ~ 3m/s |
| Detection Angle | 150° (Wall Installation) 360° (Ceiling Installation) |
| Size | Ø72 x 59mm |

Remote Control - Works in conjunction with **MC054V-RC-A**

| | |
|-------------|-----------------------|
| Code | MH01 |
| Description | Remote Set-up Control |

Daylight Sensor / Photocell (for Daylight Harvesting) - Works in conjunction with **MC054V-RC-A**

| | |
|-------------------|---------------|
| Code | MS01 |
| Operating Voltage | 1 - 10VDC |
| Dimming Range | 10% - 100% |
| Mounting Height | 3 - 4m |
| Daylight Sensor | 100 - 1000lux |
| Size | Ø21.5 x 60mm |

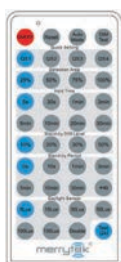

MH01



MS01

DAYLIGHT SWITCHES

| | | | | | | | | | |
|-----------------------|------------------------------|----------|------------------------------|------|-----------------------------------|---------|---------------------------|-------|---------------------------------------------------------------------------------------|
| | | | | | | | | | |
| Code | CA-22015 | CA-22006 | LA10 | LA16 | LA16-VDC | CDS-27A | LC-10 | LC-11 | CDS-15A |
| Light Off Delay Timer | - | - | 30sec | | 30sec | - | - | - | 60sec |
| Load | 15A | 6A | 10A | 16A | 16A @ 12-30VDC 1.5A @ 31-48VDC | 10A | 10A | 10A | 200W fluorescent 1000W incandescent |
| Lux | Fixed On 31.5 / Off 12.5 Lux | | Fixed On 60 Lux / Off 40 Lux | | | | On ≤ 20Lux / Off ≥ 80 Lux | | 200W fluorescent 1000W incandescent Adj. 5-300 Lux with LED Lux adj. indication |

Panel Fitted Daylight Switch

WITH BLUE TOOTH

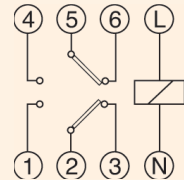

Astro Nova fits inside your distribution board. Enter in your co-ordinate or city & it will control your lights perfectly!

| | |
|-------------------------------------|----------------------------|
| Code | ASTRO NOVA |
| Accessory (Bluetooth Dongle) | OB709971 |
| Power Supply | 230VAC (6VA) |
| Switching Capacity | 16(10)A/250V AC 2C/O |
| Operating Accuracy | ±1sec/day at 23°C |
| Switching Accuracy | Better than 1 second |
| Battery Back-up | 10 years (Lithium battery) |
| Memory Spaces | 22 |
| Auto change summer/winter | Yes |
| Max Recommended Load | |
| Incandescent | 3000W |
| Non-compensated Fluorescent | 1200W |

OR1

Daylight Switch IP65



Size 95(D) x 32(W) x 46(H) mm

| | |
|-------------|----------------------------|
| Code | MS15 |
| Timer | 20sec |
| Load | 16A |
| Lux | Fixed On 60Lux / Off 40Lux |

Mini Daylight Switch



| | | |
|-------------|-------------|---------------|
| Code | JQ45 | JQGM01 |
| Timer | - | - |
| Load | 100W | 32W |
| Lux | < 10 Lux | < 10 Lux |

DC Daylight Switch



| | |
|-------------|----------------------------|
| Code | LR5 12VDC |
| Timer | - |
| Load | 6A |
| Lux | Fixed On 60Lux / Off 40Lux |

Accessories

LIGHTING

DIMMERS

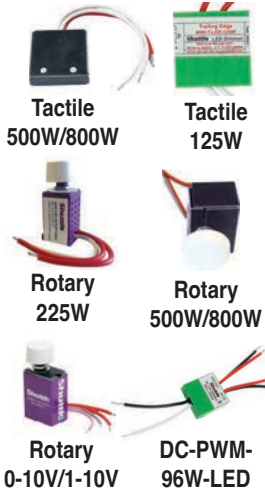

Shuttle Dimmers & Controllers - LED Dimmers with no Minimum Load/Under Voltage, High Frequency AC Transient & Surge Protection | Fits in Standard 4 x 2 Boxes | Create your own Dimmer with your choice of Plates | Trailing or leading Edge Dimming Method

| Dimming Method | | Universal Dimming (Leading & Trailing) Default Trailing | | | NEW PWM 0-10V / 1-10V | NEW DC PWM 9-48VDC |
|----------------|-------|---------------------------------------------------------|--------------|--------------|------------------------------|---------------------------|
| Watts | Amps | Tactile Code | Rotary Code | Tactile Code | Rotary Code | Bell Press Code |
| 96W | 2-10A | - | - | - | - | DC-PWM-96W-LED |
| 125W | 0.55A | DM-125W-LED | - | - | - | - |
| 225W | 1A | - | DMR-225W-LED | - | - | - |
| 500W | 2.2A | DM-500W-LED | DMR-500W-LED | LDM-500W-LED | - | - |
| 800W | 3.6A | DM-800W-LED | DMR-800W-LED | - | - | - |
| 1800VA | 10A | - | - | - | SDIMR-1-10V-1800VA | - |

Note: Please refer to Shuttle Compatibility list to confirm max number of lamps per dimmer | www.shuttlelighting.com

| Code | Description |
|--------|------------------------------------------------------------------------|
| DM-MZC | Allows co-ordinated or independant control of multiple tactile dimmers |

**UNI-
VERSAL**



Universal Dimmer - Compatible with all types of lamps except constant power lamps | Dimmer control bell press & digital control

| Code | DIM-CG-100 |
|---------------|--------------------------------------------------|
| Input Voltage | 230VAC |
| Dimming Range | 100% |
| Max. Load | 5-100W |
| Load Type | Fluorescent / LED / Halogen / CFL / Incandescent |
| Size (mm) | 50 x 50 |

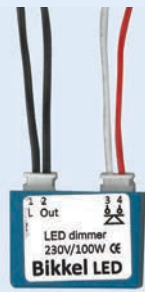

Compact Universal Dimmer Easy to turn a traditional switch into a intelligent LED dimmer | Bell Press or Rocker Switch

| Code | 890300 |
|---------------|-----------------|
| Input Voltage | 230VAC |
| Dimming Range | 100% (6% Steps) |
| Max. Load | 1-100W |
| Load Type | LED |
| Size (mm) | 36 x 36 x 12 |

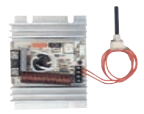

- CE Approved
- EMC Low Noise
- 470kΩ Pot supplied
- Incandescent or Halogen Lamps

Industrial Dimmer

| Code | Rating | Size (mm) |
|-------|------------|----------------|
| RTS38 | 230V 1400W | 115 x 105 x 65 |

ORBIS DIMMER & TIMERS

Accessories

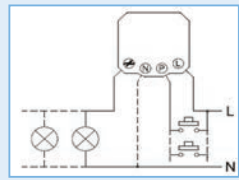

Orbis LED Dimmer - All Dimmable lamps except 12VDC LEDs operating with electromagnetic transformers | Suitable for Leading and Trailing Edge lamps | Neutral connection not required, only required for LED lamps that flicker or do not turn off | Suitable for 2-way switching

| Code | DIM-LED |
|-----------------|-------------------------------------------------------------|
| Input Voltage | 230VAC |
| Adjustment Type | Lamp 1 (Trailing Edge), Lamp 2 (Leading Edge) |
| Installation | Optional Neutral Connection (based on lamp characteristics) |
| Minimum Load | 3W |
| Maximum Load | 100VA (LED) |

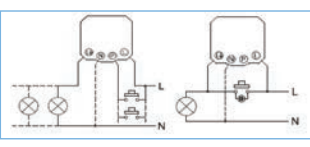

Orbis LED Timer - All lamp types, except LEDs operating with electromagnetic transformers or any type of fluorescent lights | Adjustable timing | Resettable | Additional push buttons can be fitted | Provides for fans and extractor control.

| Code | TEMPO-LED |
|---------------|-------------------------------------------------------------|
| Input Voltage | 230VAC |
| Timing Range | 15s - 15min |
| Installation | Optional Neutral Connection (based on lamp characteristics) |
| Minimum Load | 3W |
| Maximum Load | 100VA (LED), 50VA (Extractor Fan) |

LIGHTING

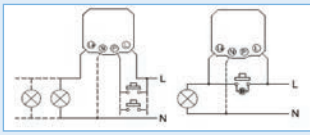

Orbis LED Timer & Dim - Initial 100% Lighting intensity during set time. Adjustable from 15s - 15min | After the set time has expired, light intensity is reduced to 25% maintaining a courtesy or safety level of light, either permanently or for a limited period of time (between 7min and 5min). Suitable for all dimmable lamps, except LEDs 12VDC operating with electromagnetic transformers.

| Code | TEMPO-LED-2N |
|------------------------|-------------------------------------------------------------|
| Input Voltage | 230VAC |
| Timing Range | 15s - 15min |
| Standby Lighting Timer | 1-5min / ∞ |
| Installation | Optional Neutral Connection (based on lamp characteristics) |
| Minimum Load | 3W |
| Maximum Load | 100VA (LED) |

DMX CONTROLLERS



| Code | DMX-512-12V | SRC-174 | SRC-144 |
|-------------|-----------------------------------------------------------------------------------------------------------------------------------------------------------------------------------------------------------------------------------------------------------------------------------------------------------------------------------------------------------------------------------------------------|---------------------------------------------------------------------------------------------------------------------------------------------------------------------------------------------------------------------------------------------------------------------------------------------------------------------------------------------------------------------------------------------------------------------------------------------------------------------------------------------------------------------|---------------------------------------------------------------------------------------------------------------------------------------------------------------------------------------------------------------------------------------------------------------------------------------------------------------------------------------------------------------------------------------------------------------------------------------------------------------------------------|
| Description | <ul style="list-style-type: none"> • 5 Channels, each channel 8A, 480W@12V, 960W@24V. • RJ45, 5 Pin XLR or 3 Pin XLR screen terminal selectable. • 1ch to 5 ch selectable • PWM Output resolution ratio 8 bits, 16 bits selectable. • PWM Frequency selectable from 500Hz - 9KHz. • Dimming curve gamma value selectable from 0.1 - 9.9 | <ul style="list-style-type: none"> • Allows you to program 12 scanners with 16DMX channels each, • 30 banks of 8 programmable scenes, 6 chases of 240 scenes using 8 channel sliders, a joystick, and other buttons. • With the ease of the joystick, you can accurately control the movement of a fixture. • In addition, two units can set up communication so that they can send or receive a complete file dump. • Fog machine output and activation button. | <ul style="list-style-type: none"> • 230VAC 52 Channel DMX Controller • Easy-to-use DMX controller for programming up to 9 intelligent lights • 52 Channels with 9 projector banks of 4 channels each • Scene, program and projector LED displays • 9 programs with up to 50 steps per program • Fade and Speed Control • Built-in microphone for sound-active mode • DC 9V power supply included |

DMX DECODERS

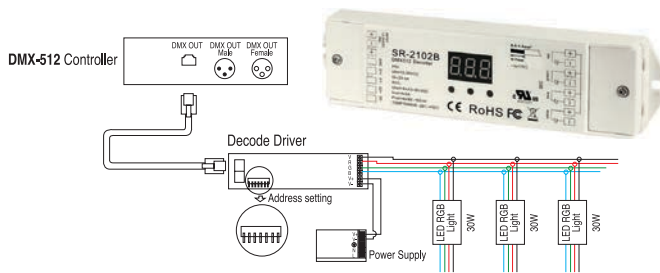

DMX 512 Decoder

| Code | IMG-DV512 |
|-----------------|------------------------------|
| Input Voltage | 12-36VDC |
| Load Current | 4ch, 5A |
| Load Power | 240W@12V, 480W@24V, 720W@36V |
| Output Signal | PWM |
| Decoding Signal | DMX512 |
| RGB Changes | 1 |
| Size (mm) | 130 x 40 x 35 |

BOX TYPE SWITCH MODE POWER SUPPLIES

Chassis Mount Supply Volts: 170 - 260VAC

- Output Accuracy: $\pm 2\%$
- Load Regulation: $\pm 2\%$
- Overload Protection
- Short Circuit Protection



BC1

15W

25W

40-200W

250W-350W

480W

| Watts | Code 5VDC | Amps | Code 12VDC | Amps | Code 24VDC | Amps | Code 48VDC | Amps | Size (mm) W x L x H |
|-------|------------|------|-------------|-------|-------------|------|-------------|-------|---------------------|
| 15W | SNP-15W/5 | 3A | SNP-15W/12 | 1.3A | — | — | — | — | 70 x 39 x 31 |
| 25W | SNP-25W/5 | 5A | SNP-25W/12 | 1.7A | SNP-25W/24 | 1.1A | — | — | 80 x 48 x 22 |
| 40W | — | — | SNP-40W/12 | 3.5A | SNP-40W/24 | 1.8A | — | — | 110 x 79 x 35 |
| 60W | SNP-60W/5 | 10A | SNP-60W/12 | 5A | SNP-60W/24 | 2.5A | SNP-60W/48 | 1.25A | 110 x 79 x 35 |
| 100W | SNP-100W/5 | 20A | SNP-100W/12 | 8.5A | SNP-100W/24 | 4.5A | — | — | 129 x 98 x 38 |
| 120W | — | — | SNP-120W/12 | 10A | SNP-120W/24 | 5A | SNP-120W/48 | 2.5A | 129 x 98 x 38 |
| 150W | — | — | SNP-150W/12 | 12.5A | SNP-150W/24 | 6.2A | — | — | 160 x 98 x 50 |
| 200W | — | — | SNP-200W/12 | 16.5A | SNP-200W/24 | 8.3A | SNP-200W/48 | 4.2A | 160 x 98 x 50 |
| 250W | — | — | SNP-250W/12 | 20A | SNP-250W/24 | 10A | SNP-250W/48 | 5A | 160 x 98 x 50 |
| 350W | — | — | SNP-350W/12 | 30A | SNP-350W/24 | 15A | SNP-350W/48 | 7.5A | 199 x 98 x 50 |
| 480W | — | — | — | — | SNP-480W/24 | 20A | — | — | 240 x 125 x 65 |

MEANWELL POWER SUPPLIES & DRIVERS

**3 Year
Warranty**



| Code | Output | | | Input | Size (mm) |
|-----------------------------------------|--------|------------|---------|--------------------------|----------------|
| | Power | DC Voltage | Current | Voltage | |
| Power Supplies - LRS Series IP30 | | | | | |
| LRS-35-12 | 35W | 12V | 3A | AC85-264V | 99 x 82 x 30 |
| LRS-35-24 | | 24V | 1.5A | | |
| LRS-50-12 | 50W | 12V | 4.2A | AC85-264V | 99 x 82 x 30 |
| LRS-50-24 | | 24V | 2.2A | | |
| LRS-75-12 | 75W | 12V | 6A | AC85-264V | 99 x 97 x 30 |
| LRS-75-24 | | 24V | 3.2A | | |
| LRS-100-12 | 100W | 12V | 8.5A | AC85-264V | 129 x 97 x 30 |
| LRS-100-24 | | 24V | 4.5A | | |
| LRS-150-12 | 150W | 12V | 12.5A | 85-132VAC/ 170-264VAC | 159 x 97 x 30 |
| LRS-150-24 | | 24V | 6.5A | | |
| LRS-200-12 | 200W | 12V | 17A | AC180-264V | 215 x 115 x 30 |
| LRS-200-24 | | 24V | 8.8A | | |
| LRS-350-12 | 350W | 12V | 29A | AC180-264V | 215 x 115 x 30 |
| LRS-350-24 | | 24V | 14.6A | | |

- Can be used in Class 1, Division 2 hazardous luminaires
- 1 - 10V or PWM Signal or resistance dimming
- Output Volts: 30 - 40V
- Output Volts Regulation: 0.5%

**5 Year
Warranty**



| | | | | | |
|------------------------------------------------------------------------|------|-----|-------|-----------|-------------------|
| Power Supplies - HLG Series - Built-in Active PFC Function IP67 | | | | | |
| HLG-40H-36A | 40W | 36V | 1.12A | AC90-305V | 171 x 61.5 x 368 |
| HLG-60H-36A | 60W | 36V | 1.7A | AC90-305V | 171 x 61.5 x 368 |
| HLG-80H-36A | 80W | 36V | 2.3A | AC90-305V | 195 x 61.5 x 368 |
| HLG-100H-36A | 100W | 36V | 2.65A | AC90-305V | 220 x 68 x 38.8 |
| HLG-120H-36A | 120W | 36V | 3.4A | AC90-305V | 220 x 68 x 38.8 |
| HLG-150H-36A | 150W | 36V | 4.2A | AC90-305V | 228 x 68 x 38.8 |
| HLG-185H-36A | 185W | 36V | 5.2A | AC90-305V | 228 x 68 x 38.8 |
| HLG-240H-36A | 240W | 36V | 6.7A | AC90-305V | 244.2 x 68 x 38.8 |
| HLG-320H-36A | 320W | 36V | 8.9A | AC90-305V | 252 x 90 x 43.8 |

**2 Year
Warranty**



| | | | | | |
|-----------------------------------------|-----|-----|-------|-----------|---------------|
| Power Supplies - APV Series IP30 | | | | | |
| APV-12-12 | 12W | 12V | 1A | AC90-264V | 77 x 40 x 29 |
| APV-12-24 | | 24V | 0.5A | | |
| APV-16-12 | 16W | 12V | 1.25A | AC90-264V | 77 x 40 x 29 |
| APV-16-24 | | 24V | 0.67A | | |
| APV-25-12 | 25W | 12V | 2.1A | AC90-264V | 84 x 57 x 295 |
| APV-25-24 | | 24V | 1.05A | | |
| APV-35-12 | 35W | 12V | 3A | AC90-264V | 84 x 57 x 295 |
| APV-35-24 | | 24V | 1.5A | | |

**2 Year
Warranty**



| | | | | | |
|-----------------------------------------|------|-----|-------|------------|-------------------|
| Power Supplies - LPV Series IP67 | | | | | |
| LPV-20-12 | 20W | 12V | 1.67A | AC90-264V | 118 x 35 x 26 |
| LPV-20-24 | | 24V | 0.84A | | |
| LPV-35-24 | 35W | 24V | 1.5A | AC90-264V | 148 x 40 x 30 |
| LPV-60-12 | 60W | 12V | 5A | AC90-264V | 162.5 x 42.5 x 32 |
| LPV-60-24 | | 24V | 2.5A | | |
| LPV-100-12 | 100W | 12V | 8.5A | AC90-264V | 190 x 52 x 37 |
| LPV-100-24 | | 24V | 4.2A | | |
| LPV-150-12 | 150W | 12V | 10A | AC180-305V | 191 x 63 x 37.5 |
| LPV-150-24 | | 24V | 6.3A | | |

LED CONSTANT VOLTAGE DRIVERS - VS

VS LIGHTING SOLUTIONS

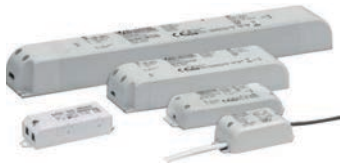

Easyline - 12V - IP20 | Electronic short circuit protection | Overload protection | Protection against "No-Load" operation | Protection class II

| Code | Watts | Current (A) | Output Volts | Dimensions (mm) |
|--------|-------|-------------|--------------|-----------------|
| 186621 | 60W | 5 | 12V | 180 x 45 x 19 |
| 186623 | 100W | 8.40 | 12V | 300 x 40 x 30 |

Comfort Line - 24V - IP20 | Electronic short circuit protection | Overload protection | Protection against "No-Load" operation | Protection class II

| Code | Watts | Current (A) | Output Volts | Dimensions (mm) |
|--------|-------|-------------|--------------|-----------------|
| 186625 | 60W | 2.5 | 24V | 153 x 41 x 32 |
| 186627 | 120W | 5 | 24V | 300 x 40 x 30 |

Easyline - 12V - IP67 | Electronic short circuit protection | Overload protection | Protection against "No-Load" operation | Protection class II

| Code | Watts | Current (A) | Output Volts | Dimensions (mm) |
|--------|-------|-------------|--------------|-----------------|
| 186629 | 75W | 6.25 | 12V | 155 x 50 x 32 |
| 186630 | 100W | 8.34 | 12V | 206 x 69 x 37 |
| 186631 | 150W | 12.5 | 12V | 206 x 69 x 37 |

Comfort Line - 24V - IP67 | Electronic short circuit protection | Overload protection | Protection against "No-Load" operation | Protection class II

| Code | Watts | Current (A) | Output Volts | Dimensions (mm) |
|--------|-------|-------------|--------------|-----------------|
| 186432 | 75W | 3.125 | 24V | 180 x 42 x 34 |
| 186433 | 100W | 4.2 | 24V | 206 x 68 x 37 |
| 186434 | 150W | 6.25 | 24V | 206 x 68 x 37 |

LED DRIVERS

IP68 - Supply Volts 170 - 250VAC | Short Circuit protection | Overload protection



PSU-2.5/12

| Code | Watts | Current (A) | Output Volts | Dimensions (mm) |
|-------------|-------|-------------|--------------|-----------------|
| PSU-1.5/12 | 20W | 1.5 | 12VDC | 162 x 27 x 21 |
| PSU-2.5/12 | 30W | 2.5 | 12VDC | 177 x 31 x 21 |
| PSU-5/12 | 60W | 5 | 12VDC | 133 x 62 x 38 |
| PSU-8.3/12 | 100W | 8.3 | 12VDC | 205 x 132 x 65 |
| PSU-12.5/12 | 150W | 12.5 | 12VDC | 205 x 117 x 58 |

LED Drivers - Constant Voltage



APT-MR16-12V

APT-AR111-15V

LHV100W24

| Code | Volts In | Volts Out | Current Out | Power | Size (mm) | For use with |
|---------------|------------|-----------|-------------|-------|---------------|--------------|
| APT-MR16-12V | 90-264VAC | 12VDC | 500mA | 6W | 51 x 42 x 23 | - |
| APT-AR111-15V | 90-264VAC | 15VDC | 800mA | 12W | 60 x 20 x 32 | LEDAR111 |
| LHV100W24 | 220-240VAC | 24VDC | 4.2A | 100W | 180 x 88 x 36 | - |

LED DIMMABLE DRIVER IP65

Constant Voltage



| Code | LEA-103C | LEA-105A | LEA-108A | LEA-112-A | LEA-115A |
|--------------------------|------------------------------------|---------------|---------------|---------------|---------------|
| Input Voltage | 100-277VAC | | | | |
| Constant Voltage | 12VDC | | | | |
| Output Power | 36W | 60W | 96W | 150W | 200W |
| Protection | Short Circuit, Overload, Over Heat | | | | |
| External Dimming Control | 0-100% (1-10V) | | | | |
| Size (mm) | 260 x 29 x 20 | 178 x 68 x 53 | 240 x 68 x 53 | 256 x 80 x 53 | 256 x 80 x 53 |

NEW
CONSTANT CURRENT DRIVERS - Tci IP20

Professional Dali 38 with Programmable Current (Dimmable) - Multi-power driver with dip switch for the selection of the output current | Dali 2 dimming (Compatible with standard Dali interfaces) and push switch dimming, 0/1% - 100%

| Code | Max Output | Current Output DC | Voltage Output DC | Dimensions |
|--------|------------|-------------------|-------------------|-------------------|
| 127490 | 16-38W | 300-1050mA | 10-54V | 146.5 x 44 x 30mm |

LED CONSTANT CURRENT DRIVERS - VS IP20

Easy Line LED Driver - Electronic Short-Circuit Protection | Over-Load Protection | Protection Against "No Load" Operation | Protection Class II | Secondary Side Switching of LED Modules is not allowed

| Code | Max Output | Current Output DC | Voltage Output DC | Dimensions (mm) |
|----------|------------|-------------------|-------------------|-----------------|
| VS186341 | 12.6W | 350mA | 8.4 - 36V | 123 x 45 x 19 |
| VS186431 | 20W | 350mA | 18 - 57V | 123 x 45 x 19 |
| VS186350 | 20.3W | 700mA | 8 - 29V | 123 x 45 x 19 |
| VS186502 | 47W | 1050mA | 27 - 45V | 171 x 41 x 32 |



Easy Line LED Driver - Dimmable - Dimmable with Phase Cutting Trailing Edge Dimmer | Minimum dimmer load has to be observed (150mA - 700mA / Max 6 - 36W) | Electronic Short-Circuit Protection | Over-Load Protection | Protection Against "No Load" Operation | Protection Class II

| Code | Max Output | Current Output DC | Voltage Output DC | Dimensions (mm) |
|--------|------------|-------------------|-------------------|-----------------|
| 186710 | 10W | 250mA | 20-40V | 115 x 45 x 25 |
| 186449 | 12W | 250mA | 27 - 48V | 123 x 45 x 19 |
| 186416 | 25W | 700mA | 22 - 36V | 153 x 41 x 32 |
| 186451 | 36W | 700mA | 32 - 52V | 171 x 41 x 32 |



Easy Line LED Driver - With Selectable Current - The required current output can be chosen by selecting the respective pin at the output terminal | Temporary Electronic Short-Circuit Protection | Protection Against "No Load" Operation | Protection Class II | Secondary Side Switching of LED Modules is not allowed

| Code | Max Output | Current Output DC | Voltage Output DC | Dimensions (mm) |
|--------|------------|-------------------|-------------------|-----------------|
| 186463 | 10W | 250mA | 17 - 40V | 103 x 67 x 31 |
| | 14W | 350mA | | |
| | 20W | 500mA | | |

NEW

Easy Line LED Driver - DIP Switch - Selectable current output by Dip Switch | Over load protection | Typical Applications: Shop Lighting, Office Lighting, Residential Lighting and Downlights

| Code | Max Output | Current Output DC | Voltage Output DC | Dimensions (mm) |
|--------|------------|-------------------|-------------------|-----------------|
| 187116 | 6.3W | 150mA | 10-42V | 97 x 43 x 30 |
| | 8.4W | 200mA | | |
| | 10.5W | 250mA | | |
| | 12.6W | 300mA | | |
| | 14.7W | 350mA | | |
| | 16.8W | 400mA | | |
| | 18.9W | 450mA | | |
| 187117 | 21W | 500mA | 28-40V | 97 x 43 x 26 |
| | 24W | 600mA | | |
| | 26W | 650mA | | |
| | 28W | 700mA | | |
| 187119 | 32W | 800mA | 28-40V | 97 x 43 x 26 |
| | 34W | 850mA | | |
| | 36W | 900mA | | |
| | 38W | 950mA | | |
| | 42W | 1050mA | | |

Comfort Line LED Driver - With Selectable Current - The required current output can be chosen by selecting the respective pin at the output terminal | Electronic Short-Circuit Protection | Over-Load Protection | Protection Against "No Load" Operation | Protection Class II.



| Code | Max Output | Current Output DC | Voltage Output DC | Dimensions (mm) |
|--------|------------|-------------------|-------------------|-----------------|
| 186444 | 40W | 350mA | 57 - 114V | 359 x 30 x 21 |
| | | 500mA | 40 - 80V | |
| | | 700mA | 28 - 57V | |
| 186443 | 79W | 350mA | 120 - 225V | 359 x 30 x 21 |
| | | 500mA | 80 - 170V | |
| | | 700mA | 60 - 120V | |

Accessories

LIGHTING

LED CONSTANT CURRENT DRIVERS - VS IP20

Primeline LED Driver - With Programmable Current (Dimmable) - The output current can be freely adjusted in 1mA steps between 350mA and 700mA (Factory Setting 350mA) | Dimming function is achieved by applying a pwm signal to the nominal current. Dimming Range: 1 to 100%. If no dimming interface is connected, brightness will stay at 100% | Dali and push button dimming is possible | Secondary side switching of LED modules is allowed (Hot wiring).



| Code | Max Output | Current Output DC Programmable | Voltage Output DC | Dimensions |
|-------------------|------------|--------------------------------|-------------------|---------------|
| 186465 | 24W | 350 - 700mA | 14 - 34V | 104 x 67 x 31 |
| 186572 | 37W | 350 - 700mA | 30 - 53V | 125 x 79 x 33 |
| NEW 186578 | 84W | 350 - 700mA | 60 - 220V | 359 x 30 x 21 |

LED Set - The Output Current can be Freely Adjusted Between 275mA and 700mA by Using a Resistor | Dimming function is achieved by applying a pwm signal to the nominal current. Dimming Range: 1 to 100%. | Dali and push button dimming is possible.



| | | | | |
|--------|-----|------------------------------------|-----------|---------------|
| 186565 | 42W | 275 - 700mA (350mA Factory Set) | 30 - 153V | 359 x 30 x 21 |
|--------|-----|------------------------------------|-----------|---------------|

LED CONSTANT CURRENT DRIVERS

LED Drivers - Constant Current



| Code | Volts In | Volts Out | Current Out | Power | No. of LEDs | Size (mm) |
|------------|------------|-------------|-------------|-------|-------------|----------------|
| LED-N12-3W | 100-250VAC | Up to 5VDC | 350mA | 3W | 1-2 pc x 3W | 65 x 35 x 23 |
| CLD-A3536 | 100-250VAC | Up to 36VDC | 350mA | 8W | 1-8pcs x 1W | 65 x 35 x 23 |
| CLD-A7006 | 100-250VAC | Up to 12VDC | 700mA | 6.5W | 1-2pcs x 3W | 65 x 35 x 23 |
| LED-N12-9W | 100-250VAC | Up to 21VDC | 700mA | 9W | 1-3pcs x 3W | 65 x 35 x 23 |
| CLD-B3503 | 100-250VAC | Up to 12VDC | 350mA | 3.5W | 1-3pcs x 1W | 67 x 37 x 27 |
| CLD-B3536 | 100-250VAC | Up to 36VDC | 350mA | 8W | 1-8pcs x 1W | 67 x 37 x 27 |
| CLD-B7006 | 100-250VAC | Up to 12VDC | 700mA | 6.5W | 1-2pcs x 3W | 67 x 37 x 27 |
| CLD-B7021 | 100-250VAC | Up to 21VDC | 700mA | 9W | 1-3pcs x 3W | 67 x 37 x 27 |
| LLVC12B-U | 100-240VAC | 13-21VDC | 700mA | 9-15W | 3-5pcs x 3W | 85 x 40.4 x 22 |

LED Floodlight Drivers - Constant Current



| Code | Watts | Size (mm) | Suitable for fitting |
|------------------|----------|---------------|-----------------------------|
| DRV-GY225TG-10W | 10W | 75 x 30 x 20 | GY225TG-10W |
| DRV-GY225TG-20W | 20W | 85 x 33 x 20 | GY225TG-20W |
| DRV-GY225TG-30W | 30W | 130 x 42 x 29 | GY225TG-30W & GY290TS-30W |
| DRV-GY290TG-40W | 40W | 130 x 42 x 30 | GY290TG-40W & GY290TS-40W |
| DRV-GY290TG-50W | 50W | 130 x 42 x 30 | GY290TG-50W & GY290TS-50W |
| DRV-GY370FG-60W | 60W | 160 x 42 x 29 | GY370FG-60W |
| DRV-GY370FG-70W | 70W | 160 x 42 x 29 | GY370FG-70W |
| DRV-GY570FG-80W | 80W | 160 x 42 x 29 | GY570FG-80W & GY470TG-80W |
| DRV-GY570FG-120W | 100-120W | 180 x 68 x 42 | GY570FG-120W & GY470TG-100W |

DIMMABLE ELECTRONIC TRANSFORMER

| Zero Minimum Load | Indoor IP20 | | | Outdoor IP56 | | |
|-----------------------|---------------|----------------|----------------|---------------|---------------|----------------|
| Code | ETZ-60 | ETZ-105 | ETZ-210 | ETW-60 | ETW-105 | ETW-210 |
| Input Voltage | 11.5VAC | | | | | |
| Nominal Input Current | 0.27A | 0.46A | 0.93A | 0.23A | 0.46A | 0.93A |
| Voltage Output | 11.5VAC | | | | | |
| Power Range | 0-60W | 0-105W | 0-210W | 0-60W | 0-105W | 0-210W |
| Current Output | 5.2A | 9.1A | 18.2A | 5.2A | 9.1A | 18.2A |
| Size (mm) | 95 x 41 x 27H | 108 x 44 x 33H | 167 x 52 x 38H | 73 x 41 x 27H | 81 x 44 x 33H | 167 x 52 x 38H |

LOW VOLTAGE ELECTRONIC TRANSFORMERS IP20

VS LIGHTING SOLUTIONS

Independent Electronic Converters - Liteline - For low voltage halogen incandescent lamps 12V | Protection against "no load" operation | protection against short-circuit: Electronic switch-off with automatic restart | Suitable for installation in furniture and on combustible surfaces | Dimming: Optional with phase-cutting leading-edge or phase-cutting trailing-edge dimmer

| Code | Wattage | Primary | Output | Size (mm) |
|-----------------|---------|----------|--------|---------------|
| VS186173 | 10-60W | 220-240V | 12VAC | 22 x 36 x 103 |
| VS186077 | 20-105W | 230-240V | 12VAC | 28 x 37 x 128 |

Electronic Transformers for Low Voltage Lamps - Dimmable



| Code | Lamp Watts | V-in | V-out | Size (mm) | Ta | Tc | Hz-in | Hz-out |
|----------------|------------|----------|-------|--------------|-------------|------|-------|--------|
| T-35ET | 35W | 230-240V | 11.2 | 90 x 40 x 18 | -25 – +50°C | 50°C | 50-60 | 34kHz |
| GF-105* | 35-105W | 230-240V | 11.4 | 146x44x23 | -25 – +40°C | 75°C | 50-60 | 34kHz |
| GF-150* | 35-150W | 230-240V | 11.4 | 166x41x31 | -25 – +40°C | 75°C | 50-60 | 34kHz |
| ET210 | 50-210W | 230-240V | 11.5 | 200x43x39 | -20 – +50°C | 70°C | 50-60 | 34kHz |

*Conformity: EN61046; EN55015; EN61547; EN61000 & EN50082-1. Surge withstanding capability is 3.75kV.

LOW VOLTAGE TRANSFORMERS

Iron Core Transformers 230V/12VAC complete with fuse. For Halogen Lamps.



| Code | Amps @12V | No of Lamps per Transformer | | |
|----------------|-----------|-----------------------------|-----|-----|
| | | 50W | 35W | 20W |
| L-50VA | 4.16A | 1 | 1 | 2 |
| L-100VA | 8.33A | 2 | 2 | 5 |
| L-150VA | 12.5A | 3 | 4 | 7 |
| L-200VA | 16.6A | 4 | 5 | 10 |
| L-250VA | 20.8A | 5 | 7 | 12 |
| L-300VA | 25A | 6 | 8 | 15 |
| L-350VA | 29.16A | 7 | 10 | 17 |
| L-400VA | 33.33A | 8 | 11 | 20 |
| L-500VA | 41.66A | 10 | 14 | 25 |

Iron Core Transformers

230/12VAC | Slim type



| Code | VA | Amps | Size L x W x H |
|----------------|-----|-------|----------------|
| TRF-105 | 105 | 8.75A | 239 x 43 x 35 |

Approved to EN61558-1-7 certified by TÜV

ELECTRONIC BALLASTS

Standard Ballasts

T8 Rapid Start



T8 Pre-Heat

| Single Tube Code T8 | Lamp Watts | Size (mm) L x H x W | Double Tube Code T8 | Lamp Watts | Size (mm) L x H x W |
|------------------------------------------------------------------------------------|------------|---------------------|---------------------|------------|---------------------|
| 220-240V Electronic Ballast for T8 lamp rapid start non-dimmable. EEI - A2. | | | | | |
| *L-18E | 18W | 225 x 28 x 30 | *L2-18E | 2 x 18W | 225 x 28 x 30 |
| *L-30E | 30W | 225 x 28 x 30 | *L2-30E | 2 x 30W | 225 x 28 x 30 |
| *L-36E | 36W | 225 x 28 x 30 | *L2-36E | 2 x 36W | 225 x 28 x 30 |
| *L-58E | 58W | 225 x 28 x 30 | *EBT-265 | 2 x 58W | 225 x 28 x 30 |

* For 110V add voltage to end of code eg: **L-18E/110VAC**

| T8 3 Lamp | | T8 3 or 4 Lamp | | | |
|-------------------------------------------------------------------------|---------|----------------|----------------|---------|---------------|
| EBT-336 | 3 x 36W | 365 x 28 x 38 | L4-18E | 4 x 18W | 305 x 28 x 38 |
| 180-264V Compact Ballast for T8 Lamp Pre-heat Start Non-Dimmable | | | | | |
| IC-36E | 36W | 365 x 28 x 30 | IC2-18E | 2 x 18W | 365 x 28 x 30 |
| IC-58E | 58W | 365 x 28 x 30 | IC2-36E | 2 x 36W | 425 x 28 x 36 |

ELECTRONIC BALLASTS

T5 Rapid Start



T5 Pre-Heat

220-240V Electronic Ballast for T5 lamp rapid start non-dimmable. EEI - A2.

| Single Tube Code | Lamp Watts | Size (mm) L x H x W | Double Tube Code T8 | Lamp Watts | Size (mm) L x H x W |
|------------------|------------|---------------------|---------------------|------------|---------------------|
| 5L-14E | 14W | 225 x 28 x 30 | 5L2-14E | 2 x 14W | 285 x 28 x 30 |
| 5L-21E | 21W | 225 x 28 x 30 | 5L2-21E | 2 x 21W | 285 x 28 x 30 |
| - | - | - | 5L2-28E | 2 x 28W | 285 x 28 x 30 |
| SIS114-35 | 14-35W | 360 x 30 x 26 | - | - | - |
| 5L-24E | 24W | 280 x 25 x 30 | 5L2-24E | 2 x 24W | 280 x 30 x 30 |
| 5L-35E | 35W | 280 x 30 x 30 | 5L2-35E | 2 x 35W | 280 x 30 x 30 |
| 5L-49E | 49W | 280 x 30 x 30 | 5L2-49E | 2 x 49W | 280 x 30 x 30 |
| 5L-54E | 54W | 280 x 30 x 30 | 5L2-54E | 2 x 54W | 280 x 25 x 30 |

220-240V Compact Ballast for T5 Lamp Pre-heat Start Non-Dimmable

| Single Tube Code | Lamp Watts | Size (mm) L x H x W | Double Tube Code | Lamp Watts | Size (mm) L x H x W |
|------------------|------------|---------------------|------------------|------------|---------------------|
| 5IC-24E | 24W | 365 x 28 x 30 | 5IC2-24E | 2 x 24W | 425 x 28 x 36 |
| - | - | - | 5IC2-28E | 2 x 28W | 425 x 28 x 36 |
| 5IC-54E | 54W | 425 x 28 x 30 | - | - | - |

Dimmable Ballasts for Fluorescent Lamps



220-240V Linear Electronic 1-100% Dimmable Ballast: 1-10V control 0.25mA - CFLs: EEI-A1

| Single Tube Code | Lamp Watts | Double Tube Code | Lamp Watts | Lamp Type | Size (mm) L x H x W |
|------------------|------------|------------------|--------------|-----------|---------------------|
| SD118-40 | 18 - 36W | SD218-40 | 2 x 18 - 36W | T8 | 360 x 30 x 26 |
| SD149 | 49W | - | - | T5 | 360 x 30 x 26 |

• Power factor: 0.98 • Ambient operating temperature (ta) 0°C - +50°C & max. case temperature (tc) 75°C.

• To be used in conjunction with dimmer module DS2F or EP1



Dimmer Module

| Code | Type of Control | Outputs | Max Power | Size (mm) |
|------|---------------------|---------|-----------|---------------|
| DS2F | Push Button Control | 2 Sets | 250VA | 118 x 40 x 25 |
| EP1 | Potentiometer | 1 Set | 250VA | - |

Maximum switching power: 250VA = max. 20 Ballasts synchronized simultaneously



220-240V Compact Electronic 2-100% Dimmable Ballast: 1-10V control 0.25mA - CFL's: EEI-A1*

| Single Code | Type | Watts | Double Code | Type | Watts | Size (mm) |
|-------------|----------|--------|-------------|----------|------------|----------------|
| TD118 | PLC/PLE | 18W | TD218 | PLC/PLE | 2 x 18W | 123 x 78 x 305 |
| TD126-42 | PLC/PLCE | 26-42W | TD226-42 | PLC/PLCE | 2 x 26-42W | 123 x 78 x 305 |

• Power factor: 0.98. • Ambient operating temperature (ta) 0°C - +50°C & max. case temperature (tc) 75°C. To be used in conjunction with dimmer module DS2F or EP1



220-240V Electronic Ballast for PLCE Lamps

| Single Code | Lamp Watts | Size (mm) L x H x W | Double Code | Lamp Watts | Size (mm) L x H x W |
|-------------|------------|---------------------|-------------|------------|---------------------|
| LP-13E | 7-13W | 102 x 30 x 67 | - | - | - |
| LP-18E | 18W | 102 x 30 x 67 | LP2-18E | 2 x 18W | 102 x 35 x 75 |
| LP-26E | 26W | 102 x 30 x 67 | LP2-26E | 2 x 26W | 102 x 35 x 75 |
| | | | LP2-42E | 2 x 42W | 102 x 35 x 75 |

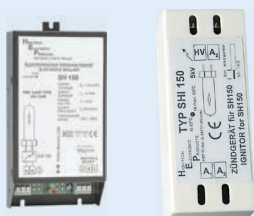

220-240V Digital Electronic Ballast for Metal Halide Lamps (HID)

| Code | Rated Current | Lamp Wattage | Starting V | Size (mm) |
|--------|---------------|--------------|------------|-----------------|
| SH35 | 0.18A | 35W | 3.5kV | 123 x 78 x 30.5 |
| SH70 | 0.36A | 70W | 4.5kV | 123 x 78 x 30.5 |
| SH150I | 0.70A | 150W | 4.5kV | 175.4 x 88 x 36 |
| SH150* | 0.70A | 150W | 4.5kV | 175.4 x 88 x 36 |

*For SH150 – Ballast with separate ignitor enables ballast placement 30m from lamps.

• Supply Voltage: 180-264VAC • Ambient temperature (ta) -15°C - +50°C & max. case temp. 75°C

VS COMPONENTS

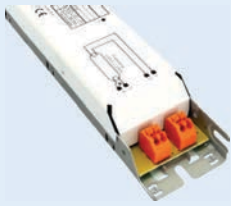

Electronic T8 Ballast - Warm Start - 220-240VAC

| Code | Wattage | Type | Base | Size (mm) |
|--------|-------------------|------|------|---------------|
| 188704 | 18W / 36W | T8 | G13 | 230 x 41 x 28 |
| 188705 | 2 x 18W / 36W | T8 | G13 | 230 x 41 x 28 |
| 188706 | 1 x 58W | T8 | G13 | 230 x 41 x 28 |
| 188707 | 2 x 58W | T8 | G13 | 230 x 41 x 28 |
| 188744 | 3 x 18W / 4 x 18W | T8 | G13 | 230 x 41 x 28 |



Electronic T5 Ballast - Warm Start - 220-240VAC

| | | | | |
|--------|------------------------------------------|----|----|---------------|
| 188921 | 1 x 14W / 1 x 21W / 1 x 28W / 1 x 35W | T5 | G5 | 230 x 30 x 21 |
| 188438 | 3 x 14W / 4 x 14W | T5 | G5 | 230 x 41 x 28 |
| 188142 | 1 x 54W | T5 | G5 | 359 x 30 x 21 |
| 188618 | 2 x 54W | T5 | G5 | 359 x 30 x 21 |
| 188144 | 1 x 80W | T5 | G5 | 359 x 30 x 21 |
| 188619 | 2 x 80W | T5 | G5 | 359 x 30 x 21 |



Electronic ballast for multiple wattage CFL Lamps - 220 / 240VAC

| Code | Wattage | Type | Base | Size (mm) |
|--------|---------|------------|----------------------------------------|---------------|
| 188700 | 18-40W | TC-DEL/TEL | 2G10/2G11 2G x 13 G24q-3/Gx24q-3 | 103 x 67 x 31 |



HPS / Metal Halide ballasts - 230 / 240VAC

| Code | Wattage | Amps | Size LxBxH | Capacitor Required | Lamp Type |
|-------------------|---------|-------------|-----------------|--------------------|-----------|
| 161367 | 35W | 0.53A | 108 x 66 x 53 | 6µF | HPS / MH |
| 161379 | 50W | 0.76A | 108 x 66 x 53 | 8µF | HPS |
| 571022 | 70W | 0.98A | 108 x 66 x 53 | 12µF | HPS / MH |
| 570964 | 100W | 1.20A | 112 x 86 x 36 | 12µF | HPS / MH |
| 571013 | 150W | 1.8A | 145 x 69 x 53 | 20µF | HPS / MH |
| 504109 | 250W | 3.00A | 108 x 66 x 53 | 32µF | HPS / MH |
| 178771 | 250W | 3.00A | 133 x 102 x 93 | 32µF | HPS / MH |
| 571054 | 400W | 4.45A | 148 x 135 x 62 | 45µF | HPS / MH |
| 533484 | 600W | 6.20A | 173 x 102 x 93 | 55µF | HPS |
| 528548 | 1000W | 10.3 / 9.5A | 203 x 102 x 92 | 100 / 85µF | HPS / MH |
| NEW 571046 | 1000W | 10.3 / 9.5A | 248 x 235 x 160 | 100 / 85µF | HPS / MH |
| 554304 | 2000W | 8.8A | 160 x 150 x 128 | 37µF | MH |
| 554306 | 2000W | 10.3A | 160 x 150 x 128 | 60µF | MH |



Mercury Vapour / Metal Halide Ballast - 230VAC

| | | | | | |
|-------------------|-------|-------|----------------|------|---------|
| 167304 | 80W | 0.80A | 108 x 66 x 53 | 8µF | MV |
| 570968 | 80W | 0.80A | 112 x 69 x 53 | 8µF | MV |
| 570969 | 125W | 1.15A | 112 x 86 x 36 | 10µF | MV |
| 167367 | 250W | 2.13A | 145 x 66 x 53 | 18µF | MV / MH |
| 570971 | 400W | 3.25A | 180 x 69 x 53 | 25µF | MV / MH |
| 528761 | 1000W | 7.50A | 173 x 102 x 92 | 60µF | MV |
| NEW 571255 | 1000W | 7.50A | 173 x 104 x 91 | 60µF | MV / MH |



Ignitors

| Code | Wattage | Size LxBxH | Type | Pick V |
|--------|-----------|----------------|---------------------|--------|
| 140597 | 35-400W | 78 x 34 x 27mm | Superimposed 3 Wire | 4-5kV |
| 140430 | 250-1000W | Ø50 x 80mm | Superimposed 3 Wire | 4-5kV |
| 140497 | 2000W | Ø50 x 98mm | Superimposed 3 Wire | 4-5kV |



Standard Magnetic Ballast - 230VAC

| Code | Output Wattage | Type | Base | Size (mm) |
|--------|----------------|-------------|--------------------|---------------|
| 508183 | 18W | TC-F / TC-L | 2G10 / 2G11 / 2G13 | 150 x 41 x 28 |
| | 18W / 20W | T8 / T12 | G13 | |
| 529029 | 36W | TC-F / TC-L | 2G10 / 2G11 | 150 x 41 x 28 |
| | 36W / 40W | T8 / T12 | G13 | |
| 508186 | 58W | T-U | 2G13 | 190 x 41 x 28 |
| | 58W / 65W | T8 / T12 | G13 | |

NEW

TCI COMPONENTS

Electronic T8 Ballast - Preheat - 220-240VAC / EEI = A2



| Code | Wattage | Type | Base | Size (mm) |
|----------------|---------|------|------|---------------|
| BLT-118 | 1 x 18W | T8 | G13 | 280 x 30 x 29 |
| BLT-136 | 1 x 36W | T8 | G13 | 280 x 30 x 29 |
| BLT-158 | 1 x 58W | T8 | G13 | 280 x 30 x 29 |
| BLT-218 | 2 x 18W | T8 | G13 | 280 x 30 x 29 |
| BLT-236 | 2 x 36W | T8 | G13 | 280 x 30 x 29 |
| BLT-258 | 2 x 58W | T8 | G13 | 280 x 30 x 29 |

Electronic CFL Ballast - Preheat - 220-240VAC / EEI = A2



| Code | Wattage | Type | Base | Size (mm) |
|----------------|--------------|--------|-----------|--------------|
| BLC-116 | 1 x 5-7-9-11 | TC-S/E | 2G7 | 80 x 41 x 18 |
| | 1 x 10 | TC-D/E | G24q-1 | |
| | 1 x 10-16 | TC-DD | Gr10q | |
| BLC-121 | 1 x 13-18 | TC-D/E | G24q-1/2 | 80 x 41 x 18 |
| | 1 x 13-18 | TC-T/E | Gx24q-1/2 | |
| BLC-124 | 1 x 18-24 | TC-L | 2G11 | 80 x 41 x 18 |
| | 1 x 18-24 | TC-F | 2G10 | |
| | 1 x 22 | T-R5 | 2Gx13 | |
| BLC-126 | 1 x 24 | TC-L | 2G11 | 80 x 41 x 18 |
| | 1 x 24 | TC-F | 2G10 | |
| | 1 x 26 | TC-D/E | G24q-3 | |
| | 1 x 26 | TC-T/E | Gx24q-3 | |
| | 1 x 22 | T-R5 | 2Gx13 | |

MAGNETIC BALLASTS



Ballast for Mercury Vapour Lamps 230V 50Hz

| Code | Watts | Amps | Size (L x W x H) | Capacitor Required |
|------------|-------|-------|------------------|--------------------|
| Q80-612.2 | 80W | 0.8A | 112 x 66 x 53 | 8 μ F |
| Q125-613.2 | 125W | 1.15A | 112 x 66 x 53 | 12 μ F |

For 250W & 400W, See **M250.2** and **M400.2** below.



High Pressure Sodium (HPS) and Metal Halide (MH) Lamps 230V 50Hz

| Code | Watts | Amps | Size L x W x H | *Capacitor Required | For Lamp Type |
|---------|-------|------|----------------|---------------------|---------------|
| SM70.2 | 70 | 1A | 112 x 66 x 53 | 12 μ F | HPS/MH |
| SM100.2 | 100 | 1.2A | 144 x 66 x 53 | 12 μ F | HPS |
| SM250.2 | 250 | 3.0A | 180 x 66 x 53 | 32 μ F | HPS/MH |
| SM400.2 | 400 | 4.6A | 185 x 75 x 65 | 50 μ F | HPS/MH |

For Metal Halide and Mercury Vapour Lamps

| | | | | | |
|--------|------|------------|----------------|-------------|-------|
| M250.2 | 250 | 2.13A | 144 x 66 x 53 | 18 μ F | MH/MV |
| M400.2 | 400 | 3.4A/3.25A | 180 x 66 x 53 | 30 μ F | MH/MV |
| B1000S | 1000 | 10.3A | 203 x 102 x 92 | 100 μ F | HPS |

Ballast for Tubular or Compact Fluorescent Lamps 230V 50Hz.

| Code | Lamp | Watts | Size L x W x H |
|----------|------|----------------|-----------------|
| FL20 | T8 | 18-26W | 155 x 41 x 28mm |
| FL40 | T8 | 1x36W or 2x18W | 155 x 41 x 28mm |
| FL65 | T8 | 58-65W | 195 x 41 x 28mm |
| FC9 | PL | 7/9/11W | 100 x 41 x 26mm |
| CB-508 | PL | 13/18W | 95 x 41 x 28mm |
| CB800-26 | PL | 26W | 155 x 41 x 28mm |
| CB800-42 | PL | 42W | 155 x 41 x 28mm |

Electronic Ballast Lamp Holder

| | | | |
|----------|-------------------------|-------|-------------------|
| DEB-G182 | PLC, PLCE (G24q, GX24q) | 9-18W | ϕ 40 x 50 mm |
|----------|-------------------------|-------|-------------------|

Ballast for PL-Lamp c/w Holder

| | | | |
|--------|-----|--|-----------------|
| CLB318 | PLC | | 155 x 41 x 18mm |
|--------|-----|--|-----------------|

Control (Plastic) Box for PL-Lamp

| Code Magnetic | Watts | Size | Code Electronic |
|---------------|------------------------|------------------|-----------------|
| CBP-213 | 2 x 13W c/w 3.25MF cap | 254 x 52 x 100mm | EBP-214 |
| CBP-218 | 2 x 18W c/w 4MF cap | 254 x 52 x 100mm | EBP-218 |
| CBP-226 | 2 x 26W c/w 8MF cap | 254 x 52 x 100mm | EBP-226 |



IGNITOR / STARTERS

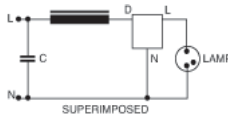

CD-7

Ignitors for High Pressure Sodium and Metal Halide Lamps 220-240V 50/60Hz

| Code | Type | Watts | Pick V. | Amps | $^{\circ}$ C | Size L x ϕ |
|-------|---------------------|----------|---------|------|--------------|-----------------|
| CD-7 | Superimposed 3 Wire | 35-400 | 3-4.5kV | 1.8 | 105 | 90 x 35mm |
| CD-10 | Superimposed 3 Wire | 600-1000 | 3-4.5kV | 1.8 | 105 | 90 x 35mm |

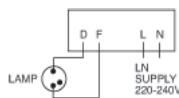

UR150.20

Enclosed Control Gear C/w Ignitor, Capacitor and Ballast for HPS & MH

| | | | |
|---------------------------------|-----|-----|------------------|
| UR70.20 | 70 | 1 | 245 x 120 x 70mm |
| UR100.20 | 100 | 1.2 | 245 x 120 x 70mm |
| UR150.20 | 150 | 1.8 | 245 x 120 x 70mm |
| NB150GB (for metal halide only) | 150 | 1.8 | 245 x 120 x 70mm |

Report No. EMI/2316/Y1022A & B
2330/YE1457A & B

FST2 & 4



Linear Fluorescent Lamp Starters

| Code | Wattage | Voltage | Description |
|------|---------|----------|------------------------------------------------------------|
| FST2 | 4-25W | 220-240V | To be used with 2 x 18W Tube, single 40W ballast luminaire |
| FST4 | 4-85W | 220-240V | For use with 3ft, 4ft and 5ft tubes |

EMERGENCY KIT WITH STANDBY FEATURE

Input Voltage: 230VAC

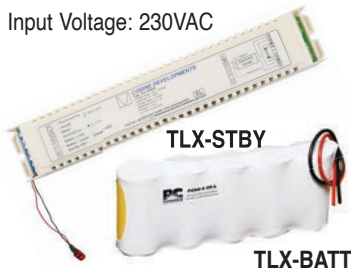

The Emergency Control unit has a standby inhibit function to conserve battery power during power failure I Maintained and Non-Maintained

Emergency Kit with Standby Power - Battery to be Ordered Separately

| Code | Fluorecent Lamp Wattage | Emergency Duration | Dimensions (mm) |
|----------|-------------------------|--------------------|-----------------|
| TLX-STBY | 6 - 80W | 20% 1hr | 247 x 45 x 35 |

Battery - Nickle-Cadmium

| Code | Battery Capacity | Voltage | Dimensions (mm) |
|----------|------------------|---------|-----------------|
| TLX-BATT | 5 x 2Ah | 6V | 110 x 46 x 26 |

220-240V Electronic Emergency Inverters for use with Electromagnetic and Electronic Ballasts



| Code | | Lamp | | Size L x W x H | Spare Battery | Battery | | Output Lumen |
|----------|--------|---------------|--------|----------------|---------------|---------|----|--------------|
| 1H | 3H | Type | Watts | | | Volts | Ah | |
| 1A186018 | - | T8/T5/G23 | 18-65W | 190x40x35 | 5KRH23/43 | 6V | 4 | 38%-10% |
| - | RP0701 | G24/Gx24/2G11 | 18-65W | 175x41x35 | 802027 | 3.6V | 4 | 38%-10% |

*Automatically cycles the battery every 4 weeks. Includes battery and LED battery indicator. Provides power to all fluorecent lamps during power failure to provide a suitable level of illumination for evacuation. Can be used for maintained and non-maintained illumination conversions.

Emergency Lighting Modules for TC and T Lamps - 6 to 80W with Self-Diagnosis function I Battery charging Time 24h I Designed for installation in LED Luminaires for Safety Lighting for rescue routes and Extremely hazardous work places



| Code | | Lamp | | Size L x W | NiCd Battery | Battery | | Output Lumens |
|--------|--------|------|-------|---------------|--------------|---------|-------|---------------|
| 1H | 3H | TYPE | Watts | | | Volts | Ah | |
| 188792 | - | TC&T | 6-80W | 210 x 31 x 21 | 188823 | 4.8V | 1.8Ah | 3.7-43% |
| - | 188793 | TC&T | 6-80W | 210 x 31 x 21 | 188824 | 4.8V | 4.5Ah | 3.7-43% |

Accessories

| Code | Description |
|--------|--------------------------------------|
| 188827 | Holder for 1H Rechargeable Batteries |
| 188828 | Holder for 3H Rechargeable Batteries |

220-240V Combined Electronic Ballast and Emergency Inverter



| Code | | Lamp | | Output Lumen | Size L x W x H | Spare Battery | | | | | |
|-----------|-----------|------|-------|--------------|----------------|---------------|-----|-----|-----------|-----|----|
| 1H | 3H | Type | Watts | | | 1H | V | Ah | 3H | V | Ah |
| DT-18E-1H | DT-18E-3H | T8 | 18W | 38% | 288x30x40 | 3KRH23/43 | 3.6 | 1.8 | 3KRH33/62 | 3.6 | 4 |
| IT-36E-1H | IT-36E-3H | T8 | 36W | 18% | 425x30x38 | 4KRH23/43 | 4.8 | 1.8 | 4KRH33/62 | 4.8 | 4 |
| IT-58E-1H | IT-58E-3H | T8 | 58W | 10% | 425x30x38 | 5KRH23/43 | 6 | 1.8 | 5KRH33/62 | 6 | 4 |
| IT-54E-1H | IT-54E-3H | T5 | 54W | 10% | 425x30x38 | 5KRH23/43 | 6 | 1.8 | 5KRH33/62 | 6 | 4 |

220-240V Emergency Inverters for PL 26W lamps



| Code | Description |
|----------|------------------------------------------------------------|
| HT-PL26W | 3 hour emergency duration kit for PL26W lamp (single lamp) |

LED EMERGENCY DRIVER



Universal LED Driver

Input Voltage: 85-265V I Battery Cycle Times ≥ 500 I To be used with External LED Driver

| Code | Emergency Luminous Flux | LED Lamp Power | Output | Battery | Emergency | Size (mm) |
|---------------|-------------------------|----------------|-----------|-----------------------------|-----------|----------------|
| FAT-LED-F1D | 2-4W | 3-20W | To driver | 18650 Li-ion 3.7V; 2200mAh | 3 hours | 68 x 38 x 20 |
| FAT-LED-F1A | 4W Fixed | 3-40W | To driver | 18650 Li-ion 3.7V; 2400mAh | ≥ 2 hours | 110 x 55 x 21 |
| FAT-LED-E50W | 100% | 3-50W | 230VAC | 18650 Li-ion 18.5V; 5200mAh | ≥ 90 min | 230 x 105 x 50 |
| FAT-LED-E100W | 100% | 50-100W | 230VAC | 18650 Li-ion 18.5V; 7200mAh | ≥ 90 min | 310 x 105 x 50 |

Emergency Inverter

Input Voltage: 230VAC I Maintained & Non-Maintained I Not limited to a specific number of cells for a given inverter I Battery not included I Compatible with **IBG-LED-60W** & **IBG-LED-100W** (page 49)



| Code | Nominal Voltage | Nominal Current | Lamp Power | Battery | Emergency Time | Size (mm) |
|-------------|-----------------|-----------------|------------|------------------|----------------|---------------|
| ECLAT-39410 | 24VDC | 2950mA | 60-70W | 18V (3x6V 4.5Ah) | 1hr 100% | 31 x 40 x 280 |
| ECLAT-39482 | 24VDC | 2500mA | 90-120W | 24V (4x6V 4.5Ah) | 1hr 100% | 31 x 40 x 280 |

EMERGENCY ILLUMINATION



LED Slim Light - Maintained / Non-Maintained (Jumper Selectable) - **IP20** | 230 VAC

| Codes | Consumption | Battery Ni-Cd | Duration | Lamp | Light Output | Weight |
|-------------------|-------------|---------------|----------|----------|--------------|--------|
| GR-8/12LED | 3VA | 3.6V / 0.6Ah | 1.5hrs | 12 LED's | 35lm / 85lm | 430g |
| GR-9/12LED | 3.5VA | 3.6V / 1Ah | 3hrs | 12 LED's | 32lm / 85lm | 460g |

• Size (mm): 246(L) x 76(W) x 45(D)

Additional Self-Adhesive Legends - To be ordered separately



Self-adhesive legends included in pack. Suitable for each direction.

S-00800/S65L

S-00800/S65R

S-00800/S65D



Professional Light

Professional Light - Emergency Luminaires 230V IP20

| Code | Consumption | Battery Ni-Cd | Duration | Lamp | Light Output | Weight |
|-------------------------------------|-------------|---------------|----------|--------|--------------|--------|
| Fluorescent - Non-Maintained | | | | | | |
| GR-110 | 3VA | 2.4V / 1.5Ah | 90min | 8W | 85lm | 770g |
| GR-112 | 3VA | 2.4V / 3Ah | 3hrs | 8W | 85lm | 870g |
| GR112-2 | 3VA | 2.4V / 3Ah | 3hrs | 2 x 8W | 85lm | 870g |

Fluorescent - Maintained

| | | | | | | |
|---------------|------|--------------|-------|----|------------|------|
| GR-115 | 23VA | 2.4V / 1.5Ah | 90min | 8W | 315 / 85lm | 810g |
| GR-116 | 24VA | 2.4V / 3Ah | 3hrs | 8W | 315 / 85lm | 920g |

LED - Maintained & Non-Maintained (Jumper Selectable)

| | | | | | | |
|-------------------|-----|---------------|-------|--------|-------|------|
| GR-110-LED | 3VA | 3.6V / 600mAh | 90min | 3W LED | 105lm | 590g |
| GR-112-LED | 3VA | 3.6V / 1.5Ah | 3hrs | 3W LED | 105lm | 670g |

• c/w Easy Base - for easy installation
• Spare Lamp **FLT5-8**

Accessories

| Code | Description |
|---------------|-----------------------------------------------------------------|
| A-1013 | Recess mounting base for wall or suspended ceiling installation |



LED



A-1013

Additional Self-Adhesive Legends - To be ordered separately



Self-adhesive legends included in pack. Suitable for each direction.

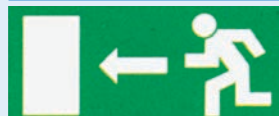

S-11100/S65L



S-11100/S65R



S-11100/S65D



Double Easy Light - Emergency Luminaires 230V IP42

| Code | Consumption | Battery Ni-Cd | Duration | Lamp | Light Output | Weight |
|-------------------------------------|-------------|---------------|----------|------|--------------|--------|
| Fluorescent - Non-Maintained | | | | | | |
| GR-380 | 3VA | 2.4V / 1.5Ah | 90min | 8W | 85lm | 900g |
| GR-382 | 4VA | 2.4V / 3Ah | 3hrs | 8W | 85lm | 1000g |

LED - Non-Maintained

| | | | | | | |
|-----------------|-----|--------------|--------|------|-------|-------|
| GR-391/L | 3VA | 3.6V / 1.5Ah | 1.5hrs | 3W | 220lm | 900g |
| GR-393/L | 3VA | 3.6V / 3Ah | 3hrs | 4.3W | 220lm | 1000g |

• Dimensions: 350(L) x 134(W) x 60(H)mm
• Can be mounted onto the ceiling or wall, using special mounting accessories, which are included.
• Spare Lamp **FLT5-8**

Additional Self-Adhesive Legends - To be ordered separately

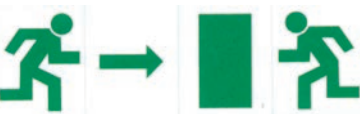

Self-adhesive legends included in pack. Suitable for each direction.



S-31100/S65L



S-31100/S65R



S-31100/S65D

EMERGENCY ILLUMINATION



LED Weather Light - Emergency Luminares - Non-Maintained - IP65 | 230V

| Codes | Consumption | Battery Ni-Cd | Duration | Lamp | Light Output | Weight |
|-------------|-------------|---------------|----------|------|--------------|--------|
| GR-1935/15L | 3VA | 3.6V / 600mAh | 1.5hrs | 2.5W | 105lm | 1010g |
| GR-1936/15L | 4VA | 3.6V / 1.5Ah | 3hrs | 2.5W | 105lm | 1080g |

• Dimensions: 363(L) x 145(W) x 73(H)mm

Additional Self-Adhesive Legends - To be ordered separately



S-93593/S65L



S-93593/S65R



S-93593/S65D

Eco Light - Emergency Luminares - 230V IP42

| Codes | Consumption | Battery Ni-Cd | Duration | Lamp | Light Output | Weight |
|----------------------------------------------------------------------------------------|-------------|---------------|----------|---------|--------------|--------|
| LED - Maintained Edge Illumination with Green LEDs & Transparent Background | | | | | | |
| MLD28/G | 7.5VA | 3.6/1Ah | 3hrs | 8 LEDs | 18/18lm | 500g |
| MLD34/G | 8VA | 3.6/1Ah | 3hrs | 11 LEDs | 18/22lm | 800g |
| MLD44/G | 8VA | 3.6/1Ah | 3hrs | 13 LEDs | 18/22lm | 1200g |

| Codes | Consumption | Battery Ni-Cd | Duration | Lamp | Light Output | Weight |
|----------------------------------------------------------------------------------|-------------|---------------|----------|---------|--------------|--------|
| LED - Maintained Edge Illumination with White LEDs & Green Background | | | | | | |
| MLD28/W | 7.5VA | 3.6/1Ah | 3hrs | 8 LEDs | 45/45lm | 520g |
| MLD34/W | 8VA | 3.6/1Ah | 3hrs | 11 LEDs | 45/55lm | 860g |
| MLD44/W | 8VA | 3.6/1Ah | 3hrs | 13 LEDs | 45/55lm | 1250g |

Dimensions

| | |
|-------|---------------------------|
| MLD28 | 280(L) x 100(H) x 75(W)mm |
| MLD34 | 340(L) x 170(H) x 75(W)mm |
| MLD44 | 440(L) x 220(H) x 75(W)mm |

Accessories included:



• Includes 2 pairs of special PVC Overlays

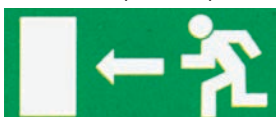

Accessories

| | |
|--------|----------------------------------------------------|
| A-1022 | Rigid arms for ceiling installation; 20cm distance |
| A-1025 | Rigid arms for ceiling installation; 40cm distance |
| A-1026 | Rigid arms for ceiling installation; 60cm distance |
| A-1027 | Chains for ceiling installation; 50cm |
| A-1018 | Recessed mounting base for MLD28 |
| A-1020 | Recessed mounting base for MLD34 |
| A-1021 | Recessed mounting base for MLD44 |

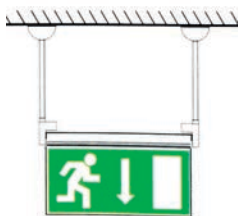

Hanging Installation using the special mounting sets.

- A-1022 - suitable for 20cm distance
- A-1025 - suitable for 40cm distance
- A-1026 - suitable for 60cm distance



Recessed Mounted Installation on suspended ceiling using the base type A-1018, A-1020, A-1021

HIGHBAY EMERGENCY BACKUP KIT

NEW



Highbay to be ordered separately

Input Voltage: 100-277VAC | Compatible with highbay: 0-200W | Highbay must have 0/1-10V Input | Highbay will reduce power to 30% when emergency is active | Protection: Over Voltage, Short Circuit, Overload & Open Circuit | Self-diagnostics: The unit will automatically conduct monthly 30 minute and manual 90 minute test

| Code | Output Voltage | Output Power | Highbay | Emergency Time | Dimensions |
|---------------|----------------|--------------|---------|----------------|------------|
| HB-EMG-40-90M | 170VDC | 40W | 0-150W | 90min | Ø142 x 239 |
| HB-EMG-60-90M | 170VDC | 60W | 200W | 90min | Ø142 x 239 |

Accessories

| Code | Description |
|---------------|----------------------------------------------------|
| HB-EMG-REMOTE | Wireless Remote Control for Emergency Test Control |

EMERGENCY ILLUMINATION



LED Non Maintained - Ceiling Mounted IP42 - Input Voltage: 230VAC | Deep Discharge and Overcharge Protection | 24hrs Charge Time | Each device must be permanently connected to mains power supply. In normal operation the battery is charging. In case of a mains power failure the device will light the illumination LED automatically in emergency mode. When power is restored the device turns to normal operation

| Codes | Wattage | Battery Ni-CD | Duration | Lamp | Lumens | Weight | Size (mm) |
|--------|---------|---------------|----------|------|--------|--------|----------------|
| GR-471 | 24W | 36V/1.2Ah | 1.5h | 2W | 160lm | 470g | 195 x 195 x 60 |



LED Recessed Emergency Downlight IP20 - Input Voltage 230VAC | Battery: 3.7V 3Ah 18650 | Charge Time 12h | Built-in Test Function | 160° Beam Angle | Non-Maintained | Applications: Hotels, Restaurants, Shopping Malls, Offices, & Public Places to provide Illumination for Evacuation

| Code | Wattage | Lumens | Duration | Size (mm) |
|--------------|---------|--------|----------|--------------|
| JH-396B-3W-* | 3W | 180lm | ≥3hrs | Ø60 x 26.5mm |

*Add colour temp. to code: ○ WW (3000K), ○ CW (4200K)



LED Downlight Emergency Kit - 230V

| Codes | Consumption | | Battery Ni-Cd | Duration | | Lumen |
|-------|-------------|--------|---------------|----------|--------|-------|
| | 1 Spot | 4 Spot | | 1 Spot | 4 Spot | |

Non-Maintained Converter with battery

| | | | | | | |
|-------|-----|------|------------|------|-------|------------|
| GR-76 | 4VA | 28VA | 3.6V / 1Ah | 3hrs | 45min | 100 / 50lm |
|-------|-----|------|------------|------|-------|------------|

LED Downlight

| | | | | |
|-----------|-------|---|---|------|
| GR-83 LED | 1.5VA | - | - | 40lm |
|-----------|-------|---|---|------|

Emergency

- Dimensions: 82 x 82 x 29mm
- To fit standard 3" x 3" box (75 x 75mm)



LED "Weatherproof Spotlight" - Emergency Luminaires IP65

| Codes | Voltage | Consumption | Light Source | Light Output |
|-----------------------------|---------|-------------|--------------|--------------|
| LED - Non-Maintained | | | | |
| GR-80 | 230VAC | 6VA | 9 LEDs | 30lm |

• Flush mounting in junction box or plaster board.

STEEL LED EMERGENCY EXIT SIGNS

Steel LED Emergency Exit Signs - Input Voltage: 230VAC | Self Contained | Surface Mount | Certificate No. 159443/001



LED-EXIT-1



LED-EXIT-2













LED-EXIT-3

| Codes | LED Wattage | Emergency Time | Battery Type | Size (mm) |
|------------|-------------|----------------|--------------|----------------|
| LED-EXIT-1 | 2W | 2hrs | Ni-Cad | 375 x 25 x 147 |
| LED-EXIT-2 | 2W | 2hrs | Ni-Cad | 375 x 25 x 147 |
| LED-EXIT-3 | 3W | 3hrs | Ni-Cad | 430 x 45 x 215 |

LIGHTING

EMERGENCY ILLUMINATION

| |  | Wall Mount  | Double Sided c/w 25cm chains  | Legends  - RIGHT  - LEFT  - DOWN  - EXIT |
|----------------------------|-----------------------------------------------------------------------------------|--------------------------------------------------------------------------------------------------------|---------------------------------------------------------------------------------------------------------------------------|---------------------------------------------------------------------------------------------------------------------------------------------------------------------------------------------------------------------------------------------------------------------------------------------------------------------------------------------------------------------------------------------------------------------|
| Code Non-Maintained | LED808NM | LED308SNM | - | |
| Code Maintained | LED808M | LED308SM | KE328 | |
| Lamp | 0.9W | 0.9W | 0.7W | |
| Mounting | Recessed ceiling mount | Wall Mount | Ceiling Mount | |
| Material | Sheet Steel & Polycarbonate | Sheet Steel & Polycarbonate | Aluminium & Acrylate Plastic | |
| Battery | 3.6V 900mAh > 3hrs | 3.6V 900mAh > 3hrs | Ni-Cd 3.6V 350mAh > 3hrs | |
| Size (mm) | 410 x 140 x 240 | 392 x 190 x 61 | 370 x 52 x 500 | |
| Legends | | | | |
| Exit | KEX808-EXIT | KE308S-EXIT | - | |
| Down | KEX808-DOWN | - | KE328-DOWN | |
| Left | - | KE308S-LEFT | KE328-L/R | |
| Right | - | KE308S-RIGHT | KE328-L/R | |

| |  |  | Bulk Head IP65  | IP65  |
|----------------------------|-------------------------------------------------------------------------------------|-------------------------------------------------------------------------------------|---------------------------------------------------------------------------------------------------------------|------------------------------------------------------------------------------------------------------|
| Code Non-Maintained | - | - | - | KE108/LED/NM |
| Code Maintained | KES112LED | KE338 | KEM2D28W | KE108/LED/M |
| Lamp | 0.7W | 0.9W | 16W | 3W |
| Mounting | Recessed Ceiling Mount | Ceiling Mount | Wall or Ceiling Mount | Wall or Ceiling Mount |
| Material | Aluminium & Acrylate Plastic | Aluminium & Acrylate Plastic | Polycarbonate Plastic | Polycarbonate Base & Diffuser |
| Battery | 3.6V 900mAh > 3hrs | 3.6V 900mAh > 3hrs | 3.6V 4.5Ah > 3 hrs | 3.6V 1.5Ah |
| Size (mm) | 65 x 340 x 470 | 400 x 52 x 530 | Ø320 x 115 | 352 x 102 x 72 |
| Legends | | | | |
| Exit | KES112LED-EXIT | KE338-EXIT | - | - |
| Down | - | KE338-DOWN | - | - |
| Left | KES112LED-L/R | KE338-L/R | - | - |
| Right | KES112LED-L/R | KE338-L/R | - | - |

Maintained: When mains power is on the light is on. When mains fails the light stays on Non-Maintained: When mains power is on the light is off. When mains fails the light comes on.



LED Emergency Twin Spot IP65 - Automatic operation | Built-in charger |

Back-up time: > 3hrs

| Code | Supply | Battery | Lamps | Size (mm) |
|--------------------|--------|----------|--------|----------------|
| KE448LED-NM | 230VAC | 3.6V 6Ah | 2 x 6W | 305 x 305 x 76 |

Ceiling Mount Exit Emergency Light IP20 - 230V Both side indicator

| Codes | Power | Battery Ni-Cd | Duration | Size (mm) | Auto Switch On Power Failure |
|----------------|--------|---------------|----------|----------------|------------------------------|
| DL-758S | 1 x 8W | 6V/1.2AH | 1.5hrs | 410 x 90 x 160 | Yes |

*1st Tube for permanent light, 2nd Tube for emergency light. Include battery c/w internal charger



RECHARGEABLE EMERGENCY LED LIGHTS

EMG-A60
5W, 9W

EMG-A60-12W

EMG-DIM-A60

EMG-GU10-3W
EMG-GU10-5W

LED A60 Emergency Lamp - Working Time: 4 - 5 Hours

| Code | Wattage | Lumens | EMG Lumens | Size (mm) | Base |
|----------------------|---------|--------|------------|-----------|----------------------|
| EMG-A60-5W-* | 5W | 375lm | 250lm | 60 x 108 | E27 with B22 Adaptor |
| EMG-A60-9W-* | 9W | 675lm | 300lm | 60 x 108 | E27 with B22 Adaptor |
| EMG-A60-12W-* | 12W | 900lm | 350lm | 80 x 170 | E27 with B22 Adaptor |

Dimmable A60 Emergency Lamp - 3 Step dimming on DC Mode | 300lm - 2hrs, 120lm - 4hrs, 50lm - 7hrs | c/w Shorting Cap and Hook | Overcharge & Discharge Protection

| Code | Wattage | Lumens | EMG Lumens | Size (mm) | Base |
|--------------------------|---------|--------|------------|-----------|----------------------|
| EMG-DIM-A60-7W-* | 7W | 650lm | 50lm | Ø60 x 120 | E27 with B22 Adaptor |
| EMG-DIM-A60-9W-* | 9W | 880lm | 120lm | Ø65 x 133 | E27 with B22 Adaptor |
| EMG-DIM-A60-11W-* | 11W | 1100lm | 300lm | Ø70 x 145 | E27 with B22 Adaptor |

*Add colour to code: ○ **CW** (Cool White), ○ **DL** (Daylight)

LED GU10 Emergency Lamp - Working Time: 2-3 Hours

| Code | Wattage | Lumens | EMG Lumens | Size (mm) | Base |
|----------------------|---------|--------|------------|-----------|------|
| EMG-GU10-3W-* | 3W | 190lm | 85lm | Ø50 x 55 | GU10 |
| EMG-GU10-5W-* | 5W | 350lm | 120lm | Ø50 x 80 | GU10 |

*Add colour to code: ○ **WW** (Warm White), ○ **CW** (Cool White), ○ **DL** (Daylight)

Dimmable GU10 Emergency Downlight - 3 Step dimming on DC Mode | 135lm - 2.5hrs, 60lm - 5hrs, 24lm - 7hrs | c/w Shorting Cap and Hook | Overcharge & Discharge Protection

| Code | Wattage | Lumens | Size (mm) | Base |
|--------------------------|---------|--------|-----------|------|
| EMG-DIM-GU10-6W-* | 5W | 450lm | Ø50 x 80 | GU10 |

*Add colour to code: ○ **CW** (Cool White), ○ **DL** (Daylight)



LED Floodlights with Emergency Backup Power IP65 - Input Voltage: 230VAC | 110° Beam Angle | Colour Temp. 6000K | 3 Hour Backup Time | Lithium Ion Battery

| Code | Wattage | Emg. Watts | Lumens | Size (mm) |
|-----------------------|---------|------------|---------|----------------|
| EMG-FL-20W-DL | 20W | 6W | 100lm/W | 170 x 168 x 36 |
| EMG-FL-50W-DL | 50W | 10W | 120lm/W | 214 x 188 x 41 |
| EMG-FL-100W-DL | 100W | 10W | 120lm/W | 253 x 231 x 52 |

Standard LED Emergency Lamps for Domestic Use - Supply Volts 230VAC

Complete with battery charger | Charging Time: 24 hours | Perfect for use as a portable work lamp

| Code | Lumen | Battery | Discharge Time | Size (mm) |
|----------------------|---------------------------|----------------------|-------------------------------------------------|----------------|
| RWELEDJ-2 | Low - 40lm High - 80lm | 3.7V 1200mAh | Low - 6hrs High - 3hrs | 270 x 65 x 52 |
| NS350LX | 300-350lm | 3.7V 1200mAh | 4hrs | 220 x 65 x 40 |
| NS650LX | 270lm | 4VDC | 4hrs | 395 x 60 x 44 |
| LED008 | 98+220lm | 3.7V 2200 mAh | 8hrs single LED 4hrs multiple LEDs | 220 x 77 x 120 |
| AL-2166 | 360lm | 3.7V 1.8Ah Li-ion | Max Power up to 1.5hrs Low Power up to 10hrs | 325 x 55 x 30 |
| AL-3600 | 360lm | 3.7V 1.8Ah Li-ion | Low - 4hrs High - 2hrs | 392 x 58 x 43 |
| AL-2060 | 400/200lm | 3.7V 3.0Ah Li-ion | Low - 8hrs High - 4hrs | 360 x 75 x 50 |
| JCL-T5-901-4W | 400lm | 3.7V 1.8Ah Li-ion | 6hrs | 300 x 40 x 23 |
| JCL-T5-901-6W | 600lm | 3.7V 1.8Ah Li-ion | 6hrs | 600 x 40 x 23 |

Rechargeable LED Lamps - Lamp can be operated from the mains or from the built in battery | Charge time: 4hrs | Battery life: 4hrs when fully charged | Automatic emergency illumination function | Supplied with a lampholder adaptor so that the lamp can be used in Bayonet or screw-in fittings

| Code | Description |
|----------------|------------------------------------------------------------------|
| AS-8221 | LED emergency lamp c/w E27 lamp holder adaptor and ON/OFF remote |
| AS-8222 | LED emergency lamp c/w E27 lamp holder adaptor |

AS-8221

AS-8222

CHICKEN FARM LIGHTING SYSTEM



AMB-IDS

Programmable Dimmer & Timer IP66 - Input Voltage: 230VAC | Support DIY Programming | Master / Slave Function, supports both Triac & 0-10V Dimming. "Master Function" - Control dimming from the unit, "Slave Function" - Use central 0-10V control system dimming. | Leading Edge & Trailing Edge | 0%-100% Dimmable, dimming precision 1% | 7 inch LCD | Easy replacement for traditional lamps, no need to rewire the existing cable installation.

| Code | Output Current | Max Watts |
|---------------|----------------|-----------|
| AMB-IDS-2000W | 1 x 10A | 2000W |
| AMB-IDS-4000W | 2 x 10A | 4000W |



WP4A

A Series - T8 Triac Dimmable IP66 - Input Voltage: 230VAC | Double V-Shape 150° Viewing Angle | CRI > 80 | L80B50 70 000hrs | **Full spectrum** | Dimming from 0.2% - 100% without flicker to simulate sunrise to sunset | 300mm male and female connector for series connection | Anti-ammonic and acid for poultry industrial lighting | To be used with **AMB-IDS** controller

| Code Triac | Wattage | Lumens | Length (mm) |
|-----------------|---------|--------|-------------|
| WP4A-T8-20W-D-* | 20W | 2000lm | 1200 x 28 |

* Add Colour Temperature to Code: ○ **WW** (3000K), ○ **CW** (4200K), ○ **DL** (5000K)



AMB-PE

AMB-TC

AMB-ME

A Series - T8 0-10V Dimmable IP66 - Input Voltage: 230VAC | V-Shape 150° Viewing Angle | CRI > 80 | L80B50 70 000hrs | **Full spectrum** | Dimming from 3% - 100% without flicker to simulate sunrise to sunset | 300mm male and female connector | Anti-ammonic and acid for poultry industrial lighting | Compatible with any 0-10V Control System

| Code 0-10V | Wattage | Lumens | Length (mm) |
|------------------|---------|--------|-------------|
| WP4E-T8-20WH-D-* | 20W | 2000lm | 1200 x 28 |

* Add Colour Temperature to Code: ○ **WW** (3000K), ○ **CW** (4200K), ○ **DL** (5000K)

Accessories

| Code Triac | Description | Code 0-10V | Description |
|------------|-------------------------------|------------|-------------------------------|
| AMB-PE | 1m Power Extension | WP4E-PE | 1m Power Extension |
| AMB-ME | 4m Middle Extension | WP4E-ME | 4m Middle Extension |
| AMB-TC | "T" Connector | WP4E-TC | "T" Connector |
| AMB-M15 | 15m Extension from Controller | WP4E-M15 | 15m Extension from Controller |
| AMB-EC | End Cap | AMB-EC | End Cap |

Mounting Accessories

| Code | Description |
|--------|----------------------------------------------|
| AMB-SK | Suspended Mounting Kit (Complete for 1 Tube) |
| AMB-CM | Ceiling Mounting Kit (Complete for 1 Tube) |
| AMB-RM | Ring Mounting kit (Complete for 1 Tube) |

Poultry Farm LED Lamp IP65 - | Input Voltage: 230VAC | 4200K | Dimmable 0 - 100% | Beam Angle: 220° | Working Temperature: -20° to 50° | Alumite treated to protect against corrosion.

| Code | Wattage | Lumens | Size (mm) |
|----------|---------|--------|-----------|
| BE27-7W | 7W | 700lm | Ø43 x 158 |
| BE27-12W | 12W | 1200lm | Ø49 x 179 |

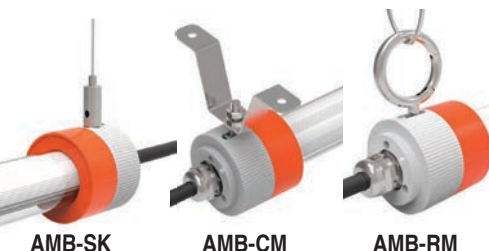

AMB-SK

AMB-CM

AMB-RM



BE27

LED LOW BAY PLANT GROW SYSTEM



LED Plant Grow Bay IP65 - Input Voltage 85-305V | Dimmable 0-10V | 120° Beam Angle | Full spectrum 3000K+6500K+660nm+IR730nm | Uniform Light Coverage | Applications: Greenhouse, Hydroponics, Multiculture, Aeroponics, Garden or grow tent

| Code | FU-BLX-320 | FU-BLX-640 |
|-----------|-------------------|-------------------|
| Wattage | 320W | 640W |
| Lumens | 6867lm | 12578lm |
| Ratio | White+660nm+730nm | White+660nm+730nm |
| PPF | 2.8 - 3.2 umol/J | 2.8 - 3.2 umol/J |
| LED Qty | 960pcs | 960pcs |
| Size (mm) | 1200 x 600 x 80mm | 1200 x 600 x 80mm |

LED LOW BAY PLANT GROW SYSTEM



| Code | H158D-140W | H161D-280W | H162-350W | Spares | |
|---------------|-----------------|-----------------|-----------------|-------------------|------------------------------------------------------|
| Input Voltage | 100-240VAC | 100-240VAC | 100-240VAC | Code | Description |
| Output Power | 140W | 280W | 350W | H4-MOD-35W | Spare light module 35W |
| Lumens | 5180lm | 10563lm | 13204lm | H4-DRV-70W | Spare LED Driver (one driver drives 2 light modules) |
| Size (mm) | 280 x 280 x 70H | 540 x 280 x 70H | 670 x 280 x 70H | | |

Features • Easy maintenance: Modular system • Air circulation system design - to obtain the ideal Co₂/O₂ ratio considerably improving plant growth
• Self testing function - when indicator light is on, the light module is faulty and needs to be changed.

LED PLANT GROW LIGHTS



T8 Plant Growing SMD LED Tubes - Input Voltage: 85-265VAC | Plant grow lamps have LED's that produce light in Blue (450nm) and Red (660nm) wavelengths that are ideal for promoting photo-biological processes in plants. These lamps can be used wherever plants do not receive enough natural light or in agricultural applications.

| Code | Length | Power | Replaces T8 Lamp |
|---------------------|--------|-------|------------------|
| LEDT8PG-A2FR | 600mm | 9W | 18W (2FT) |
| LEDT8PG-A3FR | 900mm | 15W | 30W (3FT) |
| LEDT8PG-A4FR | 1200mm | 18W | 36W (4FT) |
| LEDT8PG-A5FR | 1500mm | 22W | 58W (5FT) |



LED PAR38 Plant Grow Lamp - IP65

| Code | Base | Watts | Lumen |
|-------------------------|------|-------|-------|
| LED-PAR38-12W-PG | E27 | 12W | 171lm |

- 75% Red, 25% Blue
- The wave length for red is 662nm, for blue is 447nm



A60 LED Filament Plant Grow Lamp E27 - Input Voltage: 220 - 240VAC | Dimensions: Ø60 x 108mm | Full Colour Spectrum for general use | Ideal for greenhouse glass or plastic, Planting factory, Hydroponic shelves, Home Planting.

| Code | Wattage | Colour Spectrum | PPF (400-700nm) | PAR Watt (W) (400-700nm) | PPF (400-700nm) |
|----------------------|---------|-----------------|-----------------|--------------------------|-----------------|
| XGY-A60-8-E27 | 8W | Full Spectrum | >12 µ mol | 0.3 - 0.5mW | >1.5 µ mol/s/W |

Specialized



LED Plant Grow Strips IP65 - Supplied with 230VAC Power Adaptor | LED Strip 24VDC Lumens: 10-22lm | Viewing Angle: 120° | Blue (Wave Length: 455-465nm) - Good for Photosynthesis. | Red (Wave Length: 660-665nm) - Peak Wavelength for Photosynthesis & Photoperiodism - Good for Blooming & Fruits | Red/Blue in one Chip: Red:Blue = 5:1 (Suitable for most Plant Growing)

| Code | Description | No. LEDs | Max Power/m | Length |
|-------------------|--------------|----------|-------------|--------|
| HH-SRB60W | Red/Blue 5:1 | 60lm | 14W/m | 10m |
| HH-SRB120W | Red/Blue 5:1 | 120lm | 28W/m | 10m |
| HH-SR-60W | Red | 60lm | 14W/m | 10m |
| HH-SB-60W | Blue | 60lm | 14W/m | 10m |



LED Plant Grow Floodlight IP65 - Input Voltage: 230VAC | Beam Angle 120° | Red¹⁶ & Blue⁴ | Wavelength: Red 630-660nm, Blue 400-470nm

| Code | Wattage | Lumens | Size (mm) |
|-----------------------|---------|--------|----------------|
| PG-GY225TG-20W | 20W | 1300lm | 200 x 180 x 45 |

LIGHTING



Clamp Grow Lights IP44 - Input Voltage: 85-265VAC | Lamp Life 50 000hrs | 360° Adjustable Head | Easy Mounting System

| Code | No. of Heads | Wattage | Red : Blue : White | Goose Neck Size (mm) |
|---------------|--------------|---------|--------------------|----------------------|
| CGL-15 | 1 | 1 x 12W | 5 : 4 : 3 | Ø95 x 495 |
| CGL-30 | 2 | 2 x 12W | 5 : 4 : 3 | Ø95 x 495 |

PPFD per Head: 579 µmol @ 200mm / 434 µmol @ 300mm
Coverage per Head: 400 x 400 @ 300mm / 500 x 500 @ 400mm

LED UVC LIGHTS

UVC Ultraviolet LED Cabinet Light IP20 - Input Voltage: 5VDC USB Rechargeable
Wavelength 270-280nm | UV Sterilization & General Lighting | 140° Beam Angle | Built in motion sensor, when movement is detected Sterilization mode turns to daylight 6000k mode.

| Code | Wattage | Spectrum | Size (mm) |
|----------------|---------|-------------|---------------|
| DL-UVC-BAR-150 | 0.6W | White + UVC | 150 x 36 x 17 |
| DL-UVC-BAR-300 | 2W | White + UVC | 300 x 36 x 17 |

UVC LED Germicidal Light IP20 - Input Voltage: 230VAC | Wavelength 275+360nm
| UV Sterilization | 140° Beam Angle | Aluminium + PC | Applications: Kitchen, Wardrobe, Closets & Cupboards | 30min for daily disinfection, 60min. Kills most bacteria and other micro-organisms.

| Code | Wattage | Spectrum | Size (mm) |
|-------------|---------|----------|----------------|
| KS-UVC-A4W | 4W | UVC | 300 x 28 x 14 |
| KS-UVC-A8W | 8W | UVC | 600 x 28 x 14 |
| KS-UVC-A16W | 16W | UVC | 1200 x 28 x 14 |

Hand-held UVC Light IP20 Input Voltage: 12VDC Rechargeable | Wavelength 240-280nm | Aluminium | Portable Handheld Device | Ideal for Travel

| Code | Wattage | Spectrum | Size (mm) |
|--------------|---------|----------|---------------|
| UL-UVC-PT-01 | 1.8W | UVC | 350 x 40 x 35 |

Antibacterial LED Panel IP65 - Input Voltage: 230VAC | 120° Beam Angle | Aluminium + PMMA | Low Glare <19 | Dust and Waterproof | Applications: Hospital, Clean Room, Pharmaceutical Factory, Operating Room, Food Facilities. | A particular photocatalytic coating on the LED panel light ensures that bacteria and viruses that come in contact with the surface of the panel for a short period of time can be rendered harmless.

| Code | Wattage | Lumens | Size (mm) |
|----------------|---------|--------|-----------|
| ABPC-6060-36-* | 36W | 3600lm | 595 x 595 |

*Add colour to code: ○ CW (Cool White 4200K), ○ DL (Daylight 6000K)

Germicidal Surface Mount LED Panel IP44 - Input Voltage: 230VAC | 120° Beam Angle | Antistatic treated to avoid dust build up | Two function wall switch control sterilization and illumination, mode 1. Cool white (4000K) with no harmful UVC or blue light in spectrum, mode 2. UVC germicidal action, UVC: 270-280nm | Ideal for hospital, pharmaceutical, clean room, laboratories and food produce factories.

| Code | Wattage | Lumens | Spectrum | Size (mm) |
|-----------------|---------|--------|----------|-----------------|
| DFL-UVC-6060-40 | 40W+20W | 4000lm | UVC | 620 x 620 x 12 |
| DFL-UVC-1203-40 | 40W+20W | 4000lm | UVC | 1220 x 320 x 12 |

360° UV Disinfection Lamp - Input Voltage: 230 | Irridation Area 50m² | UV Startup Delay 10s | Quartz Ultraviolet Lamp | Rated 10000hrs | U-Tube 340mm | All metal Lamp Holder | c/w Remote | Wavelength UV 253.7nm, Ozone 185nm

| Code | Wattage | Spectrum | Size (mm) |
|------------|---------|-----------|-----------------|
| PTX-003-WH | 38W | UVC+Ozone | 210 x 210 x 470 |

Accessories

| Code | Description |
|--------------|-------------------------|
| PTX-003-LAMP | Spare Lamp UN-C 253.7nm |

T8 UVC LED Tube - Input Voltage: 85-265VAC | 120° Beam Angle | Wavelength Range 270-280nm | Peak Wavelength 275nm | Radiant Flux max 5mW | Ceramic Substrate and Quartz Glass | Highly effective against inactivating and destroying the DNA of micro organisms found in mould, germs, bacteria and viruses.

| Code | Wattage | Spectrum | Size (mm) |
|--------------|---------|----------|------------|
| LEDT8-UVC-A2 | 9W | UVC | 600 (2ft) |
| LEDT8-UVC-A4 | 15W | UVC | 1200 (4ft) |
| LEDT8-UVC-A5 | 20W | UVC | 1500 (5ft) |



PARKING BAY LIGHTING IP65

Ultra Sonic Parking Bay Linear Light - Input Voltage: 85-265VAC | Aluminium + PC |
The luminaire uses an ultra sonic sensor to detect the presence of a vehicle | Installation height: 2-10m



| Code | Application | Lumens | Power | Dimensions (mm) |
|-----------|-------------|--------|---------------------|-----------------|
| PB-600-1 | 1 Bay | 20W | 2000lm @ Full Power | 600 x 48 x 48 |
| PB-2000-2 | 2 Bays | 40W | 4000lm @ Full Power | 2000 x 48 x 48 |

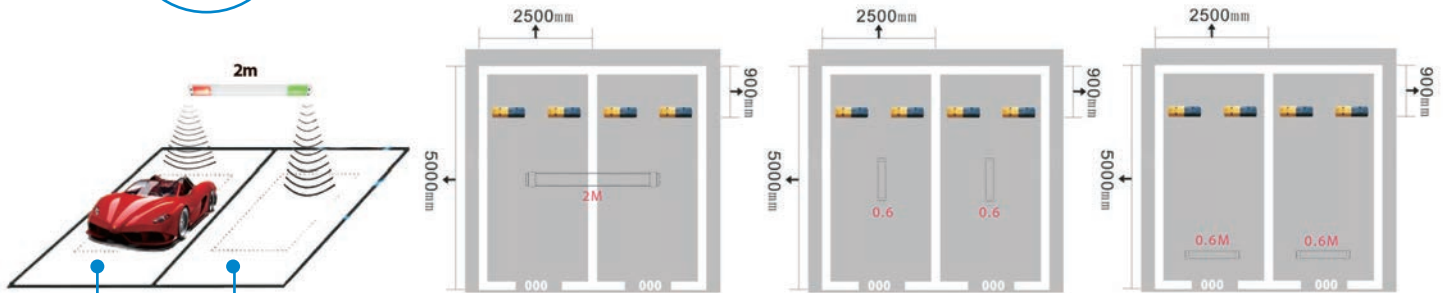

Vehicle not present, the luminaire will be partly green and dim down to 30%

Vehicle present, the luminaire will turn partly red and will brighten up to full power for 180sec then dim down to 30% light output

WORK LIGHTS

IP67
with magnet



LED

Magnet & 360° Flexible Hook



LED

NEW

360° Rotation Hook Magnetic Base



| Code | SP-W814 | SP-WL47B | SP-WL14ARC |
|--------------|------------------------------------------------|---------------|-------------------------|
| Lamp | 1 LED Top + 3W COB Inside | 3W | 1W + 3W COB |
| Lumen | 300lm | 300lm | 70lm - 120lm |
| Power Supply | 3.7V 1800mAh Rechargeable 18650 Li-ion Battery | 3 x AA (Incl) | 3.7V 1800mAh Li-ion USB |
| Battery Life | 3hrs | - | - |



165mmØ

125mmØ



NEW LED



| Code | HL-13 | AWL-009 | JLM8933 | SP-001 | AWL-006 | LK608007 | AWL-006-DC | SP-JK1115 | |
|-------------|------------------------------------|---------|-----------------------------------|----------------------------------------------------|------------------------|-------------------------------------------------|---------------------------|------------------------|----------------|
| Power | 1 million/0.5 million Candle Power | 12V 55W | 2 million Candle Power | 12V 100W | 20W LED (2000lm) | 60W max (E27) | 60W max (E27) | 60W max (E27) | 100W max (E27) |
| Lamp | 12V 55W | | 12V 100W | - | - | - | - | - | - |
| Spare Lamp | H3-55-12VDC | | H3-100W-12VDC | - | - | - | - | - | - |
| Description | 6" Spotlight c/w car lighter plug | | 6" Spotlight c/w car lighter plug | Material: PC + ABS, 5m Lead Top Hook & Handle Hook | Auto Lamp c/w 3m cable | Metal frame with rubber protection c/w 3m cable | Connects into car lighter | Auto Lamp c/w 3m Cable | |

WORK LIGHTS

| | 3-in-1 Torch / Lantern / Powerbank | 2-in-1 Torch / Lantern | LED Working Floodlight | |
|---------------------|-------------------------------------------------------------------------------------------------------------------------------------------------------|----------------------------------------------------------------------------------------------------------------------------|------------------------------------------------------------------------------------------------------------------------------------------------------------------------------|---------------------------------------------------------------------------------------------------------------------------------|
| | c/w Charging Adaptor 1 x USB 5VDC/500mA 2 x 4VDC for Lamps  | c/w Built in Charger  | NEW 3 Working Mods: 100% - 60% - 20% - EMG Full Charge - 10hrs Work Time  |  |
| Code | YJ-2886 | YJ-2829 | TG01-30W | TG01-50W |
| Wattage | 1 x 5W + 22 SMD | 1 x 5W + 25 SMD | 30W | 50W |
| Lumens | 550lm | 550lm | 6000lm | 10000lm |
| Batteries | 2 x 2200mAh | 6000mAh | 3.7V / 5Ah | 3.7V / 10Ah |
| Rechargeable | Yes | Yes | USB / Car Charger / Adaptor | |
| Size (mm) | Ø100 x 140 x 190 | Ø120 x 220 | 218 x 280 x 57 | 245 x 324 x 60 |
| | Floodlight / Spotlight / Mode Emergency Flash IP44  | Rotatable 90° Swivel Tripod Stand  | Detachable Side Light-Flashing Amber Retractable Tripod Stand  | Swivel Stand Two Brightness Settings  |
| Code | KB8201 | KB8933CP | KB2601A | KB2146-20W |
| Wattage | 10W | 10W | 10W + 3W | 20W |
| Lumens | 700lm | 650lm | 850lm | 1600lm |
| Batteries | 3.7V 2400mAh | Direct | 7.4V 2400mAh | 7.4V 2400mAh |
| Rechargeable | ACDC or 12VDC Car Adaptor / USB | No 12VDC Car Plug | ACDC Adaptor / 12VDC Car Charger / USB | ACDC Adaptor / 12VDC Car Charger / USB |
| Size (mm) | 220 x 147 x 166 | 280 x 290 x 320 | 208 x 122 x 240 | 226 x 165 x 179 |
| | NEW 6000K 180° Adjustable LED Head  | NEW 6000K  | NEW 6000K  | |
| Code | SP-016 | SP-019 | SP-010A | |
| Wattage | 2 x 10W | 2 x 10W | 2 x 10W | |
| Lumens | 2 x 700lm | 2 x 1000lm | 2 x 1000lm | |
| Batteries | 4000mAh | 3.7V 2 x 2000mAh | 3.7V 2 x 2200mAh | |
| Rechargeable | USB | Yes | Yes | |
| | Charge Time 4 hrs 3-6hours Run Time | Charge Time: 5hrs Working Time: 2hrs 100% | Charge Time: 4-5hrs Working Time: 2-4hrs | |
| Size (mm) | 205 x 245 x 50 | Ø41 x 416 | Ø65 x 650 | |
| Features | Magnetic Base Battery Indicator Dimmable 100-50% | Back to Back Work Light Can join two single sides Modes: 100% on / 50% on c/w Hook & Magnetic Vase | Double sided Work Light 360° c/w Tripod Hook Magnetic Bottom Modes: one side - two sides - off | |

Portable

LIGHTING

TORCHES

| | HardCase Pivot | Impact Light | Basic Plastic Led | Water proof light | Tactical |
|--------------------|---------------------------------------------------------------------------------------------------------------------------|-------------------------------------------------------------------------------------------------------------------------------------------------|-------------------------------------------------------------------------------------------------------------------|------------------------------------------------------------------------------------------------------------------------|------------------------------------------------------------------------------------------------------------------------------------------------|
| | | | | | |
| Code | EL-HC-PIVOT | EL-IMPACT-2AA | EL-PLASTIC-2D | EL-WPROOF-2AA | EL-TAC700-RC |
| Lumens | 300lm(high)/30lm Low | 60lm | 25lm | 55lm | 700lm |
| Batteries | 2xAA included | 2xAA included | 2xD not included | 2xAA included | Rechargeable |
| Working Time | 5h(high)/30h(Low) | 30h | 120h | 35h | Up to 2h |
| Effective distance | Up to 30M | 65m | 35m | 50m | Up to 100m |
| IP rating | IPX4 | - | - | IPX7 | IPX4 |
| Features | <ul style="list-style-type: none"> Pivoting Head Magnetic foot Drop tested: 7m | <ul style="list-style-type: none"> Durable Rubber construction Built in stand for hands free use Non-slip grip | <ul style="list-style-type: none"> Easy to operate Long runtime Lanyard included | <ul style="list-style-type: none"> Floats With reflective panels Durable construction | <ul style="list-style-type: none"> Durable aircraft grade aluminium Strike bezel head Multiple lighting modes |
| | | | | Can be used as a torch or a headlamp | |
| Code | SP-F08 | SP-FL32 | SP-FL3WC | SP-402-7C | SP-018 |
| Wattage | 8W | 1W | 3W | 0,5W | 0.5W |
| Lumens | 800lm | 100lm | 150lm | 1200 - 1400 MCD | 60lm |
| Batteries | 3 x C (not incl) | 3 x AAA (not Incl) | 3 x AAA (Not Incl.) | 3 x AAA (Not Incl) | - |
| Rechargeable | No | No | No | No | Yes (Shake to Recharge) |
| Size (mm) | Ø43 x 255 | Ø25 x 91 | Ø45 x 123 | 87 x 77 x 66 | Ø27 x 170 |
| Portable | Comes in case with charger & car adaptor Spare Battery: SP-T1000-BAT | | | Foldable Headlamp 90° Magnet Handle | Signal lamp; Red, Green & White |
| | Code | SP-T1000 | SP-BLH015 | 5JG-9915 | 5JG-A370 |
| | Wattage | 1W | 3W | 3W (CREE) | 3W (CREE) |
| | Lumens | 100lm | 120lm | 330lm | 330lm |
| | Batteries | 3.7V Li-ion (Incl) | 450mAh | 3 x AAA (Incl) | 2 x 18650 Lithium Battery (Incl) |
| Rechargeable | Yes | USB | Yes | Yes | |
| Size (mm) | Ø32 x 155 | Ø26 x 92 | Ø55 x 195 | Ø70 x 190 | |
| LIGHTING | 5-in-1 Mini LED Pocket Lamp 1 x USB 5VDC Charging Cable Colour Temp: 6000K c/w Magnet and Swivel Hook | Pen Light Magnetic Base & Hook | Aluminium Torch | 360° Rotatable Head Magnetic base Detachable head | 360° Rotatable Head Magnetic base Detachable head c/w Motion Sensor |
| | Code | SPWL-44AR | SP-WL32C | SP-SNL14D | HL-TC6145-1 |
| | Wattage | 20SMD + 3PCS | 3W | 3W | 3W |
| | Lumens | 400lm | 200lm | 120lm | 100lm |
| | Batteries | 3.7V 1200mAh Lithium Battery | 3 x AAA (Not Incl.) | 4 x AAA (Not Incl.) | 3 x AAA (Not Incl.) |
| | Rechargeable | Yes | No | No | No |
| Size (mm) | 97 x 68 x 25 | 40 x 18 x 160 | 20 x 75 x 14 | Ø76 x 75 | |





Portable

LIGHTING

HEAD LAMPS

| | | | | | |
|--------------------|---------------------------------------------------------------------------------------------------------|------------------------------------------------------------------------------------------------------------------------------|------------------------------------------------------------------------------------|-----------------------------------------------------------------------------------------------------------------|--------------------------------------------------------------------------------------|
| |  | Rechargeable c/w Adaptor & Batteries  |  |  |  |
| Code | SJ-2469 | SP22-B058B | SP-WL606 | SP2022 | EL-V-HL-200LM |
| Lumens | 1300 MCD | 12000-14000MCD | 120lm | 300lm | 200lm(high)/45lm(low) |
| Batteries | 3 x AAA (Not Incl) | 3 x AAA (Not Incl) | 3.7V 1200mAh | 800mAh | 3 x AAA (Not Incl) |
| Work Time | - | - | - | 3hrs Charge / 2hrs Discharge | 7h(High)/20h(Low) |
| Effective Distance | - | - | - | - | Up to 50m |
| IP Rating | - | - | - | - | IPX4 |
| Features | <ul style="list-style-type: none"> • 2,4,8 LED On • LED flashing • OFF | <ul style="list-style-type: none"> • Mode 1: 1 LED ON • Mode 2: 7 LED ON • Mode 3: Flashing | <ul style="list-style-type: none"> • On/Off Wave Sensing | <ul style="list-style-type: none"> • Steady on • Flashing • On/Off Wave Sensor | <ul style="list-style-type: none"> • Pivoting head • 2 modes |

WATERPROOF BICYCLE HEAD LIGHTS

| | | | |
|-----------------------------------------------------------------------------------|------------------------------------------------------------------------------------|-------------------------------------------------------------------------------------|--------------------------------------------------------------------------------------|
|  |  |  |  |
| Code | DY-H001 | DY-H010 | DY-H013 |
| Wattage | 3W | 6W | 9W |
| Lumens | 250lm | 500lm | 700lm |
| Light Modes | High / Low / Flash | Low / Medium / High / Flash | Low / Medium / High / Flash |
| Batteries | 4.2V 2000mAh | 8.4V 440mAh | 8.4V 440mAh |
| Rechargeable | Yes | Yes | Yes |

Kit Includes: Charger, Battery Pack, Battery Case, Headband, Mounting Ring

BICYCLE LIGHTS

| | | | | | |
|-------------------------------------------------------------------------------------|---------------------------------------------------------------------------------------------------------|-------------------------------------------------------------------------------------|---------------------------------------------------------------------------------------------------------|------------------------------------------------------------------------------------------------------------------------------------------------------------------------------|----------------------------|
|  | c/w Charging Kit  |  | With rear light  | Brake Light Gravity sensor to activate brake light. c/w 5VDC USB Cable  | |
| Code | SJ-2657 | JF404-1W | SJ-2750 | SJ-2659 | HL-BK4090 |
| Wattage | 1.5W | 1W | 1.5W | 0.3W | 0.4W |
| Lumens | 8400MCD | 4000MCD | 6000MCD | Head light: 2lm, Tail light: 3lm | 4lm |
| Batteries | 4xAA (not incl.) | 3 x AA (36V 600mA) Incl | 3 x AAA (not incl.) | Head 4 x AAA (not incl.) Rear 2 x AAA (not incl.) | 3.7 280mAh Lithium Battery |
| Rechargeable | No | Yes | No | No | Yes |
| Size (mm) | 52 x 80 x 112 | 85 x 72 x 100 | 32 x 54 x 80 | 95 x 30 x 50 | 43 x 27 x 40 |

CAMPING LIGHTS

| | | | | | |
|--------------|---------------------------|-----------------------|------------------------|--------------------------------------|------------------------|
| | | | | | |
| Code | YDC-5W-DL | CJ-2703 | SJ-3040* | CS2008GR | EL-V-LANTERN-RC |
| Wattage | 5W | 2W | 1W | 3W | - |
| Lumens | 500lm | 120lm | 90lm | 300lm | 1000lm High |
| Batteries | 3,7V 4400mAh Li-ion | 2 x AA (Not Included) | 3 x AAA (Not Included) | 400mAh | - |
| Rechargeable | Yes 4-5hrs working time | No | No | Yes Run time on full charge 8-10hr | Yes |
| Size (mm) | Ø80 x 117 | Ø135 | Ø135 | Ø105 x 160 | 305 x 200 x 75 |

*Add colour to code: ● S(Silver), ○ WH (White)

DECORATIVE LED LAMPS

Shade Material:
White glass
Base Material:
Painted
Aluminium
c/w Remote
Control

| | | | | | |
|-------------------|---------------------------|-------------------------------|------------------------|----------------------|-----------------------------------------------------------|
| | | | | | |
| Code | TAM-RGB/WW | YAM-RGB/WW | GLAM-RGB/WW | LUCIA-RGB/WW | LUNA-RGB/WW |
| Wattage | 5.5W | 5.5W | 5.5W | 6.5W | 5.5W |
| Lamp Colour | RGB & Warm White | RGB & Warm White | RGB & Warm White | RGB & Warm White | RGB & Warm White |
| Size (mm) | Ø137 x 258 | Ø137 x 258 | Ø200 x 198 | Ø200 x 200 | Ø250 x 200 |
| Spare Remote | RGB/WW-REMOTE | RGB/WW-REMOTE | RGB/WW-REMOTE | RGB/WW-REMOTE | RGB/WW-REMOTE |
| Material: Plastic | | Various Colours Available | Micro SD Card Slot | Blow On & Off | Hands Free, Wireless Music RF 10m Micro SD Touch Lamp |
| Code | OVORG-02 | IM880-* | IM887 | IM891 | LV-2015 |
| Wattage | 0.7W | 0.55W | 3W | 0.5W | 5W Speaker / 3.5W Light |
| Lamp Colour | RGB | White | RGB | Warm White | White |
| Feature | Colour Changing & Dimming | Glowing Mushroom Cap | Built in MP3 Player | Dimmable | Bluetooth |
| Size (mm) | Ø110 x 180 | 75 x 75 x 190 | Ø109 x 241 | 80 x 80 x 120 | Ø120 x 130 |

* Add mushroom cap colour to code: ● BL (Blue), ● GN (Green), ● O (Orange), ● Y (Yellow), ● P (Purple)

LED VENUE DECORATION LIGHTING

Rechargeable Light Modules - Working Time: 8 - 12 hrs. Charge Time: ±4hrs

| | | | | |
|---------------|-----------------------------------------------------------------|-----------------|--------------------|--------------------|
| | | | | |
| Code | SL-L117 | SL-L117D | SL-L120DS | SL-L120D |
| Power Output | 2W | 2W | 1W | 2W |
| Size (mm) | Ø117 | Ø117 | Ø120 | Ø120 |
| Charging Type | Induction Charging | Direct Charging | Induction Charging | Induction Charging |
| Kit Includes | LED light, remote control, battery, adaptor, waterproofing ring | | | |

LED DECORATIONS



Charger



Colour Changing

LED Colour Changing Light Ball (Indoor) - Rechargeable Batteries & 230VAC Battery Charger included | Colours include: Red, Green, Yellow, Blue, White, Cyan, Purple and Twinkle | Colour selectable or colour changeable by pressing switch | Batteries Included

| Code | Volts | Core | Material | Size (mm) |
|--------|-------|-------|------------|-----------|
| LB-001 | 4.5V | Empty | Silica Gel | Ø81 |

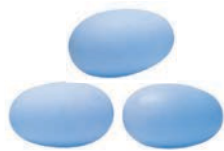

Garden LED Egg Shaped Decorative Light Kit IP68 - 3 x Eggs with 1m cable from egg to egg | Colour: ● R, ● GN, ● BL | Single Colour or Colour Changing | Complete with Power Supply and 7m cable

| Code | Volts | Core | Material | Size (mm) |
|----------|-------|------------------------------------|-----------|---------------|
| SL333115 | 2.7W | Light 24VDC with controller 230VAC | Polyresin | 165 x 95 x 85 |

BELT LIGHTS



LED Filament lamps included

Input Voltage: 240VAC | IP54 | Illumination Cable c/w Lamp Holders at Set Spacing | Indoor & Outdoor Applications | c/w 2700K 2W LED filament lamps

| Code E27 | Length | Lamp Spacing | No of Lamps | Control Wires |
|--------------------|--------|--------------|-------------|---------------|
| DC-S14-10M-E27 | 10m | 1m | 10 | 2 |
| DC-S14-10M-E27/0.5 | 10m | 0.5m | 20 | 2 |
| DC-S14-15M-E27 | 15m | 1m | 15 | 2 |
| DC-S14-15M-E27/0.5 | 15m | 0.5m | 30 | 2 |

Accessories

| Code | Description |
|--------------|------------------------------------|
| DC-E27-2W-CW | Plastic 2W Lamp / Cool White 4200K |
| DC-E27-2W-WW | Plastic 2W Lamp / Warm White 2700K |



B22



E27

Input Voltage: 100-240VAC | Illumination Cable c/w Lamp Holders at Set Spacing | Indoor & Outdoor Applications | 2 Wire for Static

| IP65 Code B22 | IP54 Code B22 | Length | Lamp Spacing | No of Lamps | Control Wires |
|---------------|-----------------|--------|--------------|-------------|---------------|
| BL-10-B22 | - | 10m | 450mm | 20 | 2 |
| BL-15-B22 | BL-ACDC-15-B22 | 15m | 375mm | 40 | 2 |
| - | BL-ACDC-50-B22 | 50m | 700mm | 70 | 2 |
| BL-100-B22 | BL-ACDC-100-B22 | 100m | 700mm | 143 | 2 |



Remote

Controller

NEW

Input Voltage: 230VAC | IP65 | Fixed RGBW Lamp | Lamp Type: G45 | c/w Controller | Ideal for Indoor and Outdoor Applications

| Code E27 | Length | Lamp Spacing | No of Lamps | Control Wires |
|--------------|--------|--------------|-------------|---------------|
| BLS-10M-RGBW | 10m | 800mm | 12 | 5 |

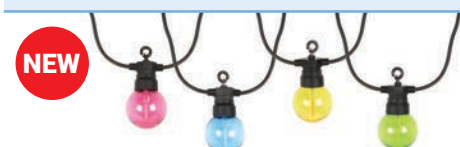

NEW

BL-LV-5M-M

Coloured LED Belt Light IP44 - Input Voltage: 230VAC | Low Voltage Outdoor Party & Festive Lights | c/w Transformer | Power Cable Length: 5m | Connectable | Filament LED | Plastic Bulb with Mounting Hooks

| Code | Length | Lamp Spacing | No. of Lamps |
|-----------------------------------|--------|--------------|--------------|
| LED Golf Ball Multi-Colour | | | |
| BL-LV-5M-M | 5m | 500mm | 10 |



Power Adaptor

| Code | Length | Lamp Spacing | No. of Lamps |
|-----------------------------|--------|--------------|--------------|
| LED A60 Multi-Colour | | | |
| BL-LV-A60-5M-M | 5m | 500mm | 10 |



BL-LV-A60-5M-M

| Code | Length | Lamp Spacing | No. of Lamps |
|-------------------------------------------|--------|--------------|--------------|
| LED G45 RGB (Auto Colour Changing) | | | |
| BL-LV-G45-5M-RGB | 5m | 500mm | 10 |

BELT LIGHTS

NEW



SOL

Solar Powered LED Belt Light IP65 - c/w 6W, 6V Panel | 240 x 150mm | 1W LED Lamps | Charge Time: 8-10Hrs | Working Time: 13-15Hrs | LiPo 5200mAh Battery | Ideal for Indoor and Outdoor Applications | Colour Temp: 3000K

| Code E27 | Length | Lamp Spacing | No of Lamps | Control Wires |
|-----------------|--------|--------------|-------------|---------------|
| SOL-BL-7.3M-WW | 7,3m | 730mm | 10 | 2 |
| SOL-BL-10.4M-WW | 10,4m | 800mm | 10 | 2 |

NEW

SMART BELT LIGHTS IP56



WiFi RGBIC String W+ Fairy Lights: Power Supply-DC5V | Digital RGB Function

| Code | Type | Watts | No.Lamps (String light + Fairy Light) | Length | Lamp Spacing |
|--------------|------------------------------|-------|---------------------------------------|--------|--------------|
| HH-HM-SSFL15 | String lights + Fairy lights | 10W | 15 + 50 | 15m | 1m/0.3m |

Note: Includes IR Remote controller, power adaptor, IP44 Smart controller and 15m belt light



works with the Google Assistant

WORKS WITH amazon alexa

● R (Red), ● GN (Green), ● BL (Blue), ○ W (White)

Festive
Ornamental

LIGHTING

LED ROPE LIGHTS IP44

| | | | | | | |
|-----------------------------------------------|---------------------------------------------------------------------------------------------------------------------------------------------------------------------------------------------------------------------------|---------------------|---------------------------|--------------|---------------------------|----------|
| 10 000 Hours life | 2-Wire Round | 3-Wire Round | 2-Wire Rectangular | | 3-Wire Rectangular | |
| | | 13mm | 13mm | 5 x 8 | 11 x 18 | |
| ● Red | RL-LED2-*R | RL-LED3-*R | MLF-*R | RE-L2-*R | RE-L3-*R | |
| ● Green | RL-LED2-*G | RL-LED3-*G | MLF-*G | RE-L2-*G | RE-L3-*G | |
| ● Blue | RL-LED2-*B | RL-LED3-*B | MLF-*B | RE-L2-*B | RE-L3-*B | |
| ● Yellow | RL-LED2-*Y | RL-LED3-*Y | MLF-*Y | RE-L2-*Y | RE-L3-*Y | |
| ● Orange | - | - | MLF-*O | - | - | |
| ● White | - | - | MLF-*W | RE-L2-*W | RE-L3-*W | |
| ○ Warm White 2700K | RL-LED2-*WW | RL-LED3-*WW | - | - | - | |
| ○ Day Light 6000K | RL-LED2-*DL | RL-LED3-*DL | - | - | - | |
| Mixed (R, G, Y, B) | RL-LED2-*M | RL-LED3-*M | - | RE-L2-*M | RE-L3-*M | |
| *Add Length to code: 10m or 50m | | | | | | |
| Controller | To be ordered separately | | To be ordered separately | | To be ordered separately | |
| Accessories supplied | All 10 meter Flexi Lights are supplied with: Power Cord, End Cap and 6 piece Mounting Clips All 50 meter Flexi Lights are supplied with: Power Cord, 3 Middle Joint Connectors, 3 End Caps and 30 piece Mounting Clips | | | | | |
| Watts/M | R, Y, M: 1.56W/m B, G, W: 2.6W/m | | | | | |

| Accessories for: | 2-Wire Round | 3-Wire Round | 5 x 8 2-Wire | 11 x 18 2-Wire | 11 x 18 3-Wire | Mounting rails for 5 x 8 LED rope light CH-1PVC CH-2PVC CH-3PVC CH-2PVC CH-3PVC | | | | | | | | |
|----------------------------|-------------------------------------|--------------|-------------------------|----------------|----------------|-------------------------------------------------------------------------------------------------------|--------------------------------------------------------------------------------------------------------------------------------------------------------------------------------------------------------------------------------------------------------------------------------------------------------------------|------|-------------|---------|-------------------|---------|-----------------------------------|---------|
| Power Cord 1.6A | - | - | ML-1.6A | - | - | | <table border="1"> <thead> <tr> <th>Code</th> <th>Description</th> </tr> </thead> <tbody> <tr> <td>CH-1PVC</td> <td>PVC mounting rail</td> </tr> <tr> <td>CH-2PVC</td> <td>Step edge to carpet mounting rail</td> </tr> <tr> <td>CH-3PVC</td> <td>Mounting rail for carpet both sides</td> </tr> </tbody> </table> | Code | Description | CH-1PVC | PVC mounting rail | CH-2PVC | Step edge to carpet mounting rail | CH-3PVC |
| Code | Description | | | | | | | | | | | | | |
| CH-1PVC | PVC mounting rail | | | | | | | | | | | | | |
| CH-2PVC | Step edge to carpet mounting rail | | | | | | | | | | | | | |
| CH-3PVC | Mounting rail for carpet both sides | | | | | | | | | | | | | |
| Converter 4A | - | - | ML-4A | - | - | | | | | | | | | |
| Controller for 10m | WK-220 | WI-310B | - | - | - | | | | | | | | | |
| 8 Function Controller 50m | DK-05-2 | DK-06-4 | SL-210-10A SL-410-2A | DK-05-2-RE | DK-06-4-RE | | | | | | | | | |
| Power Cord c/w Connector | F-1-LED | RL-1-LED | - | SF2-1 | SF3-1 | | | | | | | | | |
| End Caps | F-4 | F-4 | ML-3 | SF2-3 | SF2-3 | | | | | | | | | |
| Coupling (Splice Conector) | F-5 | RL-5 | ML-4 | SF2-4 | SF3-4 | | | | | | | | | |
| Mounting Clip, Plastic | F6 | F6 | ML-5 | SF2-5 | SF2-5 | | | | | | | | | |

| Power Cord 1.6A | | End Cap | | Mounting Clip | | Controller 4A | |
|----------------------------------------|-------|-------------------------------------------|------|---------------|--|---------------|--|
| Rope Length for MLF Series only | | | | | | | |
| Colour | Watts | Max. length with the following converters | | | | | |
| | | 1.6A | 4A | | | | |
| ● White | 2.6W | 160m | 400m | | | | |
| ● Red | 1.56W | 264m | 660m | | | | |
| ● Blue | 2.6W | 160m | 400m | | | | |
| ● Green | 2.6W | 160m | 400m | | | | |
| ● Yellow | 1.5W | 264m | 660m | | | | |

NEW LED ROPE LIGHT WITH CONTROLLER



LED 13mm Ø Special Flexilight IP65 - 230V. (Controller (IP44) to be mounted in weatherproof box)

| Colour | | 3 Wire (3 Colour Chasing) 10m c/w controller |
|---------------------------------------------------------------------------------------------------------|---------|---------------------------------------------------|
| Red, White, Yellow & Blue | ● ○ ● ● | LED-RL-3W-10M |
| Clear / LED DL | | LED-RL-3W-10C-DL (6000K) Daylight |
| Clear / LED WW | | LED-RL-3W-10C-WW (3200K) Warm White |
| Above Flexilights are supplied complete with mains cords, end cap, connector and 8 function controller. | | |
| Colour | | 2 Wire 3-Colour 10m c/w multi-function controller |
| Red, Green, & Blue | ● ● ● | LED-RL-2W-10M |
| Above Flexilights are supplied complete with mains cords, end cap, connector and 8 function controller. | | |

ROPE LIGHTS & CONTROLLERS

13mm Ø Flexilights with Non Fuse Lamps (when one lamp is defective a section of lamps will go off)

13mm Ø Flexilights with Fuse Lamps (when one lamp is defective, only that lamp will go off without affecting a section of lamps)

• 30 000Hrs • 16,5W/M • UV resistant • 240VAC • **IP44**

EXTENDED RANGE

| Colour | 2 Wire Steady/Flashing | 3 Wire Chasing |
|----------------------|------------------------|------------------------|
| Type of Lamps | With Fuse Lamps | With Fuse Lamps |
| Red | IF-2*-R | IF-3*-R |
| Green | - | IF-3-10-G |
| Blue | - | IF-3-10-B |
| Yellow | IF-2-10-Y | IF-3-10-Y |
| Orange | IF-2-10-OR | IF-3-10-OR |
| Neon Green | IF-2*-NG | IF-3-10-NG |
| Neon Orange | IF-2-10-NO | IF-3-10-NO |
| Pink | IF-2*-PK | IF-3*-PK |
| Purple | IF-2*-P | IF-3*-P |
| Mixed (R, G, Y, B) | IF-2*-M | IF-3-10-M |
| Aqua Blue | IF-2*-AB | IF-3*-AB |
| Sakura Pink | IF-2*-SP | IF-3*-SP |



IMPROVED RANGE

*Add Length: 10m or 50m.
Bulb Specification: 36 bulbs/meter 6.5V 0.07A, 0.46W

All 10m Flexilights are supplied complete with mains cords, end cap and connector.

All 50m Flexilights are supplied with 3 x mains cords, 3 x end caps & 3 x connectors.

Controllers to be ordered separately (see below).



Yellow



Aqua Blue



Sakura Pink

Accessories 13mmØ

| Description | Code 2 Wire | Code 3 Wire |
|-------------------------------------------------------------------|-------------|-------------|
| Mains cord c/w connector | F-1 | RL-1 |
| Powercord connector | F-3 | RL-3 |
| End cap | F-4 | F-4 |
| Flexilight Coupling (splice connector) | F-5 | RL-5 |
| Mounting clip | F-6 | F-6 |
| Easy Splice connector with shrink tube | F-7 | RL-7 |
| Y Cord to join 3 lengths | F-9 | RL-9 |
| Suction Cups | F-10 | F-10 |
| T Connector | F-11 | RL-11 |
| PVC Channel – clear, 1 meter length | F-12 | F-12 |
| Waterproof Coupling (splicing kit) to be filled with Silicon Glue | F-14 | RL-14 |
| | F-28 | F-28 |

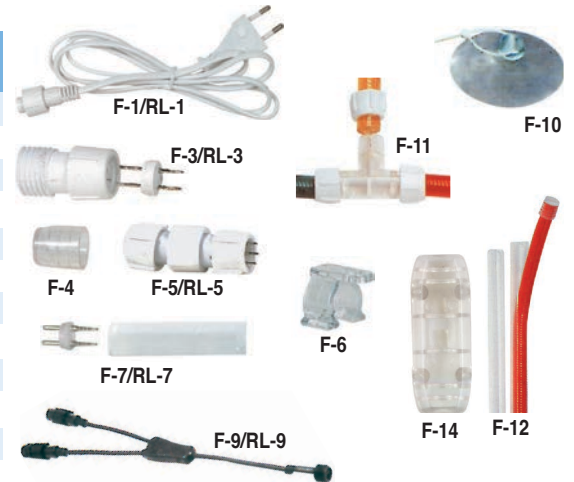

Festive

Controllers 240VAC

| Description | Speed Adj. | Function | Max Loading | Max Amps | Code 2 Wire | Code 3 Wire |
|---------------------|------------|--------------------|-------------|----------|--------------|-------------|
| Indoor IP44 | Yes | Flashing | 17m | 1.2A | WL-220 | - |
| Indoor IP44 | Yes | Chasing | 17m | 1.2A | - | WL-310 |
| Indoor IP44 | Yes | Flashing | 30m | 2.2A | WL-210C | - |
| Indoor IP44 | Yes | Chasing | 30m | 2.2A | - | WL-310C |
| Indoor IP44 | No | 8 Function w/mem | 12m | 1.2A | WL-310B-DI2C | WL-310B |
| Indoor IP44 | Yes | Static, Flashing | 100m | 8A | WL-2C | - |
| Indoor IP44 | Yes | Static, Flashing | 100m | 8A | WL-2C-2P* | - |
| Indoor IP44 | Yes | 6 Function chasing | 100m | 8A | WL-3C-DI2C | WL-3C |
| Indoor IP44 | Yes | 6 Function chasing | 100m | 8A | - | WL-3C-2P* |
| Outdoor IP55 | Yes | 8 Function | 17m | 1.2A | - | WL-310K |
| Outdoor IP55 | No | 8 Function | 30m | 2.2A | - | - |
| Outdoor IP55 | No | 16 Function | 25m | 1.8A | - | WL-318 |



* With 2 Output Connectors for controlling 2 Flexilights, max 100m total length.

LIGHTING

ROPE & FIREWORK FLEXILIGHTS



10mm Ø Flexilight (with fuse lamps) IP65

| Colour | | 2 Wire (Steady/Flashing) 10m |
|------------------------------|---|------------------------------|
| Green | ● | RL2-10-10G |
| Red | ● | RL2-10-10R |
| Yellow | ● | RL2-10-10Y |
| Mini controller for 10m IP44 | | DN-2W-2C |

Accessories

| Code | Description |
|-------|---------------------------------------------------|
| F10-4 | Spare End Cap for 2-wire 10mm diameter Flexilight |
| F1-4 | Mains Cable c/w Connector |

Flexilights are supplied complete with mains cords, end cap and connector.

Controller to be ordered separately see page 177.



Rectangular Flexilight 11mm(H) x 18mm(W) with fuse lamps IP65

| Colour | 11mm 2 Wire Steady/Flashing | 11mm 3 Wire Chasing |
|--------------------|-----------------------------|---------------------|
| Clear | ○ | SF3M-10C |
| Red | ● SF2M-*R | SF3M-50R |
| Green | ● SF2M-10G | SF3M-*G |
| Aqua Blue | ● SF2M-50AB | SF3M-*AB |
| Yellow | ● SF2M-*Y | SF3M-*Y |
| Neon Green | ● | SF3M-10NG |
| Neon Orange | ● | SF3M-10NO |
| Mixed (R, G, B, Y) | SF2M-10M | SF3M-*M |

Accessories

| Description | Code 2 Wire | Code 3 Wire |
|-----------------------------|-------------|-------------|
| Mains Cord and Connector | SF2-1 | SF3-1 |
| End Cap | SF2-3 | SF3-3 |
| Coupling (splice connector) | SF2-4 | SF3-4 |
| Mounting Clips (plastic) | SF2-5 | SF2-5 |
| *Controller for 10m Indoor | WL-220-R | WL-310-R |
| *Controller for 100m Indoor | WL-2C-R | WL-3C-R |

*Add length to code: 10m or 50m Flexilights are supplied complete with mains cords, end cap and connector.

Flexi-Firework is composed of segments of Hollow Flexilight and Flexi-Star fixed on a metal frame. It spreads out at the top of the pillar to create fantastic firework effects. In recent years, Flexi-Firework has become popular all over the world for celebrations, and festive purposes in both small and large scale applications.

| Description | Max. Height of Luminary | Max. Ø of Luminary | Power Consumption 220V-240V | Code |
|------------------|-------------------------|--------------------|-----------------------------|-------------|
| Fountain | 2.4m | 4.5m | 3550W | FA-FW-003-M |
| Tempting Goddess | 3.25m | 3m | 2450W | FA-FW-004-M |
| Jellyfish Star | 2.1m | 3.8m | 2930W | FA-FW-005-M |
| Star War | 2.5m | 3m | 3550W | FA-FW-006-M |
| Forest | 2m | 4.5m | 3550W | FA-FW-008-M |
| Star Fountain | 2m | 3m | 900W | YF-B6014 |
| Festival | 2m | 3m | 900W | YF-B6016 |

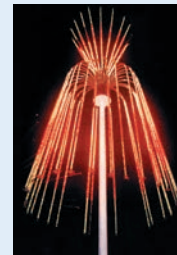

FA-FW-004M

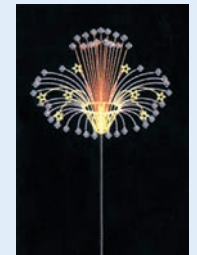

FA-FW-003M



FA-FW-006M

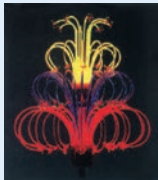

YF-B6016

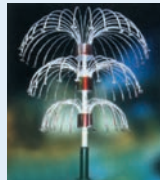

YF-B6014



FA-FW-008M



FA-FW-005M

Pole sold separately

| Code | FA-POLE |
|------|-------------|
| | 3m x 75mm Ø |

LASER PROJECTORS IP44



TOP-A1



Projected Images



TOP-B1



Laser Shower - Input Voltage: 230VAC | c/w Remote, Ground Spike & Tri-Pod | Fairy Light Projection and various images

| Code | Projection | Beam Distance | Coverage | Size |
|--------|-----------------|---------------|---------------------|-----------------|
| TOP-A1 | Red/Green Laser | 30m | 3000ft ² | 240 x 183 x 127 |

Landscape Projector - Input Voltage: 230VAC | c/w Remote, Ground Spike & Tri-Pod | Project Images using slides (Additional Slides to be ordered separately) | Supplied with Slides 3 & 4

| Code | LED | Beam Distance | Coverage | Size |
|--------|------------|---------------|--------------------|-----------------|
| TOP-B1 | 4 x 3W LED | 10m | 600ft ² | Ø95 x 135 x 140 |

TOP-B1 Accessories

| Code | Description | Code | Description |
|---------------|--------------------------|---------------|--------------------------|
| TOP-B1-SLIDE1 | C3 & C4 Slide for TOP-B1 | TOP-B1-SLIDE3 | C1 & C2 Slide for TOP-B1 |
| TOP-B1-SLIDE2 | C5 & C6 Slide for TOP-B1 | TOP-B1-SLIDE4 | C7 & C8 Slide for TOP-B1 |



NEW

LED STRING LIGHT IP44

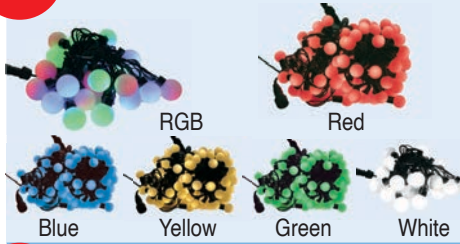

Voltage: 230VAC | Supplied with 1.5m Power Cord | Linkable | Moulded LED Lamps | No Controller required for multi-colour | Suitable for outdoor use

| Code | Wattage | LED Bulbs | Length | Colour |
|-------------------|---------|-----------|--------|-----------|
| ST-102T-5M-50-M | 4.4W | 50 | 5m | RGB (●●●) |
| ST-102T-10M-100-M | 8.8W | 100 | 10m | RGB (●●●) |
| ST-102T-5M-50-* | 4.4W | 50 | 5m | ●●●●○ |

*Add colour to code: ● R (Red), ● Y (Yellow), ● BL (Blue), ● GN (Green), ○ W (White) 6000K

NEW

SMART FAIRY LIGHTS IP56



Globe String Lights Fairy String Lights

WiFi Fairy String Lights: Power Supply-DC5V | Digital RGB Function

| Code | Watts | No. Lamps | Type | Colour |
|--------------|-------|-----------|--------------|-----------------|
| HH-HM-GFLT5 | 5W | 33 | Globe | ●●● Digital RGB |
| HH-HM-FSLT5B | 5W | 50 | Fairy String | ●●● Digital RGB |

Note: Kit includes Remote, Smart Controller, String Fairy Lights and Power Adaptor
● R (Red), ● GN (Green), ● BL (Blue), ○ W (White)

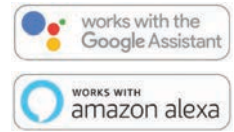
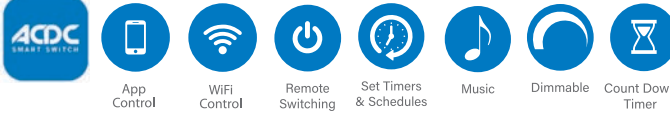

FESTIVE LIGHTS



Flexi-Star Indoor/Outdoor TREE LIGHTS (28 000 hours) 240V

| Code | Colour of Bulb | No. of Channel | Length | No. of Bulbs | Controller Included IP44 | Watts |
|--------------|----------------|----------------|--------|--------------|--------------------------|-------|
| FS2-160C-5* | Clear | 2 | 5m | 160 | 8 Function | 96W |
| FS4-160C-5* | Clear | 4 | 5m | 160 | 16 Function | 96W |
| FS2-160R-5* | Red | 2 | 5m | 160 | 8 Function | 96W |
| FS2-160B-5* | Blue | 2 | 5m | 160 | 8 Function | 96W |
| FS2-160M-5* | Multi | 2 | 5m | 160 | 8 Function | 96W |
| FS2-320C-10* | Clear | 2 | 10m | 320 | 8 Function | 68W |
| FS4-320C-10* | Clear | 4 | 10m | 320 | 16 Function | 68W |
| FS2-320M-10* | Multi | 2 | 10m | 320 | 8 Function | 68W |

*Add colour of wire to code: ● GN (Green), ○ W (White), ○ T (Transparent)

Controller WL-310B with memory. For outdoor use, controller to be mounted in weatherproof box

(25 000 Hours) 240V Indoor use only. Green Wire

| Code | Clear Bulbs | Length | No | W (total) | Controller Included IP44 | Code Multicolour Bulbs |
|----------------|-------------|--------|-----|-----------|--------------------------|------------------------|
| MTL-96B-6M-C | | 6m | 96 | 37W | 8 Function | MTL-96B-6M-M |
| MTL-144B-9M-C | | 9m | 144 | 66W | 8 Function | MTL-144B-9M-M |
| MTL-180B-10M-C | | 10m | 180 | 104W | 8 Function | MTL-180B-10M-M |



Net Light IP44

| Code | Colour of Bulbs | Size | No of Bulbs | Watts | Controller Included IP44 | Code Clear Wire |
|------------|-----------------|----------|-------------|-------|--------------------------|-----------------|
| NL-288-C-G | Clear | 1.5 x 2m | 288 | 96W | 8 Function | NL-288-C-T |
| NL-432-C-G | Clear | 1.5 x 3m | 432 | 115W | 8 Function | NL-432-C-T |
| NL-288-M-G | Multi | 1.5 x 2m | 288 | 96W | 8 Function | NL-288-M-T |
| NL-432-M-G | Multi | 1.5 x 3m | 432 | 115W | 8 Function | NL-432-M-T |

†For outdoor add 'OD' to code. eg ODNL-432-C-G

Ice Light (30 000 Hours) 240V Indoor use only. IP44 extendable

| Code | Green Wire | No. of Channel | Length W H | No. of Bulbs | Power Watts | Controller |
|---------------|------------|----------------|------------|--------------|-------------|------------|
| FI1-90C-2.5GN | | 1 | 2.5m 0.5m | 90 | 45 | Excluded |
| FI1-240C-5GN | | 1 | 5m 1m | 240 | 62 | Excluded |

Curtain Light (30 000 Hours) Indoor use only. IP44 black wire

| Code | Clear Bulbs | Curtain Width x Drop | No of Strings | Lamps per String | W (total) | Extendable Sets Max | Controller Excluded |
|---------------|-------------|----------------------|---------------|------------------|-----------|---------------------|---------------------|
| FC3C-20-2/1 | | 2 x 1.0m | 20 | 36 | 332W | 10 | WL-310C-FC3C |
| FC3C-20-2/1.5 | | 2 x 1.5m | 20 | 36 | 332W | 10 | (2.2A) 506W IP44 |
| FC3C-20-2/5 | | 2 x 5m | 20 | 36 | 332W | 10 | WL-310G-FC3C |
| FC3C-20-2/10 | | 2 x 10m | 20 | 36 | 332W | 10 | (2.2A) 506W IP55 |
| CLS-2X6M | | 2 x 6m | 24 | 74B | 570W | - | WL-3C-FC3C |
| CLS-2X9M | | 2 x 9m | 24 | 111B | 691W | - | (8A) 1840W IP44 |



LED FESTIVE LIGHTS IP44



LED Flexi-Star - Indoor/Outdoor Tree Lights (100 000 hours) 240V

| Code | Colour of Bulb | No. of Channel | Length | No. of Bulbs | Controller Included IP44 | Watts Total |
|---------------|----------------|----------------|--------|--------------|--------------------------|-------------|
| LS2-80WW-8-W | WW (2700K) | 2 | 8m | 80 | 8 Function | 3.2W |
| LS2-100C-12-G | White (5500K) | 1 | 12m | 100 | 8 Function | 9.6W |
| LS2-160C-5-* | White (5500K) | 2 | 5m | 160 | 8 Function | 6.4W |
| LS4-160C-5-* | White (5500K) | 4 | 5m | 160 | 8 Function | 6.4W |
| LS2-160R-5-* | Red | 2 | 5m | 160 | 8 Function | 6.4W |
| LS2-160B-5-* | Blue | 2 | 5m | 160 | 8 Function | 6.4W |
| LS2-160M-5-* | Multi | 2 | 5m | 160 | 8 Function | 6.4W |
| LS2-320C-10-* | White (5500K) | 2 | 10m | 320 | 8 Function | 12.8W |
| LS4-320C-10-* | White (5500K) | 4 | 10m | 320 | 8 Function | 12.8W |
| LS2-320M-10-G | Multi | 2 | 10m | 320 | 8 Function | 12.8W |

*Add colour of wire to code: ● G (Green), ○ W (White), ○ T (Transparent)



LED Net Lights - (100 000 hours) 240V Indoor use only IP44 (extendable)

| Code Black Wire | Code Clear Wire | Code White Wire | Colour of Bulbs | Size | Lamp | | 8 Function Controller |
|-----------------|-----------------|-----------------|-----------------|----------|------|-----------|-----------------------|
| | | | | | No. | W (total) | |
| LFN-252-C-G | LFN-252-C-C | LFN-252-C-W | White (5500K) | 1.5 x 2m | 252 | 16.8W | Included |
| LFN-324-C-G | LFN-324-C-C | LFN-324-C-W | White (5500K) | 1.5 x 3m | 324 | 16.8W | Included |
| LFN-252-M-G | LFN-252-M-C | LFN-252-M-W | Multi | 1.5 x 2m | 252 | 19W | Included |
| LFN-324-M-G | LFN-324-M-C | - | Multi | 1.5 x 3m | 324 | 28W | Included |
| LFN-252-WW-G | LFN-252-WW-C | LFN-252-WW-W | Warm White | 1.5 x 2m | 252 | 19W | Included |
| - | - | LFN-324-WW-W | Warm White | 1.5 x 3m | 324 | 28W | Included |

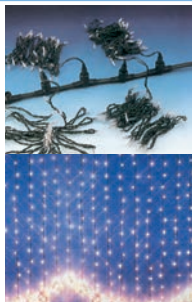

Curtain Light - (100 000 Hours) Indoor use only. IP44 (extendable)

| Code White Bulb (5500K) | Code Warm White Bulb | Curtain Width x Drop | No of Strings | Lamps per String | Watts |
|-------------------------|----------------------|----------------------|---------------|------------------|--------|
| LFC3C-20-2/1* | LFC3WW-20-2/1W | 2 x 1.0m | 20 | 36 | 16.8W |
| LFC3C-20-2/1.5* | LFC3WW-20-2/1.5* | 2 x 1.5m | 20 | 36 | 16.8W |
| LFC3C-20-2/3* | LFC3WW-20-2/3* | 2 x 3m | 20 | 36 | 33.6W |
| LFC3C-20-2/5* | LFC3WW-20-2/5* | 2 x 5m | 20 | 72 | 67.2W |
| LFC3C-20-2/10* | LFC3WW-20-2/10* | 2 x 10m | 20 | 108 | 100.8W |

* Add -W to code for White Wire. Standard items supplied with Black Wire. Controller to be ordered separately. Note IP rating of controller. WL-310B-LFC3C (1.2A) 288W IP44. WL-310K-LFC3C (1.2A) 288W IP55

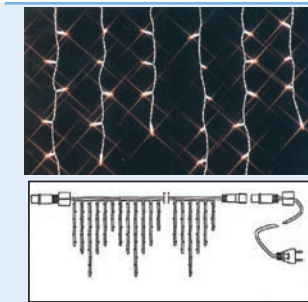

Icicle Light - (100 000 Hours) 240V Indoor use only. IP44 extendable

| Code | No. of Channel | Length | | No. of Bulbs | Power Watts | Controller Included |
|---------------|----------------|--------|------|--------------|-------------|---------------------|
| | | W | H | | | |
| LF11-60*-1.7* | 1 | 1.7m | 0.5m | 60 | 4.8W | Excluded |
| LF11-90*-2.5* | 1 | 2.5m | 0.5m | 90 | 4.8W | Excluded |
| LF11-240*-5* | 1 | 5m | 1m | 240 | 9.6W | Excluded |
| LF11-250-WW-W | 1 | 3.5m | 1m | 250 | 9.6W | Excluded |
| LF14-240*-5* | 4 | 5m | 1m | 240 | 9.6W | 8 Function |

*Add colour to code: ○ C (Cool White 5500K) , ○ WW (Warm White)

*Add colour of wire to code: ● GN (Green), ○ W (White), ○ T (Transparent)

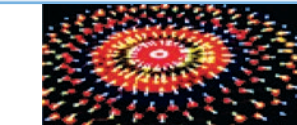

LED Round Sparkle Net Lights - (100 000 hours) 240V Indoor use only

| Code Green Wire | Colour of Bulbs | Type | Size | LED Quantity | Controller Included |
|-----------------|-----------------|---------|------|--------------|---------------------|
| CM-RNL-C | White | Chasing | 1m Ø | 80 | 2 Function |
| CM-RNL-M | Multi | Chasing | 1m Ø | 80 | 8 Function |

LED Extendable Flexi-Star - (100 000 hours) Indoor/Outdoor use. PVC wire. IP44

| Code Green Wire | Colour of Bulb | No. of Bulb | | | | Power Consumption | | | | Max. Extendable Set | | | |
|-----------------|----------------|-------------|-----|-----|-----|-------------------|-----|------|--------|---------------------|-----|-----|---------|
| | | 5m | 10m | 12m | 50m | 5m | 10m | 12m | 50m | 5m | 10m | 12m | 50m |
| LRS2-100C-*-* | White (5500K) | - | - | 100 | 500 | - | - | 7.6W | 38.14W | - | - | 20 | 4(sets) |
| LRS2-100M-*-* | Multi | - | - | 100 | 500 | - | - | 7.6W | 38.14W | - | - | 20 | 4(sets) |
| LRS2-160C-12-* | White (5500K) | 160 | - | 160 | 800 | 9.6W | - | 9.6W | 48W | 20 | - | 20 | 4(sets) |
| LRS2-160C-50-G | White (5500K) | 160 | - | 160 | 800 | 9.6W | - | 9.6W | 48W | 20 | - | 20 | 4(sets) |
| LRS2-160M-*-* | Multi | - | - | 160 | 800 | - | - | 9.6W | 48W | - | - | 20 | 4(sets) |

LED Flexi-Star - (100 000 hours) Indoor/Outdoor use. PVC wire. IP44

| Code | Colour of Bulb | No. of Bulb | Power Consumption | Max. Extendable Set |
|----------------|----------------|-------------|-------------------|---------------------|
| LRS2-160C-5-G | White (5500K) | 160 | 9.6W | Not Extendable |
| LRS2-320C-10-* | White (5500K) | 320 | 19.2W | Not Extendable |
| LRS2-320M-10-G | Multi | 320 | 19.2W | Not Extendable |

*Add length to code: 5 (5m), 12 (12m) or 50 (50m) | *Add colour of wire to code: ● G (Green), ○ W (White)

*Add colour of wire to code: ● G (Green), ○ W (White), ○ T (Transparent)

LED FESTIVE LIGHTS

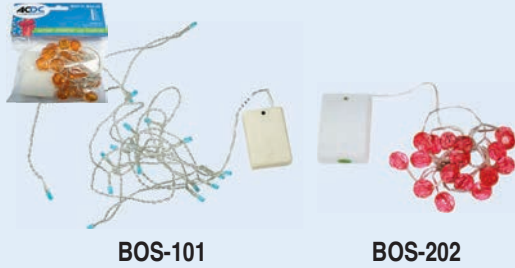

Battery Operated Starlight - Indoor use only | 2 Wire LED light string with white battery box | Wire colour: Silver | Length: 2 meter | 20 LEDs in a 2 meter Length | Approximate battery life: 72 HRS (Dependant on type of battery)

| Code | Description | *Add Colour to Code |
|-----------------|---------------------------------------------------------|---------------------------------------------------------------------------------------------------------|
| BOS-101* | Battery operated LED flexistar | ○ WW (Warm White), ○ CW (Cool White), ● R (Red), ● BL (Blue), ● GN (Green), ● Y (Yellow), ● G (Gold) |
| BOS-202* | Battery operated LED flexistar with clear crystal balls | ○ WW (Warm White), ○ CW (Cool White), ● R (Red), ● BL (Blue), ● GN (Green), ● Y (Yellow), ● OR (Orange) |

SOLAR FESTIVE LIGHTS IP44

3 Levels on timer: 6h, 8h and 10h adjustable | Working time after full charge: 20-40hrs (time for full charge: 8hrs in direct sunlight) | Charging period for one night (±8-16hrs): 4hrs in direct sunlight | On/Off: automatically turn on at 75±25lx, turn off at 350±50lx in one minute by photo sensor

Solar panel with intergrated controller

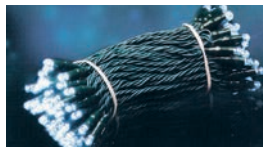

Solar LED String Light



Solar Icicle Light

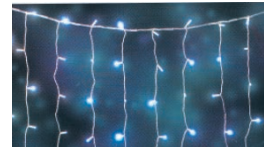

Solar Curtain Light



Solar Net Light

| Code | TEA-7D02-B05-* | TEA-7D02-B10-* | TEA-7D06-B10-* | TEA-7D06-B20-* | TEA-7D08-B10-* | TEA-7D08-B20-* | TEA-7D10-B20-* |
|------------|----------------|----------------|----------------|----------------|----------------|----------------|----------------|
| Length (m) | 5 | 10 | 1.6 x 0.6 | 2.0 x 1.0 | 1.6 x 0.6 | 2.0 x 1.4 | 1.6 x 0.6 |
| No of LEDs | 50Pcs | 100Pcs | 96Pcs | 200Pcs | 96Pcs | 200Pcs | 96Pcs |

*Add colour to code: ○ CW (Cool White), ●●● M (RGB)

LED FESTIVE LIGHTS IP44



LED Clip Light

| Code | LEDs | Watt | Colour | Description |
|-------------------------|---------|--------|--------|------------------------------------------------------------------------------------|
| LCLT-*G-RGB | 160/10m | 7W/10m | RGB | LED RGB Clip light colour changing; c/w 8 function controller; 4 wire |
| LCLT-*G-RGB-AUTO | 160/10m | 7W/10m | RGB | LED RGB clip light auto colour changing; with controller to control fading; 2 wire |
| LCLT-*G-WW | 160/10m | 7W/10m | White | LED warm white clip light c/w transformer; no controller; 2 wire |
| LCLT-*G-PW | 100/10m | 7W/10m | White | LED pure white clip light c/w transformer; no controller; 2 wire |

*Add length to code: **10** (10m), **50** (50m), **100** (100m)

LED Knitting Lights

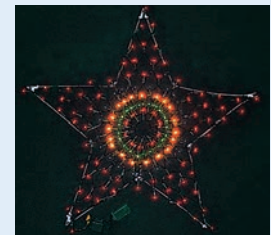

| Code | CM-STR-M |
|---------------------------------------------------------------------------------------------------------------------|----------|
| 80 Red, 20 Green, 20 Yellow & 20 Blue LED's. Complete with 8 function Controller. Voltage: 240V. Size: 910 x 910mm. | |

LED TUBE EFFECT LIGHTING

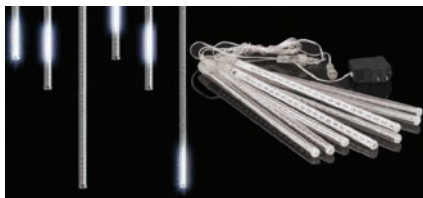

LED Falling Star Effect Tubes - Input Voltage: 220VAC

| Code | Effect | 1 Kit | Size (mm) | LED's/Tube |
|-----------------------|---------|-------|--------------|------------|
| RW-LK30-18-* | Chasing | 8Pcs | Ø12 x 300(L) | 18 LED's |
| RW-LK50-30-* | | | Ø12 x 500(L) | 30 LED's |
| RW-LK60-33-* | | 5Pcs | Ø12 x 600(L) | 33 LED's |
| RW-LK60-33-RGB | | | Ø12 x 600(L) | 33 LED's |

Kit includes connecting cables and mains adaptor | *Add colour to code: ● R (Red), ● GN (Green), ● Y (Yellow), ● BL (Blue), ○ WH (White)

LED BALL MOTIF



LED-LBL-220L-*



LED-LBL-80L-*

Smart LED Christmas Tree

| Code | Description |
|-----------------------|-----------------------------------------------------|
| LED-LBL-220L-* | Ø600mm Ball motif with 150 LEDs, black wire, Indoor |
| LED-LBL-80L-* | Ø300mm Ball with 55 LEDs, black wire, Indoor |

*Add LED colour to code: ○ W (White), ● R (Red), ● GN (Green), ● Y (Yellow), ● BL (Blue)

SMART XMAS TREE



Input Voltage: 100-240VAC
100+ Light Shows App Controlled | RGB, 16 million colours | 2.4G Wifi | c/w Controller

| Code | FI-710 |
|----------------------|--------|
| No. of Strings | 7 |
| No. of LEDs / String | 10 |
| String Length | 140cm |
| Max Wattage | 15W |

NEW

3D LED MOTIFS



| | | | | | |
|---------|---------------|---------------|---------------|---------------|---------------|
| Code | SM-I-001-220V | SM-I-002-220V | SM-I-003-220V | SM-I-065-220V | SM-I-066-220V |
| Size | 1200 x 1000mm | 2100 x 1300mm | 1200 x 800mm | Ø300mm | Ø600mm |
| Wattage | 77W | 115W | 77W | 4W | 8W |



| | | | | |
|---------|---------------|---------------|---------------|----------------|
| Code | SM-I-007-220V | SM-I-008-220V | SM-I-009-220V | SM-I-077A-220V |
| Size | 1000 x 650mm | 600 x 830mm | 400 x 360mm | 3500 x 1100mm |
| Wattage | 35W | 35W | 8W | 115W |

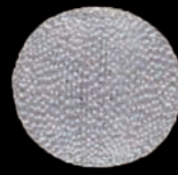
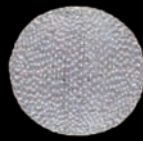

| | | | | |
|---------|----------------|----------------|----------------|---------------|
| Code | SM-I-072A-220V | SM-I-072B-220V | SM-I-072C-220V | SM-I-057-220V |
| Size | Ø400mm | Ø600mm | Ø800mm | Ø400mm |
| Wattage | 16W | 23W | 27W | 8W |



| | | | | |
|---------|-------------------|-------------------|-------------------|--------------|
| Code | SM-I-045A-220V | SM-I-045B-220V | SM-I-045C-220V | PHS-084-220V |
| Size | 420 x 400 x 260mm | 320 x 400 x 260mm | 200 x 200 x 160mm | 600 x 550 mm |
| Wattage | 6W | 3W | 2.5W | 60W |

NEW

LASER ETCHED ACRYLIC MOTIF



| | | | |
|---------|-----------------|-----------------|-----------------|
| Code | SM-C-002-220V-* | SM-C-001-220V-* | SM-C-003-220V-* |
| Size | 330 x 310mm | 330 x 310mm | 450 x 430mm |
| Wattage | 5W | 5W | 5W |

*Add colour to code: ○ CW (Cool White), ● R (Red), ● BL (Blue), ● GN (Green)

3D LIGHT MOTIF WITH STANDARD (28 000hr) LAMPS



| Code | BLM-1103 | BLM-1105 | BLM-1106 | BLM-1107 | BLM-1111 |
|---------|-------------|-------------|-------------|--------------|--------------|
| Size | 640 x 450mm | 440 x 720mm | 920 x 870mm | 1120 x 690mm | 400 x 1300mm |
| Wattage | 98.28 | 10.2 | 212.94 | 180.18 | 37.4 |

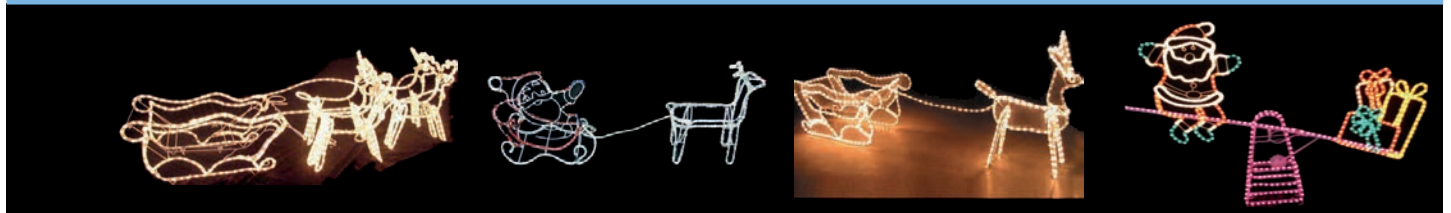

| Code | BLM-1113 | BLM-1114 | BLM-1115 | BLM-1118 |
|---------|--------------|--------------|--------------|--------------|
| Size | 780 x 2400mm | 530 x 1300mm | 530 x 1100mm | 650 x 1400mm |
| Wattage | 54.4W | 196.8W | 23.8W | 213.2W |

MINI ROPE LIGHT MOTIF WITH STANDARD (28 000hr) LAMPS

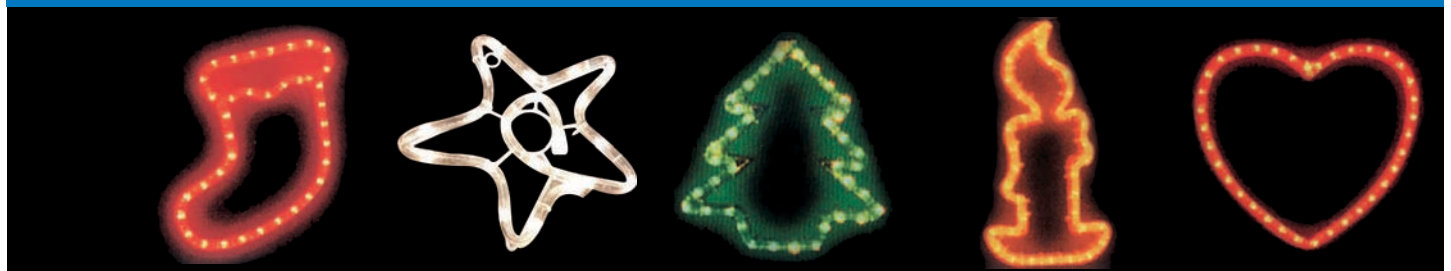

| Code | DNM-003 | DNM-007 | DNM-009 | DNM-012 | DNM-013 |
|---------|-------------|-------------|-------------|-------------|-------------|
| Size | 250 x 330mm | 230 x 290mm | 260 x 340mm | 170 x 410mm | 350 x 340mm |
| Wattage | 1.7W | 1.7W | 1.7W | 1.7W | 1.7W |

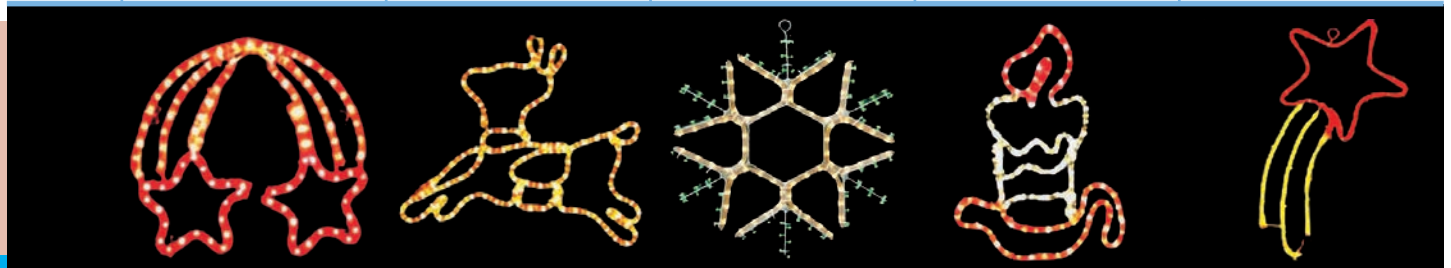

| Code | NL-202 | NL-105 | NL-301 | NL-201 | NL-104 |
|---------|-------------|-------------|--------|-------------|-------------|
| Size | 360 x 420mm | 400 x 500mm | Ø410mm | 500 x 380mm | 560 x 440mm |
| Wattage | 8.5W | 6.8W | 6.8W | 5.1W | 6.8W |



| Code | BLM-1201* | BLM-1205 | BLM-1206 | LTL-CHERRY-1.8M-WW |
|---------|-------------|----------|----------|--------------------|
| Size | 1200mm | 800mm | 1200mm | 1800mm |
| Wattage | 58W | 8W | 8W | 6W |
| Colour | White/Black | White | White | Cherry |

*add -BK to code for Black

Festive

LIGHTING

3000K

MINI ROPE LIGHT MOTIF WITH STANDARD (28 000hr) LAMPS



| Code | NL-205 | NL-303 | NL-204 | NL-113 | NL-112 |
|---------|-------------|-------------|-------------|-------------|-------------|
| Size | 570 x 380mm | 600 x 340mm | 640 x 480mm | 640 x 480mm | 640 x 550mm |
| Wattage | 5.1W | 6.8W | 8.5W | 6.8W | 8.5W |



| Code | NL-527 | NL-116 | NL-535 | NL-504 | NL-525 |
|---------|-------------|-------------|-------------|-------------|-------------|
| Size | 650 x 850mm | 680 x 480mm | 750 x 580mm | 750 x 750mm | 730 x 930mm |
| Wattage | 147.6W | 8.5W | 11.9W | 15.3W | 13.6W |

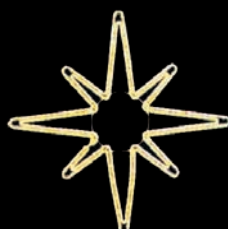

| Code | NL-503 | NL-524 | NL-306 | NL-305 | NL-307 |
|---------|-------------|-------------|-------------|-------------|-------------|
| Size | 800 x 800mm | 800 x 800mm | 810 x 810mm | 930 x 780mm | 930 x 730mm |
| Wattage | 11.9W | 13.6W | 10.2W | 10.2W | 212.94W |



| Code | NL-519 | NL-312 | NL-542 | NL-543 | NL-514 |
|---------|--------------|--------------|--------------|--------------|---------------|
| Size | 1080 x 820mm | 1100 x 750mm | 1200 x 783mm | 1200 x 870mm | 1200 x 1200mm |
| Wattage | 6.2W | 327.6W | 13.6W | 18.7W | 377.2W |

• Indoor/Outdoor use • 2 Wire Connection • Supplied without controller, for controllers see page 177.

MINI ROPE LIGHT MOTIF WITH STANDARD (28 000hr) LAMPS



| Code | NL-528 | NL-401 | NL-604 | NL-626 | NL-630 |
|---------|---------------|---------------|--------------|---------------|---------------|
| Size | 1230 x 1110mm | 1330 x 1110mm | 1500 x 700mm | 1530 x 1000mm | 1900 x 1300mm |
| Wattage | 278.46W | 393.6W | 147.42W | 18.7W | 458.64W |



| Code | NL-605 | NL-606 | NL-614 | NL-624 |
|---------|---------------|---------------|---------------|--------------|
| Size | 2000 x 1000mm | 2000 x 1100mm | 2000 x 1100mm | 2500 x 900mm |
| Wattage | 13.6W | 15.3W | 15.3W | 295.2W |



| Code | NL-622 | NL-609 | NL-545 | NL-314 | NL-636 |
|---------|---------------|---------------|--------------|--------------|---------------|
| Size | 2500 x 1100mm | 3400 x 1200mm | 600 x 1400mm | 730 x 1850mm | 2000 x 1500mm |
| Wattage | 278.8W | 687.96W | 164W | 229.32W | 606.8W |



| Code | NL-417 | NL-638 | NL-639 | NL-660 | NL-643 |
|---------|---------------|---------------|---------------|---------------|---------------|
| Size | 1000 x 2000mm | 1100 x 1500mm | 1200 x 1500mm | 1000 x 3500mm | 1300 x 3500mm |
| Wattage | 311.6W | 30.6W | 344.4W | 492W | 752W |



| Code | NL-648 | NL-654 | NL-655 | NL-661 |
|---------|---------------|---------------|---------------|---------------|
| Size | 1500 x 3320mm | 1000 x 4000mm | 1200 x 6200mm | 1000 x 4000mm |
| Wattage | 606.80W | 557.6W | 967.60W | 820W |

• Indoor/Outdoor use • 2 Wire Connection • Supplied without controller, for controllers see page 177.

Festive

LIGHTING

LED DISPLAYS



c/w DIM-CG-100
universal dimmer

| Code | LED-DISPLAY1 | LED-DISPLAY2 | LED-DISPLAY3 | LED-DISPLAY3-DIM |
|--------------|-----------------------------------------------------------------|---------------------------------------------------------------------|-----------------------------------------------------------------|------------------|
| Size (mm) | 370(W) x 284(H) x 120(D) | 370(W) x 284(H) x 120(D) | 400(W) x 400(H) x 125(D) | |
| Lamp Holders | 5 x 230V Sockets | 4 x 230V Sockets + 1 x 12VAC Socket | 5 x 230V (E27) Sockets | |
| Description | This Display is for 230V AC/DC Dynamics CFL and LED Lamps only. | This Display is for 230V/12V AC/DC Dynamics CFL and LED Lamps only. | This Display is for 230V AC/DC Dynamics CFL and LED Lamps only. | |

LED SHELF LIGHT C/W GLASS

Shelf with LED Edge Lighting - 230VAC | Housing Material: Aluminium

| Shelf Material: Glass

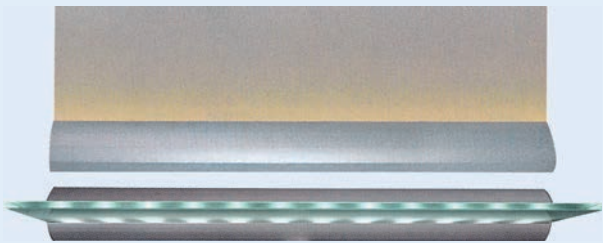

| Code | Lamp | Size (mm) |
|--------------|------|-------------------|
| EL201001-45* | 1.8W | 450L x 180W x 60H |
| EL201001-60* | 2.5W | 600L x 180W x 60H |
| EL201001-90* | 3W | 900L x 180W x 60H |

*Add colour to code: ○ CW (Cool White), ● R (Red), ● GR (Green),
● BL (Blue), ● Y (Yellow)

LED SHOWER HEADS

| | | | | |
|---------------------------------------|-------------------------------------------------------------------------|-------------------------------------------------------------------------------------------------------------------------------------------------------------------------------------------------------------------|-------------------------------------------------------------------------------|-------------------------------------------------------------------------------|
| No battery required 100% water driven | | | | |
| | Code | SHL003 | SHL004 | SHL005 |
| | Mode | Temperature Controlled | Temperature Controlled | Temperature Controlled |
| | Features | Blue: Under 30°C, Pink: 31 - 40°C Red: 41 - 50°C, Red Flashing: Above 50°C | Blue: Under 30°C, Pink: 31 - 40°C Red: 41 - 50°C, Red Flashing: Above 50°C | Blue: Under 30°C, Pink: 31 - 40°C Red: 41 - 50°C, Red Flashing: Above 50°C |
| | Size (mm) | Ø200 x 10 | 200 x 200 x 10 | 300 x 300 x 10 |
| No battery required 100% water driven | | | | |
| | Code | LED SH-MC | LED SH-RGB | |
| | Mode | Multi Colour | RGB Colour (Temperature Indicating) | |
| Features | When water flows the LED will light up and colour will change gradually | When water flows the LED will light up, Green when temperature is ≤ 25°C, Blue when temperature is between 26°C - 35°C, Red when temperature is between 36°C - 45°C. Red will flash when temperature exceeds 46°C | | |

LED STAGE LIGHTS

For single colour, 2 channel DMX Strobe/ Dimmer

LED PAR 46 - 5 Channel DMX Controller



LED PAR 56 - 5 Channel DMX Controller



LED PAR 64 - 4 Channel DMX Controller



| Code | LDP-005-* | LDP-006-* | LDP-007-* | LDP-008-* |
|-------------|--------------------------------------------------------------------------------------|--------------------------------------------------------------------------|------------------------------------------------------------------------------------------------------------------------|--------------------------|
| Size (mm) | 190 x 190 x 330 | 210 x 210 x 310 | 230 x 230 x 320 | 230 x 230 x 400 |
| LED's | 94 x 0.16 (15W) | 107 x 0.19 (20W) | 177 x 0.17 (30W) | 177 x 0.17 (30W) |
| IP Rating | IP33 | IP33 | IP33 | IP33 |
| Description | Long Can Control Mode: DMX, Stand Alone, Master & Slave, Sound Activated and Auto | Control Mode: DMX, Stand Alone, Master & Slave, Sound Activated and Auto | Short Can with Dip Switch DMX512 Signal, 4 Channels, including Auto, Strobe, Master-Slave and synchronously running | Long Can with Dip Switch |

*Add colour to code: ● **R** (Red), ● **BL** (Blue), ● **Y** (Yellow), ● **GN** (Green), ○ **CW** (Cool White), ○ **WW** (Warm White)

High Power LED PAR 64



High Power LED PAR 64



PAR 64 Empty Can



Lamp for PAR 64 Can

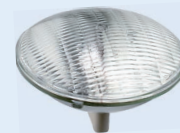

Colour Gels for PAR 64

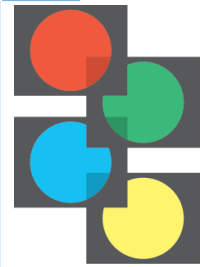

| Code | LDP-011-* | LDP-012-* | LDP-015-* | RTL-19 | PAR64-* | PARGEL-* |
|-------------|--------------------------------------------------------------------------------------|-----------------|-------------------------------------------|---------------------------------------------------------|-----------------------------------|---------------------------------------|
| Size (mm) | 230 x 230 x 360 | 230 x 230 x 360 | 305 x 305 x 340 | 255 x 226 x 445 | Ø 8" | Sheet size: 100x80cm |
| LED's | 36 x 1W(36W) | 36 x 3W(108W) | 36 x 1W(36W) | 1000W | 1000W (Halogen) | |
| IP Rating | IP33 | IP33 | IP65 | IP33 | | |
| Description | 6 DMX Channels. Aluminium PAR Can. Auto, Strobe, Master Slave, Synchronously Running | | 6 DMX Channels Digital Display Waterproof | Lamp to be Ordered Separately c/w Frame for Colour Gels | Colour Gels to Ordered Separately | Red, Green, Blue and Yellow Available |

*Add colour to code: ● **R** (Red), ● **BL** (Blue), ● **Y** (Yellow), ● **GN** (Green), ○ **CW** (Cool white), ○ **WW** (Warm White), ●●● **RGB**

* Add type to code:
MF (Medium Flood),
WF (Wide Flood),
NS (Narrow Spot)

*Add colour to code:
● **R** (Red), ● **BL** (Blue),
● **Y** (Yellow),
● **GN** (Green)

Search Lights with Moving Head with DMX



Colour Changing City Light



| Code | RTL47 | RTL48 | RTL54B |
|-------------|------------------|-----------------|----------------------|
| Size (mm) | 880 x 790 x 1200 | 940 x 80 x 1250 | 810 x 620 x 730 |
| Wattage | 7kW | 10kW | 2.5kW |
| IP Rating | IP54 | IP54 | IP54 |
| Supply V/A | 230V/30.4A | 230V/43.4A | 230V/10.8A |
| Description | DMX | DMX | 7 Channels. DMX. CMY |

Flight Cases included in all the above

Stage

LIGHTING

STAGE LIGHTS

| | | | | | |
|-------------|-----------------------------------------------------------------------------------------------------------------------------------------------|-----------------------------------------------------------------------------------------------------------------------------------------------------|--------------------------------------------------------------------------------------------------------------------------------|---------------------------------------------------------------------------------------------------------------------------------|---------------------------------------------------------------------------------------------------------------------|
| | <p>LED 4-eyes Whirlwind Light</p>  | <p>3-Output Laser Effect LED</p>  | <p>LED Flowing Light</p>  | | |
| Code | LDE-027 | LDE-031 | LDE-015 | | |
| Size (mm) | 500 x 300 x 140mm | 350 x 250 x 170mm | 375 x 345 x 210mm | | |
| LED's | 180 x Ø5 RGB (40W) | 192 x Ø5 RGB (20W) | 96 x Ø5mm (15W) | | |
| Description | 11 DMX Channels, Master/Slave | Sound activated, Auto, 6 DMX channels | DMX512 signal, 4 channels including Auto, Strobe, Master/Slave, Synchronously running | | |
| | <p>LED Moving Head Effect Light</p>  | <p>LED Vertigo</p>  | <p>4 x 55W Soft Light</p>  | <p>Firefly Laser</p>  | <p>Crystal Ball LED</p>  |
| Code | LDE-019 | LDE-033 | AVL37 | SML-011 | LDE-103 |
| Size (mm) | 220 x 170 x 290mm | 410 x 280 x 280mm | 635 x 290 x 110mm | 285 x 100 x 135mm | Ø182 x 156mm |
| LED's | 84 x 0.14 (12W) | 224 x Ø5 (50W) | – | Green 532 nm: 100mW | 3 x 4W |
| Description | DMX512 signal, 4 channels including Auto, Strobe, Master/Slave, Synchronously running | Sound activated, Auto, Master/ Slave | Fluorescent | DMX512, Sound activated, Auto | DMX512, channels sound activated, auto |
| | <p>Green Intelligent Laser with ILDA Interface</p>  | <p>Firefly Laser Light with Colour Changing LED Wash</p>  | <p>LED Super Mini Strobe Light</p>  | <p>LED Waterproof Strobe Light</p>  | |
| Code | AV-G100 | SML-032 | LDE-022-* | LDE-023-* | |
| Size (mm) | 400 x 300 x 150mm | 290 x 190 x 135mm | 130 x 85 x 55mm | 240 x 200 x 120mm | |
| LED's | Green 532nm: 100mW | Laser: Green 60mW Red 100mW LEDs: 1x Red, 1x Green, 1x Blue 1W | 24 x Ø5mm (5W) | 116 x Ø10mm (20W) | |
| Description | DMX512, Sound activated, Auto | 8 DMX channels, Sound activated, Auto, master/ Slave | With speed adjustability | Strobe, Sound activated, both speed adjustable | |
| | | | *Add colour to code: ● R (Red), ● GN (Green), ● BL (Blue), ● Y (Yellow), ○ CW (Cool White) | | |



LONGMEADOW

26 Nguni Drive, Longmeadow
Business Estate West, Edenvale
Gauteng

Tel: +27 10 202 3300
Fax: +27 10 202 3365
Email: info@acdc.co.za

GERMISTON

Sharland Street, Driehoek,
Germiston, Gauteng

Tel: +27 11 418 9600
Fax: +27 11 418 9633
Email: germiston@acdc.co.za

CAPE TOWN

Richmond Southern Close, Lenie
Adams Avenue, Richmond Park

Tel: +27 21 492 2000
Fax: +27 87 807 5279
Email: cape@acdc.co.za

PAARDEN EILAND

55 Section Street, Paarden Eiland,
Cape Town

Tel: +27 21 036 0996
Email: thomash@acdc.co.za

PINETOWN

Unit 10, Pine Industrial Estate
Pineside Road, New Germany
Pinetown, Kwa-Zulu Natal

Tel: +27 31 700 4215
Fax: +27 31 700 4330
Email: kzn@acdc.co.za

RIVERHORSE

6 Riverhorse Close Riverhorse
Valley Business Estate,
Durban, Kwa-Zulu Natal

Tel: +27 31 492 4800
Fax: +27 87 405 0775
Email: rvh@acdc.co.za

FOLLOW US ON SOCIAL MEDIA

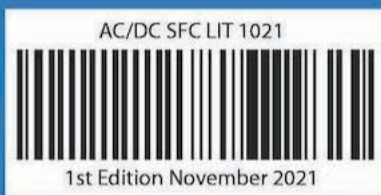

Specifications are subject to change from time to time,
without notification in this publication.

© ACDC Dynamics 2022

THINK ELECTRICAL